

 **GEARWRENCH®**

GET IT DONE.™



THE Evolution of Innovation

THE GEARWRENCH HAND TOOL LINE

GearWrench® hand tools are warranted for Life to be free of defects in material and workmanship. Carrying cases, pouches, accessory bits and consumable products, if any, are not covered by this Warranty.

If use of any GearWrench Hand Tool® when used for its intended purpose, fails to give complete satisfaction, return it to your GearWrench Distributor or contact Danaher Tool Group Professional Division at (800)-688-8949, and it will be repaired or replaced free of charge. *Except Torque Products

*GearWrench Torque Products are warranted to (1) be free of defects in material and workmanship for one year and (2) meet out of the box calibration accuracy standards as stated in the product literature. Accuracy standards for calibration are warranted for 90 days from date of purchase. Products for which Warranty Repair is requested should be returned, at Buyer's cost, for evaluation to:

Warranty Service & Authorized Repair:
Electronic Torque Wrenches
DTG Torque Repair
3000 West Kingsley Road
Garland, TX 75041

All other Torque Products
Angle Repair & Calibration Service, Inc.
175 Angle Drive
Beckley, West Virginia 25801

GearWrench Torque Products are precision instruments that contain moving parts. These components are subject to normal wear through use and replacement thereof is the responsibility of Buyer. Torque Products should be routinely checked for calibration at an Authorized Repair Center using GearWrench repair parts.

This Warranty shall not apply to Products which have been misused, abused, damaged by accident or otherwise, repaired by anyone other than an Authorized Repair Center or modified by anyone other than Danaher Tool Group and is in lieu of all other warranties, whether express, implied or statutory. THE IMPLIED WARRANTIES OF MERCHANTABILITY AND FITNESS FOR A PARTICULAR PURPOSE ARE SPECIFICALLY EXCLUDED. Buyer's sole and exclusive remedy for breach of this Warranty is, at the option of Danaher Tool Group, repair or replacement of the defective Product. IN NO EVENT WILL DANAHER TOOL GROUP BE LIABLE FOR ANY INDIRECT, SPECIAL, INCIDENTAL, CONSEQUENTIAL OR PUNITIVE DAMAGES ARISING FROM BREACH OF THIS WARRANTY, EVEN IF DANAHER TOOL GROUP HAS BEEN ADVISED OF THE POSSIBILITY OF SUCH DAMAGES.

The Danaher Tool Group is not responsible for personal injury or damage resulting from improper tool usage, product modification, abuse or usage beyond expected product life.

For further information on GearWrench Hand Tools, Torque Products or Authorized Repair Centers, please contact us at:

Danaher Tool Group
GearWrench Professional Hand Tools
14600 York Rd, Suite A
Sparks, MD 21152
Web/email - www.gearwrench.com

Phone Numbers
Professional Customers (800) 866-5753
Retail/Consumer Customers (888) 757-1812

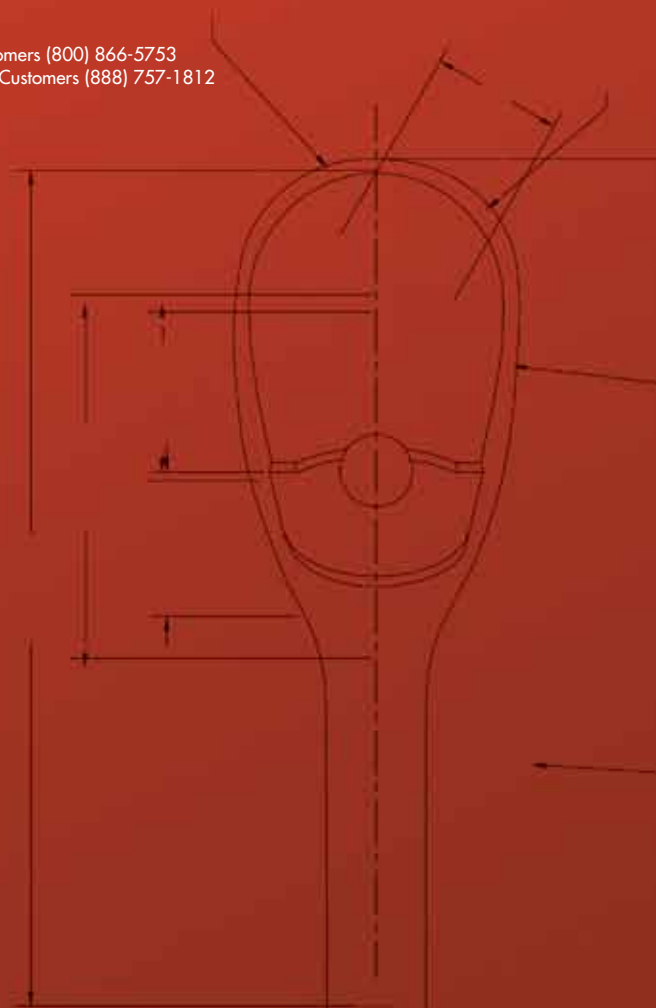
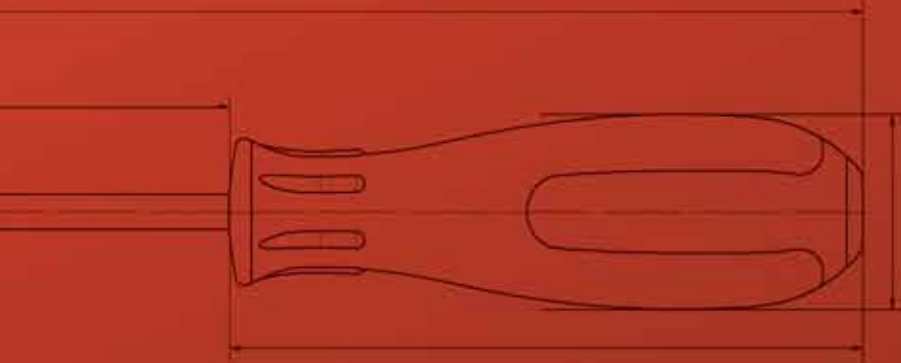

GEARWRENCH® is a registered trademark of EASCO Inc., a Danaher Tool Group Company.

GearBox™, X-Beam™, Quadbox™, Vortex™, Pass-Thru®, GearPlier™, Double-X™, and GearDriver™ are trademarked registered brands of Danaher Corporation.

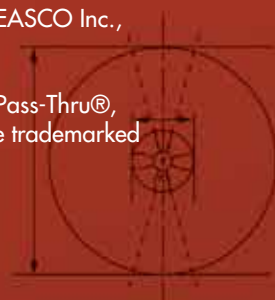









Danaher Tool Group
Sparks, MD 21152

Customer Service
Phone: 800-688-8949
Fax: 800-234-0472

www.gearwrench.com

TABLE OF CONTENTS

TECHNICAL EDUCATION SETS	11	
TOOL STORAGE	27	
RATCHETS, SOCKETS AND DRIVE TOOLS	37	
BIT SOCKETS AND FLEX HEX™ KEYS	131	
IMPACT SOCKETS	159	
WRENCHES	193	
TORQUE WRENCHES	267	
SCREWDRIVERS AND NUTDRIVERS	271	
PLIERS	301	
PRYBARS	319	
STRIKING AND STRUCK TOOLS	323	
RATCHETING TAPS AND DIES	333	
CUTTING TOOLS	345	
SPECIALTY AND GENERAL PURPOSE TOOLS	349	
INDEX	357	



THE EVOLUTION OF INNOVATION



GearWrench started when we developed a ratcheting wrench that stood up to professional environments

As more professionals began to use ratcheting wrenches, we spent time solving more access problems and introducing other wrench styles

Having success in wrenches, we began to integrate ratcheting mechanisms into screwdrivers and other traditionally non-ratcheting tools

1996

1997

1998

1999

2000

2001

2002

2003

COMBINATION RATCHETING WRENCH



DOUBLE BOX RATCHETING WRENCH



STUBBY RATCHETING WRENCH



REVERSIBLE RATCHETING WRENCH



FLEXIBLE RATCHETING WRENCH



GEARRATCHET VORTEX SOCKET SYSTEM



GEARDRIVER INTERCHANGABLE SHAFT SYSTEM



Starting with the "Original" combination ratcheting wrench, we quickly expanded to stubby and double box as these were traditional non-ratcheting wrench configurations

The Reversible and Flex style wrenches were born from user feedback, with an eye for how to work in tight spaces.

By 2002, we had sold over 100 million wrenches and earned a name for producing the highest quality tools at a great value



GearWrench has received numerous industry awards for producing productivity tools such as GearPlier®, Magnetic Oil Drain Plug sockets, X-Beam Ratcheting Wrenches, & Indexing Pry Bars.

In 2006, GearWrench introduced the broadest line expansion in its history with the addition of award-winning ratchets, sockets, screwdrivers, pliers, and torque wrenches

GearWrench has continued to innovate products by adding productivity features to products like pry bars, hemostats, and tool boxes

2004

2005

2006

2007

2008

2009

2010

STUBBY FLEX RATCHETING WRENCH

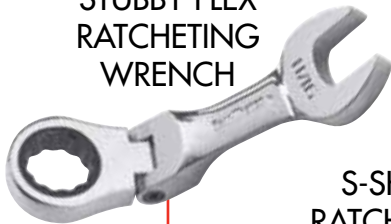

S-SHAPE RATCHETING WRENCH

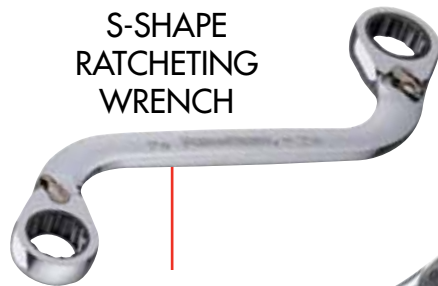

RATCHETING TAP & DIE



HALF MOON RATCHETING WRENCH



RATCHETING XL LOCKING FLEX WRENCHES



X-BEAM RATCHETING WRENCH



FULL POLISH RATCHETS

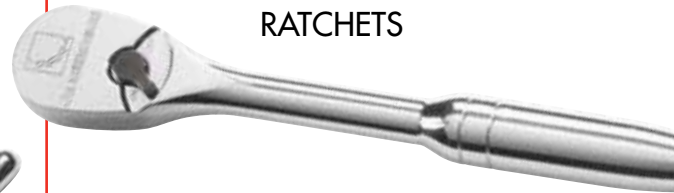

SCREWDRIVERS



STANDARD & DEEP SOCKETS



BIT & SPECIALTY SOCKETS



PLIERS



NEW PRODUCT HIGHLIGHTS

GearWrench has significantly expanded its product line of productivity solutions to help professional mechanics and technicians get their jobs done faster and easier. Look for these new items in this catalog, online at www.gearwrench.com and from your GearWrench distributor.

TOOL STORAGE SOLUTIONS p. 27

- 7 New XL series roller cabinets, top chests, and tool carts
- 24 New ball bearing series roller cabinets and top chests
- 4 New tool bags and tool storage accessories



IMPACT SOCKETS AND SOCKET SETS p. 159

- 28 New impact socket sets
- 70 New 1/4" Drive open stock sockets in SAE/METRIC, Standard/Deep/Universal
- 82 New 3/8" Drive open stock sockets in SAE/METRIC, Standard/Deep/Universal
- 138 New 1/2" Drive open stock sockets in SAE/METRIC, Standard/Deep/Universal
- 70 New 3/4" Drive open stock sockets in SAE/METRIC, Standard/Deep/Universal



EXPANDED LINE OF CHROME TOOLS

- 20 New Ratchet & Socket sets in 1/4", 3/8", and 1/2" Drive sizes
- 29 New 3/4" Drive Ratchets, Drive Tools, and Sockets from 7/8" through 2-3/8"

p. 37

- 40 New Combination Wrenches in both 6 Pt. and 12 Pt.
- 12 New Double-box End Wrenches
- 15 New Double Open-End Wrenches
- 19 New Adjustable Wrenches from 1/4" through 1-1/4" and 10mm through 19mm

p. 193

- 27 New solid handle Screwdrivers
- 34 New hollow shaft and insulated Nutdrivers

p. 271





- Automotive Repair
- Fleet Maintenance
- Diesel & Heavy Duty



INDUSTRY SOLUTIONS: *AUTOMOTIVE*

Simply put "time is money," and when technicians can get the job done faster than the industry standard, that's more money in their pockets. We are passionate about producing tools that focus on productivity, and doing more with less. That's why our innovative tools have been trusted by more professional technicians to "GET IT DONE."



INDUSTRY SOLUTIONS: *INDUSTRIAL & COMMERCIAL*

In today's industrial environment, mechanics rely on their tools to keep critical equipment operating with as little down time as possible. With manufacturing plants in 3 countries including the United States, GearWrench understands how critical it is to have the highest quality standards for manufacturing and the importance of dependable tools for the industry.

With nearly three thousand individual SKU's, GearWrench has one of the broadest and most complete professional hand tool lines in the market. We offer tools ranging from the precise to the nearly indestructible. No matter the industry you find yourself in, GearWrench has the tools to fit your needs.

- Industrial Maintenance & Repair Organizations
- Aviation
- Alternative Energy
- Commercial Construction



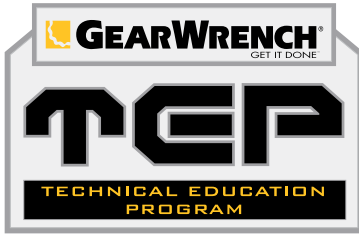

- Fully Featured Innovative Products
- Discounted Tool Sets and Tool Storage
- Free Tools for Students and Schools
- Free Hats, T-Shirts, Posters, etc.

INDUSTRY SOLUTIONS: *TECH ED PROGRAM*

Starting a new career can be one of the most nerve racking experiences in a person's life. For a mechanic or a technician, starting out can be especially tough when making that initial investment in the tools necessary to make a living in the future. GearWrench and our Technical Educational Program (TEP) can help ease that anxiety. We work with the leading instructors, institutions, and OEM manufacturers to ensure that when a student purchases a GearWrench TEP kit from an authorized distributor, they have the right tools for the job from day one, all without putting the student into severe debt. The bottom line is GearWrench provides students with fully featured products at a significant value.

- Auto Body
- Diesel
- HVAC
- Hybrids
- Electrical
- Wind Energy



MERCHANDISE

Image is everything, and at GearWrench. we don't disappoint. We offer a full assortment of hats, t-shirts, jackets, decals, polos, key chains, and much more. Visit our store at www.gearwrenchmerchandise.com for the latest updates and to view and purchase our complete selection.





Check out the many motosports and racing events we participate in by visiting www.gearwrench.com for event dates.



GEARWRENCH MOTORSPORTS

Put your money where your mouth is. That's quite a motto, but it symbolizes exactly how GearWrench has approached professional motorsports. NASCAR®, Sports Car Clubs of America (SCCA), and amateur drag, drifting, and motorcross are all part of GearWrench's motorsports program.

We view professional motorsports as much more than a car going fast around a track with our logo on the side. We partner with the drivers and just as importantly, the pit crews who use our tools to keep their cars in top shape and at top speed. This partnership allows some of the industry's most discerning tool users to push GearWrench tools to the limits and help us improve the tools for you. We get valuable tool ideas from racers daily and that's one of the many ways we come up with so many new innovative tool ideas.



Visit our website www.gearwrench.com for the latest news, product reviews, and information on what we're up to. One of the best ways to stay informed is to sign up for our newsletter. Its fast, easy, and private - and a great way to stay in the know on what we're doing.

- Find GearWrench distributors in "Where to Buy" section
- Get product dimensions and specifications
- Get images and other product details
- See product demonstration videos

TECHNICAL EDUCATION SETS



Technical Education Sets

Introductory Sets
Career Builder Sets
Intermediate and Advanced Tool Sets

GearWrench's Technical Education Program features carefully designed sets to fully equip the Student Technician with the tools necessary to conquer the service and repair challenges in today's Automotive, Heavy Duty/Diesel, Machinery, and Aviation fields.

Each tool set features innovations in speed, access, and design; hallmarks that have established the GearWrench® brand as a leader in quality, professional hand tools.

Each Technical Education Set also includes storage for sockets, wrenches, screwdrivers, and other tools to help promote efficient tool organization.

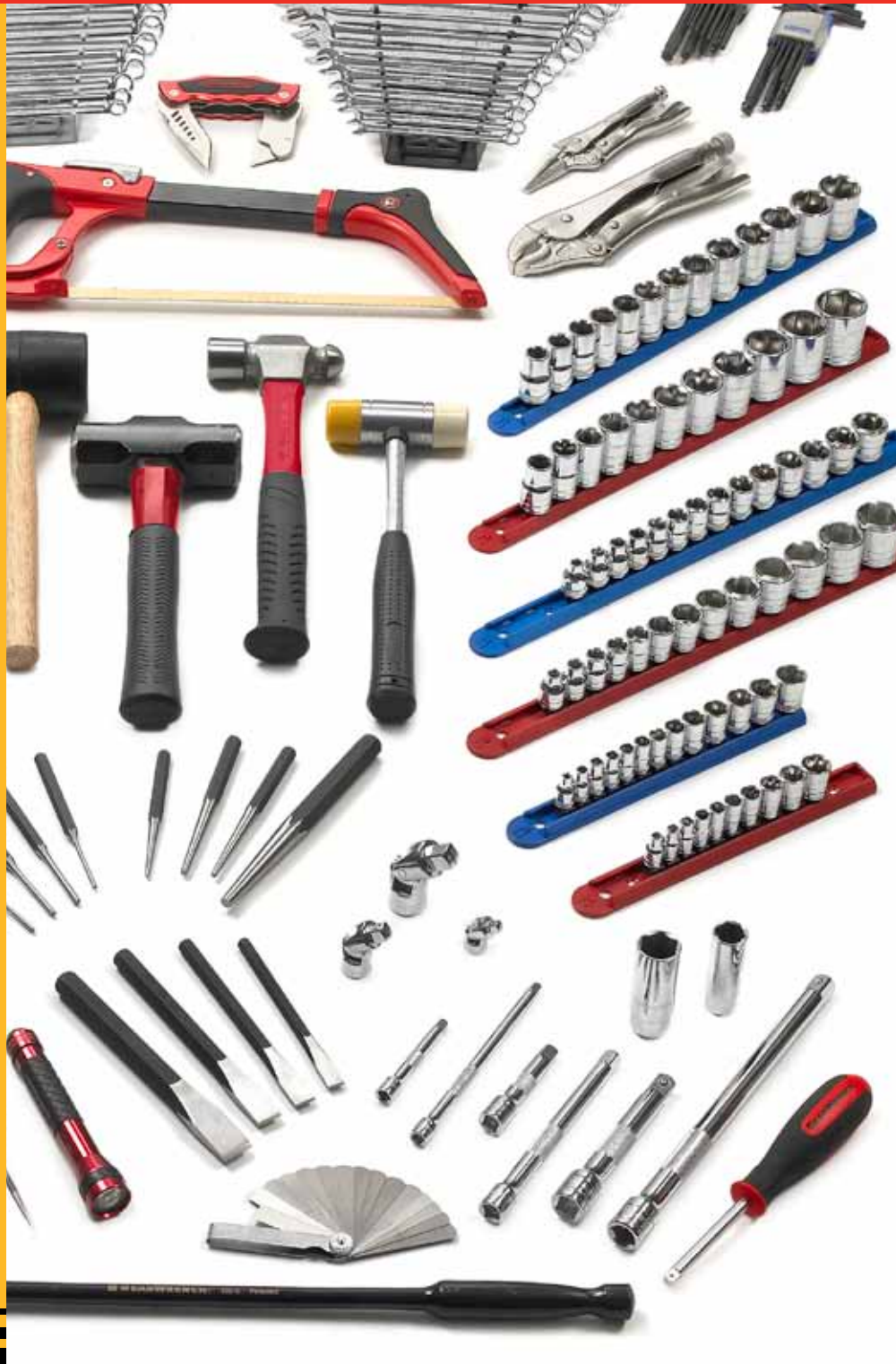

GearWrench® understands the environment you work in because we work side-by-side with technicians to learn about frustrations firsthand, and develop innovative, new hand tools to solve day-to-day problems. We know you will make a living with your tools and you need just the right tools to help you work smarter and faster. Across various tool categories, we deliver superior products that do just that. Our commitment to delivering the most durable and reliable products while adding time-saving features makes this possible.

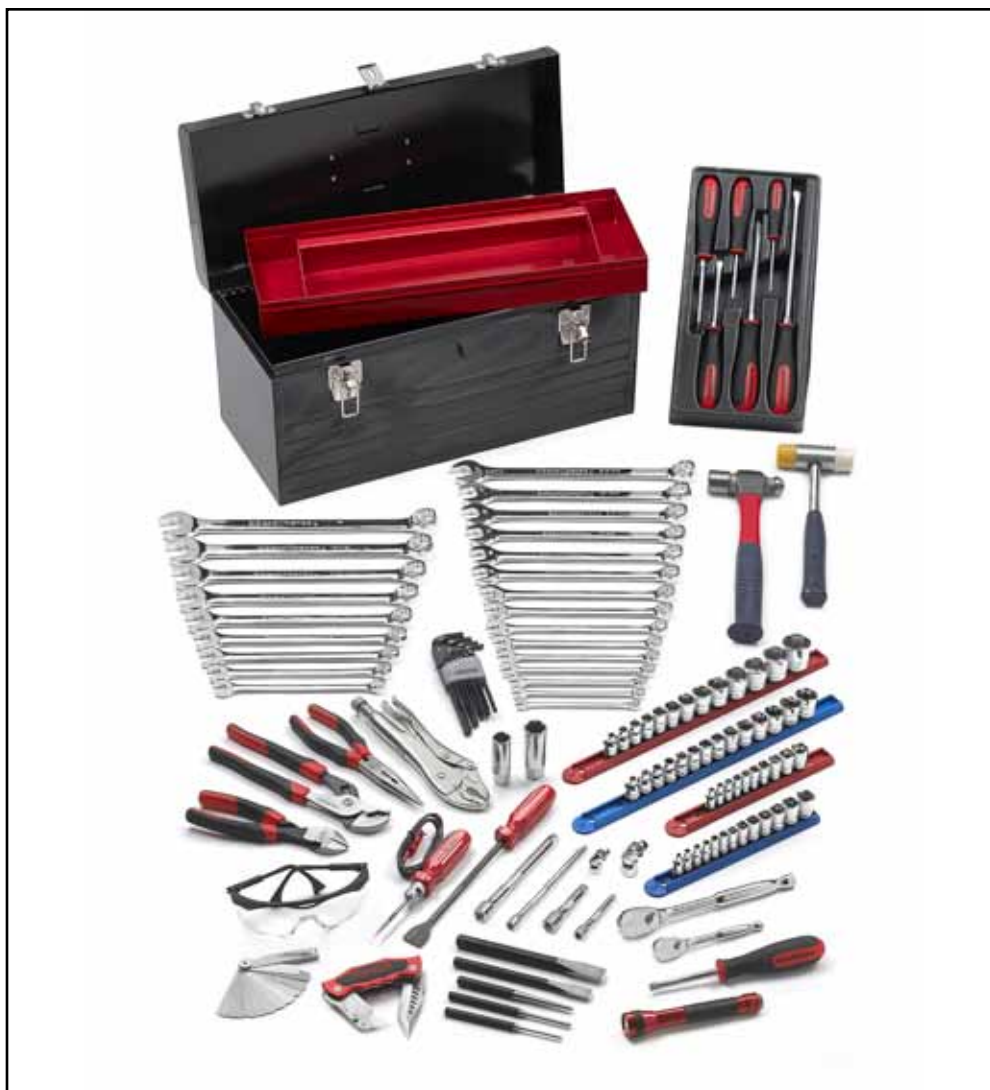

**83090 -
Auto Introductory
Set SAE/METRIC**

81658	5/8"	81670	13mm
81659	11/16"	81671	14mm
81660	3/4"	81672	15mm
81661	13/16"	81673	16mm
81662	7/8"	81674	17mm
81663	15/16"	81675	18mm
81664	1"	81676	19mm
81665	8mm	81677	20mm
81666	9mm	81678	21mm
81667	10mm	81679	22mm

Screwdrivers and Pliers

80050	6 Pc. Combination Screwdriver Set
80015	1/8" x 3" Slotted w/Cabinet Tip
80013	1/4" x 4" Slotted w/Hex Bolster
80023	5/16" x 6" Slotted w/Hex Bolster
80022	3/8" x 8" Slotted w/Hex Bolster
80001	#1 x 3" Phillips
80007	#2 x 4" Phillips w/Hex Bolster

82104 3 Pc. Mixed Pliers Set

82011	9.5" Tongue and Groove
82012	7" Diagonal Cutting
82013	8" Long Nose

Hex Keys

56603G 13 Pc. SAE ALLEN® Hex Key Set
 Sizes: 0.050", 1/16", 5/64", 3/32", 7/64",
 1/8", 9/64", 5/32", 3/16", 7/32", 1/4",
 5/16", 3/8"

Punches and Chisels

82304	5 Pc. Punch and Chisel Set
82270	3/8" x 5" Center Punch
82273	1/8" x 5" x 5/16" Pin Punch
82274	5/32" x 5-1/4" x 5/16" Pin Punch
82275	3/16" x 5-1/2" x 5/16" Pin Punch
82264	1/2" x 6" x 3/8" Cold Chisel

General Purpose Tools

82251	16 oz. Ball Pein Hammer - Fiberglass
82260	12 oz. Softface Hammer Removable Caps
82881	Folding Utility Knife
83132	Aluminum Flashlight
82041	10" Curved Jaw Locking Pliers
69-990	Safety Glasses

KD® Specialty Tools

KDS129	Low Voltage Circuit Tester
KDS162	16 Blade Feeler Gauge
KDS485	Gasket Scraper

Tool Storage

83130	Tote Box
-------	----------

Not all tools GearWrench® Branded

1/4" Drive Sockets

80302	13 Pc. 6 Pt. Metric Socket Set		
80125	4mm	80132	10mm
80126	5mm	80133	11mm
80127	5.5mm	80134	12mm
80128	6mm	80135	13mm
80129	7mm	80136	14mm
80130	8mm	80137	15mm
80131	9mm		
80303	10 Pc. 6 Pt. SAE Socket Set		
80105	3/16"	80110	11/32"
80106	7/32"	80111	3/8"
80107	1/4"	80112	7/16"
80108	9/32"	80113	1/2"
80109	5/16"	80114	9/16"

1/4" Drive Tools

81011	Full Polish Ratchet
81113	3" Extension
81116	6" Extension
81128	Spinner Handle

3/8" Drive Sockets

80552	14 Pc. 6 Pt. Metric Socket Set		
80374	6mm	80381	13mm
80375	7mm	80382	14mm
80376	8mm	80383	15mm
80377	9mm	80384	16mm
80378	10mm	80385	17mm
80379	11mm	80386	18mm
80380	12mm	80387	19mm

80553 13 Pc. 6 Pt. SAE Socket Set

80350	1/4"	80357	11/16"
80351	5/16"	80358	3/4"

80352	3/8"	80359	13/16"
80353	7/16"	80360	7/8"
80354	1/2"	80361	15/16"
80355	9/16"	80362	1"
80356	5/8"		

3/8" Drive Tools

81211	Full Polish Teardrop Ratchet
81241	3" Extension
81242	6" Extension
80549	Universal Joint
80402	5/8" Spark Plug Socket
80403	13/16" Spark Plug Socket

Combination Wrenches

81900	24 Pc. SAE/Metric Long Pattern Combination Non-Ratcheting Wrench Set		
81656	1/2"	81668	11mm
81657	9/16"	81669	12mm

83091 - Career Builder Starter Set



SETS

TECHNICAL EDUCATION

1/4" Drive Sockets

80302 13 Pc. 6 Pt. Metric Socket Set

80125	4mm	80132	10mm
80126	5mm	80133	11mm
80127	5.5mm	80134	12mm
80128	6mm	80135	13mm
80129	7mm	80136	14mm
80130	8mm	80137	15mm
80131	9mm		

80303 10 Pc. 6 Pt. SAE Socket Set

80105	3/16"	80110	11/32"
80106	7/32"	80111	3/8"
80107	1/4"	80112	7/16"
80108	9/32"	80113	1/2"
80109	5/16"	80114	9/16"

80304 13 Pc. 6 Pt. Deep Metric Socket Set

80138	4mm	80145	10mm
80139	5mm	80146	11mm
80140	5.5mm	80147	12mm
80141	6mm	80148	13mm
80142	7mm	80149	14mm
80143	8mm	80150	15mm
80144	9mm		

80305 10 Pc. 6 Pt. Deep SAE Socket Set

80115	3/16"	80120	11/32"
80116	7/32"	80121	3/8"
80117	1/4"	80122	7/16"
80118	9/32"	80123	1/2"
80119	5/16"	80124	9/16"

3/8" Drive Sockets

80552 14 Pc. 6 Pt. Metric Socket Set

80374	6mm	80381	13mm
80375	7mm	80382	14mm
80376	8mm	80383	15mm
80377	9mm	80384	16mm
80378	10mm	80385	17mm
80379	11mm	80386	18mm
80380	12mm	80387	19mm

80553 13 Pc. 6 Pt. SAE Socket Set

80350	1/4"	80357	11/16"
80351	5/16"	80358	3/4"
80352	3/8"	80359	13/16"
80353	7/16"	80360	7/8"
80354	1/2"	80361	15/16"
80355	9/16"	80362	1"
80356	5/8"		

80554 14 Pc. 6 Pt. Deep Metric Socket Set

80388	6mm	80395	13mm
80389	7mm	80396	14mm
80390	8mm	80397	15mm
80391	9mm	80398	16mm
80392	10mm	80399	17mm

80393	11mm	80400	18mm
80394	12mm	80401	19mm

80555 11 Pc. 6 Pt. Deep SAE Socket Set

80363	1/4"	80369	5/8"
80364	5/16"	80370	11/16"
80365	3/8"	80371	3/4"
80366	7/16"	80372	13/16"
80367	1/2"	80373	7/8"
80368	9/16"		

1/2" Drive Sockets

80702 13 Pc. 6 Pt. Metric Socket Set

81624	12mm	81631	19mm
81625	13mm	81632	20mm
81626	14mm	81633	21mm
81627	15mm	81634	22mm
81628	16mm	81635	23mm
81629	17mm	81636	24mm
81630	18mm		

80703 11 Pc. 6 Pt. SAE Socket Set

80603	1/2"	80609	7/8"
80604	9/16"	80610	15/16"
80605	5/8"	80611	1"
80606	11/16"	80612	1-1/16"
80607	3/4"	80613	1-1/8"
80608	13/16"		

1/4", 3/8", 1/2" Drive Tools

81206 3 Pc. Full Polish Ratchet Set 1/4", 3/8", & 1/2" Drive

81113	3" Extension 1/4" Drive
81116	6" Extension 1/4" Drive
80100	Universal Joint 1/4" Drive
81128	Spinner Handle 1/4" Drive
81241	3" Extension 3/8" Drive
81242	6" Extension 3/8" Drive
80549	Universal Joint 3/8" Drive
80402	5/8" Spark Plug Socket 3/8" Drive
80403	13/16" Spark Plug Socket 3/8" Drive
80600	Universal Joint 1/2" Drive
81341	5" Extension 1/2" Drive
81342	10" Extension 1/2" Drive

Combination Wrenches

81901 15 Pc. SAE Long Pattern Non-Ratcheting Wrench Set

81650	1/4"	81658	5/8"
81651	9/32"	81659	11/16"
81652	5/16"	81660	3/4"
81653	11/32"	81661	13/16"
81654	3/8"	81662	7/8"
81655	7/16"	81663	15/16"
81656	1/2"	81664	1"
81657	9/16"		

81902 15 Pc. Metric Long Pattern Non-Ratcheting Wrench Set

81665	8mm	81673	16mm
81666	9mm	81674	17mm
81667	10mm	81675	18mm
81668	11mm	81676	19mm
81669	12mm	81677	20mm
81670	13mm	81678	21mm
81671	14mm	81679	22mm
81672	15mm		

Screwdrivers and Pliers

80051 12 Pc. Combination Screwdriver Set

80012	1/4" x 1-1/2" Slotted
80018	3/16" x 6" Slotted w/ Cabinet Tip
80013	1/4" x 4" Slotted w/Hex Bolster
80014	1/4" x 6" Slotted w/Hex Bolster
80023	5/16" x 6" Slotted w/Hex Bolster
80022	3/8" x 8" Slotted w/Hex Bolster
80000	#0 x 2-1/2" Phillips
80001	#1 x 3" Phillips
80004	#1 x 6" Phillips
80005	#2 x 1-1/2" Phillips
80007	#2 x 4" Phillips w/Hex Bolster
80011	#3 x 6" Phillips w/Hex Bolster

82103 4 Pc. Mixed Pliers Set

82011	9.5" Tongue and Groove
82012	7" Diagonal Cutting
82013	8" Long Nose
82014	8" Slip Joint

Hex Keys

56612G 13Pc. SAE ALLEN® Ball End Hex Key Set

Sizes: 0.050", 1/16", 5/64", 3/32", 7/64", 1/8", 9/64", 5/32", 3/16", 7/32", 1/4", 5/16", 3/8"

56615G 9Pc. Metric ALLEN® Ball End Hex Key Set

Sizes: 1.5, 2, 2.5, 3, 4, 5, 6, 8, 10mm

Files, Punches & Chisels

82820 4 Pc. STD File Set

82822	8" Flat
82823	8" Round
82824	8" Half Round
82825	8" Triangle

82305 12 Pc. Punch and Chisel Set

82261	1/4" x 4-3/4" x 1/4" Cold Chisel
82262	3/8" x 5" x 5/16" Cold Chisel
82264	1/2" x 6" x 3/8" Cold Chisel
82265	5/8" x 6-1/2" x 3/8" Cold Chisel
82270	3/8" x 5" Center Punch
82272	3/32" x 4-3/4" x 5/16" Pin Punch
82273	1/8" x 5" x 5/16" Pin Punch

82274	5/32" x 5-1/4" x 5/16" Pin Punch
82275	3/16" x 5-1/2" x 5/16" Pin Punch
82278	1/8" x 8" x 3/8" Long Taper Punch
82283	3/16" x 5" x 3/8" Starter Punch
82285	1/8" x 4-1/2" x 5/16" Starter

General Purpose Tools

82216	16" Indexing Pry Bar
82880	High Tension Hacksaw
82251	16 oz. Ball Pein Hammer - Fiberglass
82260	12 oz. Sofface Hammer Removable Caps
82255	3 lb. Drilling Hammer
82259	16 oz. Rubber Mallet-Wood Hickory Handle
82881	Folding Utility Knife
83131	16' Tape Measure SAE/Metric
83132	Aluminum Flashlight
82041	10" Curved Jaw Locking Pliers
82043	6" Long Nose Locking Pliers
69-990	Safety Glasses

KD® Specialty Tools

KDS129	Low Voltage Circuit Tester
KDS162	16 Blade Feeler Gauge
KDS485	Gasket Scraper
KDS2109	Telescoping Mirror
KDS2281	Telescoping Magnetic Retrieving Tool

Not all tools GearWrench® Branded

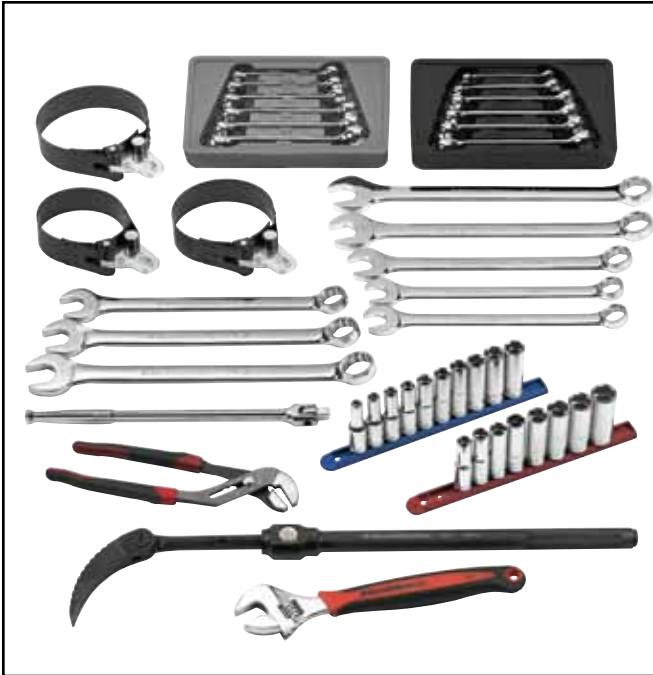

1/2" Drive Sockets

80704	10 Pc. 6 Pt. Deep Metric Socket	80640	13mm	80645	18mm
80637	10mm	80642	15mm	80641	14mm
80638	11mm	80643	16mm	80646	19mm
80629	17mm	80644	17mm	80705	8 Pc. 6 Pt. Deep SAE Socket Set
		80614	1/2"	80618	3/4"
		80615	9/16"	80619	13/16"

83092 - Career Builder Diesel Add-on TEP Set

80616	5/8"	80620	7/8"
80617	11/16"	80621	15/16"

1/2" Drive Tools

81307	Full Polish Flex Handle
-------	-------------------------

Combination Wrenches

SAE Combination Wrenches

81733	1-1/6"
81734	1-1/8"
81735	1-1/4"

Metric Combination Wrenches

81741	23mm	81744	30mm
81742	24mm	81745	32mm
81743	27mm		

Flare Nut Wrenches

81906	6 Pc. Metric Flare Nut Wrench Set
81644	9 x 11mm
81645	10 x 12mm
81646	13 x 14mm
81647	15 x 17mm
81648	16 x 18mm
81649	19 x 21mm

81907	6 Pc. SAE Flare Nut Wrench Set
81680	1/4" x 5/16"
81681	3/8 x 7/16"
81682	1/2" x 9/16"
81683	5/8" x 11/16"
81684	5/8" x 3/4"
81685	3/4" x 7/8"

General Purpose Tools

82220	18" to 29" Extendable Pry Bar
82020	12" Groove Joint Pliers-Straight Jaw
81893	12" Adjustable Cushion Grip Wrench

KD® Specialty Tools

KDS2320	Heavy Duty Oil Filter Wrench (4-1/8" to 4-21/32")
KDS2321	Heavy Duty Oil Filter Wrench (4-21/32" to 5-5/32")
KDS2322	Heavy Duty Oil Filter Wrench (5-5/32" to 5-21/32")

Not all tools GearWrench® Branded



83093 - Career Builder Auto Body Add-on TEP Set

General Body Tools

84050	4 Pc. Door Pad and Panel Removal Kit
84051	4" V-Notch Puller
84052	4" Square Notch Puller
84053	4" Scraper
84054	4" Curved Blade V-Notch Puller
84000	7 Pc. Hook And Pick Set
84001	5" Cotter Pin Puller
84002	4" Hose Pick Puller
84003	4-1/2" Awl
84004	3-1/8 Mini Full Hook
84005	3-1/8 90° Mini Hook
84006	3-1/8 Straight Mini Hook
84007	3-1/8 Mini Offset Hook
82302	7 Pc. Body Hammer Set

Torx® Bit Sockets

80723	13 Pc. Torx® Press Fit Bit Socket Set
80171	1 T-8, 1/4" Drive
80172	T-10, 1/4" Drive

80173	T-15, 1/4" Drive
80174	T-20, 1/4" Drive
80175	T-25, 1/4" Drive
80176	T-27, 1/4" Drive
80177	T-30, 1/4" Drive
80451	T-40, 3/8" Drive
80452	T-45, 3/8" Drive
80453	T-47, 3/8" Drive
80454	T-50, 3/8" Drive
80455	T-55, 3/8" Drive
80667	T-60, 1/2" Drive

KD® Specialty Tools

KDS038	Window Molding Removal Tool
KDS431	Door Handle Window Lift Remover
KDS2822	Trim Pad Removal Tool
KDS3729	Push Pin Puller
KDS2106	All Purpose Sticker Scraper Tool
KDS2311	Shoe Handle Wire Scratch Brush
KDS2426	3" Putty Knife/Scraper
KDS2425	1-1/4" Putty Knife/Scraper

83094 - Career Builder HVAC Add-on TEP Set

Wrenches

- 81910 5 Pc. SAE Flex Flare Nut Wrench Set
- 81693 1/4" x 5/16"
- 81694 3/8 x 7/16"
- 81695 1/2" x 9/16"
- 81696 5/8" x 11/16"
- 81697 3/4" x 7/8"
- 81911 6 Pc. Metric Flex Flare Nut Wrench Set
- 81686 9 x 11mm
- 81687 10 x 12mm
- 81688 13 x 14mm
- 81689 15 x 17mm
- 81690 16 x 18mm
- 81692 19 x 21mm
- 81990 3 Pc. Adjustable Wrench Set
- 81890 6"
- 81891 8"
- 81892 10"
- 85220 QuadBox™ HVAC Ratcheting Wrench
Sizes: 1/4" x 3/16" square, 3/8" x 5/16" square
- 85221 QuadBox™ HVAC Ratcheting Wrench
Sizes: 1/4" x 3/16" square, 9/16" x 1/2" hex

Cutting Tools

- 82841 Right Cutting Aviation Snips
- 82842 Left Cutting Aviation Snips
- 82843 3 Pc. Aviation Snip Set

General HVAC Tools

- 9-39829 Torpedo Level
- 69-350 10oz. Claw Hammer
- 73-014 14" Pipe Wrench
- MC33661 Manifold Set
- 66-843 7 Pc. SAE Nut Driver Set
(1/4" x 9/32", 5/16", 11/32", 3/8", 7/16", 1/2")

KD® Specialty Tools

- 41590 Tubing Service Set
- 2107 Mini Tubing Cutter
- 2189 Tubing Bender
- 3905 Deburring Tool
- 41594 Flaring Adapter Kit
- 41595 Holding Bar
- 41596 Yoke
- 3457 Large Tubing Cutter



83095 - Intermediate Auto TEP Set



1/4" Drive Sockets

80302 13 Pc. Metric 6 Pt. Socket Set

80125	4mm	80132	10mm
80126	5mm	80133	11mm
80127	5.5mm	80134	12mm
80128	6mm	80135	13mm
80129	7mm	80136	14mm
80130	8mm	80137	15mm
80131	9mm		

80302 13 Pc. 6 Pt. Metric Socket Set

80105	3/16"	80110	11/32"
80106	7/32"	80111	3/8"
80107	1/4"	80112	7/16"
80108	9/32"	80113	1/2"
80109	5/16"	80114	9/16"

80304 13 Pc. 6 Pt. Deep Metric Socket Set

80138	4mm	80145	10mm
80139	5mm	80146	11mm
80140	5.5mm	80147	12mm
80141	6mm	80148	13mm
80142	7mm	80149	14mm
80143	8mm	80150	15mm
80144	9mm		

80305 10 Pc. 6 Pt. Deep SAE Socket Set

80115	3/16"	80120	11/32"
80116	7/32"	80121	3/8"
80117	1/4"	80122	7/16"
80118	9/32"	80123	1/2"
80119	5/16"	80124	9/16"

3/8" Drive Sockets

80552 14 Pc. 6 Pt. Metric Socket Set

80374	6mm	80381	13mm
80375	7mm	80382	14mm
80376	8mm	80383	15mm
80377	9mm	80384	16mm
80378	10mm	80385	17mm
80379	11mm	80386	18mm
80380	12mm	80387	19mm

80553 13 Pc. 6 Pt. SAE Socket Set

80350	1/4"	80357	11/16"
80351	5/16"	80358	3/4"
80352	3/8"	80359	13/16"
80353	7/16"	80360	7/8"
80354	1/2"	80361	15/16"
80355	9/16"	80362	1"
80356	5/8"		

80554 14 Pc. 6 Pt. Deep Metric Socket Set

80388	6mm	80395	13mm
80389	7mm	80396	14mm
80390	8mm	80397	15mm
80391	9mm	80398	16mm

80392	10mm	80399	17mm
80393	11mm	80400	18mm
80394	12mm	80401	19mm

80555 11 Pc. 6 Pt. Deep SAE Socket Set

80363	1/4"	80369	9/16"
80364	5/16"	80370	5/8"
80365	3/8"	80371	11/16" 6
80366	1/4"	80372	3/4"
80367	7/16"	80373	7/8"
80368	1/2"		

1/2" Drive Sockets

80702 13 Pc. 6 Pt. Metric Socket Set

81624	12mm	81631	19mm
81625	13mm	81632	20mm
81626	14mm	81633	21mm
81627	15mm	81634	22mm
81628	16mm	81635	23mm
81629	17mm	81636	24mm
81630	18mm		

80703 11 Pc. 6 Pt. SAE Socket Set

80603	1/2"	80609	7/8"
80604	9/16"	80610	15/16"
80605	5/8"	80611	1"
80606	11/16"	80612	1-1/16"
80607	3/4"	80613	1-1/8"
80608	13/16"		

1/4", 3/8", 1/2" Drive Sockets

81206 3 Pc. Full Polish Ratchet Set (1/4", 3/8", 1/2" Drive)

81113	3" Extension 1/4" Drive
80100	Universal Joint 1/4" Drive
81128	Spinner Handle 1/4" Drive
81241	3" Extension 3/8" Drive
81242	6" Extension 3/8" Drive
80549	Universal Joint 3/8" Drive
80402	5/16" Spark Plug Socket 3/8" Drive
80403	13/16" Spark Plug Socket 3/8" Drive
80600	Universal Joint 1/2" Drive
81341	5" Extension 1/2" Drive
81307	Full Polish Flex Handle 1/2" Drive

Combination Wrenches

81901 15 Pc. SAE Long Pattern Combination Non-Ratcheting Wrench Set

81650	1/4"	81658	5/8"
81651	9/32"	81659	11/16"
81652	5/16"	81660	3/4"
81653	11/32"	81661	13/16"
81654	3/8"	81662	7/8"
81655	7/16"	81663	15/16"
81656	1/2"	81664	1"
81657	9/16"		

81902 15 Pc. Metric Long Pattern Combination Non-Ratcheting Wrench Set

81665	8mm	81673	16mm
81666	9mm	81674	17mm
81667	10mm	81675	18mm
81668	11mm	81676	19mm
81669	12mm	81677	20mm
81670	13mm	81678	21mm
81671	14mm	81679	22mm
81672	15mm		

Screwdrivers and Pliers

80051 12 Pc. Combination Screwdriver Set

80012	1/4" x 1-1/2" Slotted
80018	3/16" x 6" Slotted w/Cabinet Tip
80013	1/4" x 4" Slotted w/Hex Bolster
80014	1/4" x 6" Slotted w/Hex Bolster
80023	5/16" x 6" Slotted w/Hex Bolster
80022	3/8" x 8" Slotted w/Hex Bolster
80000	#0 x 2-1/2" Phillips
80001	#1 x 3" Phillips
80004	#1 x 6" Phillips
80005	#2 x 1-1/2" Phillips
80007	#2 x 4" Phillips w/Hex Bolster
80011	#3 x 6" Phillips w/Hex Bolster

82108 7 Pc. Mixed Pliers Set

82011	Tongue and Groove
82012	Diagonal Cutting
82013	Long Nose
82014	Slip Joint
82020	12" Groove Joint with Straight Jaw
82025	8" Linesman
82028	8" End Nipper
82005	Straight Double-X™ Pliers

Hex Keys

56603G 13 Pc. SAE ALLEN® Hex Key Set
 Sizes: 0.050", 1/16", 5/64", 3/32", 7/64", 1/8", 9/64", 5/32", 3/16", 7/32", 1/4", 5/16", 3/8"

56615G 9 Pc. Metric ALLEN® Ball End Hex Key Set
 Sizes: 1.5, 2, 2.5, 3, 4, 5, 6, 8, 10mm

Punch & Chisels

82305 12 Pc. Punch and Chisel Set

82261	1/4" x 4-3/4" x 1/4" Cold Chisel
82262	3/8" x 5" x 5/16" Cold Chisel
82264	1/2" x 6" x 3/8" Cold Chisel
82265	5/8" x 6-1/2" x 3/8" Cold Chisel
82270	3/8" x 5" Center Punch
82272	3/32" x 4-3/4" x 5/16" Pin Punch
82273	1/8" x 5" x 5/16" Pin Punch
82274	5/32" x 5-1/4" x 5/16" Pin Punch

82275	3/16" x 5-1/2" x 5/16" Pin Punch
82278	1/8" x 8" x 3/8" Long Taper Punch
82283	3/16" x 5" x 3/8" Starter Punch
82285	1/8" x 4-1/2" x 5/16" Starter

Torx® Bit Sockets

80723 13 Pc. Torx® Press Fit Bit Socket Set 1/4", 3/8", 1/2" Drive

80171	T-8, 1/4" Drive
80172	T-10, 1/4" Drive
80173	T-15, 1/4" Drive
80174	T-20, 1/4" Drive
80175	T-25, 1/4" Drive
80176	T-27, 1/4" Drive
80177	T-30, 1/4" Drive
80451	T-40, 3/8" Drive
80452	T-45, 3/8" Drive
80453	T-47, 3/8" Drive
80454	T-50, 3/8" Drive
80455	T-55, 3/8" Drive
80667	T-60, 1/2" Drive

General Purpose Tools

82880	High Tension Hacksaw
82251	16 oz Ball Pein Hammer - Fiberglass
82260	12 oz Softface Hammer Removable Caps
82255	3 lb Drilling Hammer
82259	16 oz Rubber Mallet - Wood Hickory
82881	Folding Utility Knife
83131	Intermediate Aviation Set
83132	Intermediate Aviation Set

82102 3 Pc. Locking Pliers Set

82043	Long Nose Locking Pliers 6"
990	Curved Jaw Locking Pliers 5"
990	Curved Jaw Locking Pliers 10"
69-990	Safety Glasses

KD® Specialty Tools

KDS129	Low Voltage Circuit Tester
KDS162	16 Blade Feeler Gauge
KDS485	Gasket Scraper
KDS2282	Slotted Screw Starter
KDS2283	Phillips Screw Starter
KDS2774	Brake Retaining Spring Tool
KDS298	Brake Spring Pliers
KDS295	Brake Shoe Adjusting Tool
KDS3163	Rear Brake Piston Tool
KDS2840	Telescoping Mirror
KDS2593	Telescoping Magnetic Pick-Up Tool
KDS3151	Interchangeable Snap Ring Pliers
KDS2162	Wire Stripper Crimper

Not all tools GearWrench® Branded



83097 - Intermediate Auto Body TEP Set

80392	10mm	80399	17mm
80393	11mm	80400	18mm
80394	12mm	80401	19mm
80555 11 Pc. 6 Pt. Deep SAE Socket Set			
80363	1/4"	80369	9/16"
80364	5/16"	80370	5/8"
80365	3/8"	80371	11/16"
80366	1/4"	80372	3/4"
80367	7/16"	80373	7/8"
80368	1/2"		

1/2" Drive Sockets

80702 13 Pc. 6 Pt. Metric Socket Set			
81624	12mm	81631	19mm
81625	13mm	81632	20mm
81626	14mm	81633	21mm
81627	15mm	81634	22mm
81628	16mm	81635	23mm
81629	17mm	81636	24mm
81630	18mm		

80703 11 Pc. 6 Pt. SAE Socket Set

80603	1/2"	80609	7/8"
80604	9/16"	80610	15/16"
80605	5/8"	80611	1"
80606	11/16"	80612	1-1/16"
80607	3/4"	80613	1-1/8"
80608	13/16"		

1/4", 3/8", 1/2" Drive Sockets

81206 3 Pc. Full Polish Ratchet Set (1/4", 3/8", 1/2" Drive)			
81113	3" Extension	1/4" Drive	
80100	Universal Joint	1/4" Drive	
81128	Spinner Handle	1/4" Drive	
81241	3" Extension	3/8" Drive	
81242	6" Extension	3/8" Drive	
80549	Universal Joint	3/8" Drive	
80402	Intermediate Auto Body Set		
80403	13/16" Spark Plug Socket	3/8" Dr.	
80600	Universal Joint	1/2" Drive	
81341	5" Extension	1/2" Drive	
81307	Full Polish Flex Handle	1/2" Drive	

81901 15 Pc. SAE Long Pattern Combination Non-Ratcheting Wrench Set

81650	1/4"	81658	5/8"
81651	9/32"	81659	11/16"
81652	5/16"	81660	3/4"
81653	11/32"	81661	13/16"
81654	3/8"	81662	7/8"
81655	7/16"	81663	15/16"

1/4" Drive Sockets

80302 13 Pc. 6 Pt. Metric Socket Set			
80125	4mm	80132	10mm
80126	5mm	80133	11mm
80127	5.5mm	80134	12mm
80128	6mm	80135	13mm
80129	7mm	80136	14mm
80130	8mm	80137	15mm
80131	9mm		
80303 10 Pc. 6 Pt. SAE Socket Set			
80105	3/16"	80110	11/32"
80106	7/32"	80111	3/8"
80107	1/4"	80112	7/16"
80108	9/32"	80113	1/2"
80109	5/16"	80114	9/16"
80304 13 Pc. 6 Pt. Deep Metric Socket Set			
80138	4mm	80145	10mm

80139	5mm	80146	11mm
80140	5.5mm	80147	12mm
80141	6mm	80148	13mm
80142	7mm	80149	14mm
80143	8mm	80150	15mm
80144	9mm		

80305 10 Pc. 6 Pt. Deep SAE Socket Set			
80115	3/16"	80120	11/32"
80116	7/32"	80121	3/8"
80117	1/4"	80122	7/16"
80118	9/32"	80123	1/2"
80119	5/16"	80124	9/16"

3/8" Drive Sockets

80552 14 Pc. 6 Pt. Metric Socket Set			
80374	6mm	80381	13mm
80375	7mm	80382	14mm
80376	8mm	80383	15mm

80377	9mm	80384	16mm
80378	10mm	80385	17mm
80379	11mm	80386	18mm
80380	12mm	80387	19mm
80553 13 Pc. 6 Pt. SAE Socket Set			
80350	1/4"	80357	11/16"
80351	5/16"	80358	3/4"
80352	3/8"	80359	13/16"
80353	7/16"	80360	7/8"
80354	1/2"	80361	15/16"
80355	9/16"	80362	1"
80356	5/8"		

80554 14 Pc. 6 Pt. Deep Metric Socket Set			
80388	6mm	80395	13mm
80389	7mm	80396	14mm
80390	8mm	80397	15mm
80391	9mm	80398	16mm

81656	1/2"	81664	1"
81657	9/16"		
81902	15 Pc. Metric Long Pattern Combination Non-Ratcheting Wrench Set		
81665	8mm	81673	16mm
81666	9mm	81674	17mm
81667	10mm	81675	18mm
81668	11mm	81676	19mm
81669	12mm	81677	20mm
81670	13mm	81678	21mm
81671	14mm	81679	22mm
81672	15mm		

Screwdrivers and Pliers

80051	12 Pc. Combination Screwdriver Set		
80012	1/4" x 1-1/2"	Slotted	
80018	3/16" x 6"	Slotted w/Cabinet Tip	
80013	1/4" x 4"	Slotted w/Hex Bolster	
80014	1/4" x 6"	Slotted w/Hex Bolster	
80023	5/16" x 6"	Slotted w/Hex Bolster	
80022	3/8" x 8"	Slotted w/Hex Bolster	
80000	#0 x 2-1/2"	Phillips	
80001	#1 x 3"	Phillips	
80004	#1 x 6"	Phillips	
80005	#2 x 1-1/2"	Phillips	
80007	#2 x 4"	Phillips w/Hex Bolster	
80011	#3 x 6"	Phillips w/Hex Bolster	
82103	4 Pc. Mixed Pliers Set		
82011	9.5"	Tongue and Groove	
82012	7"	Diagonal Cutting	
82013	8"	Long Nose	

Hex Keys

56603G 13 Pc. SAE ALLEN® Hex Key Set
 Sizes: 0.050", 1/16", 5/64", 3/32", 7/64", 1/8", 9/64", 5/32", 3/16", 7/32", 1/4", 5/16", 3/8"

Punch & Chisels

82305	12 Pc. Punch and Chisel Set		
82261	1/4" x 4-3/4" x 1/4"	Cold Chisel	
82262	3/8" x 5" x 5/16"	Cold Chisel	
82264	1/2" x 6" x 3/8"	Cold Chisel	
82265	5/8" x 6-1/2" x 3/8"	Cold Chisel	
82270	3/8" x 5"	Center Punch	
82272	3/32" x 4-3/4" x 5/16"	Pin Punch	
82273	1/8" x 5" x 5/16"	Pin Punch	
82274	5/32" x 5-1/4" x 5/16"	Pin Punch	
82275	3/16" x 5-1/2" x 5/16"	Pin Punch	
82278	1/8" x 8" x 3/8"	Long Taper Punch	
82283	3/16" x 5" x 3/8"	Starter Punch	
82285	1/8" x 4-1/2" x 5/16"	Long Taper Punch	

Hex and Torx® Bit Sockets

80726	36 Pc. Master Torx® Set with Hex Bit Sockets		
80172	T-10, 1/4"	Drive	
80173	T-15, 1/4"	Drive	
80174	T-20, 1/4"	Drive	
80175	T-25, 1/4"	Drive	
80176	T-27, 1/4"	Drive	
80177	T-30, 1/4"	Drive	
80187	E-5, 1/4"	Drive	
80188	E-6, 1/4"	Drive	
80189	E-7, 1/4"	Drive	
80190	E-8, 1/4"	Drive	
80451	T-40, 3/8"	Drive	
80452	T-45, 3/8"	Drive	
80453	T-47, 3/8"	Drive	
80454	T-50, 3/8"	Drive	
80455	T-55, 3/8"	Drive	
80416	5/32", 3/8"	Drive	
80417	3/16", 3/8"	Drive	
80418	7/32", 3/8"	Drive	
80419	1/4", 3/8"	Drive	
80420	5/16", 3/8"	Drive	
80421	3/8", 3/8"	Drive	
80422	2mm, 3/8"	Drive	
80423	2.5mm, 3/8"	Drive	
80424	3mm, 3/8"	Drive	
80425	4mm, 3/8"	Drive	
80426	5mm, 3/8"	Drive	
80427	6mm, 3/8"	Drive	
80428	7mm, 3/8"	Drive	
80429	8mm, 3/8"	Drive	
80430	9mm, 3/8"	Drive	
80431	10mm, 3/8"	Drive	
80460	E-10, 3/8"	Drive	
80461	E-12, 3/8"	Drive	
80462	E-14, 3/8"	Drive	
80463	E-16, 3/8"	Drive	
80669	E-18, 1/2"	Drive	

General Body Tools

84050	4 Pc. Door Pad and Panel Removal Kit		
84051	4"	V-Notch Puller	
84052	4"	Square Notch Puller	
84053	4"	Scraper	
84054	4"	Curved Blade V-Notch Puller	
84000	7 Pc. Hook And Pick Set		
84001	5"	Cotter Pin Puller	
84002	4"	Hose Pick Puller	
84003	4-1/2"	Awl	
84004	3-1/8	Mini Full Hook	
84005	3-1/8	90° Mini Hook	
84006	3-1/8	Straight Mini Hook	

84007	3-1/8	Mini Offset Hook	
82820	4 Pc. STD FileS Set		
82822	8"	Flat	
82823	8"	Round	
82824	8"	Half Round	
82825	8"	Triangle	
82302	7 Pc. Body Hammer Set		

General Body Tools

82880	High Tension	Hacksaw	
82840	Straight Cutting	Aviation Snips	
82251	16 oz	Ball Pein Hammer - Fiberglass	
82260	12 oz	Softface Hammer Removable Caps	
82255	3 lb	Drilling Hammer	
82259	16 oz	Rubber Mallet-Wood Hickory Handle	
82881	Folding	Utility Knife	
83131	Intermediate	Aviation Set	
83132	Intermediate	Aviation Set	
82041	10"	Curved Jaw Locking Pliers	
82043	6"	Long Nose Locking Pliers	
82050	11"	Swivel Pad C-Clamp Locking Pliers	
69-990	Safety	Glasses	

KD® Specialty Tools

KDS129	Low Voltage	Circuit Tester	
KDS485	Gasket	Scraper	
KDS2840	Telescoping	Mirrors	
KDS2593	Telescoping	Magnetic Pick-Up Tool	
KDS3151	Interchangeable	Snap Ring Pliers	
KDS2162	Wire Stripper	Crimper	
KDS2038	Window Molding	Remover	
KDS431	Door Handle	Window Lift Remover	
KDS2822	Trim Pad	Removal Tool	
KDS3729	Push Pin	Pliers	
KDS2979	Scribe		
KDS2106	All Purpose	Sticker Scraper Tool	
KDS2311	Shoe Handle	Wire Scratch Brush	
KDS2426	3"	Putty/Knife Scraper	
KDS2425	1-1/4"	Putty/Knife Scraper	

Not all tools GearWrench® Branded

83096 - Intermediate Diesel TEP Set



1/4" Drive Sockets

80302 13 Pc. 6 Pt. Metric Socket Set

80125	4mm	80132	10mm
80126	5mm	80133	11mm
80127	5.5mm	80134	12mm
80128	6mm	80135	13mm
80129	7mm	80136	14mm
80130	8mm	80137	15mm
80131	9mm		

80303 10 Pc. 6 Pt. SAE Socket Set

80105	3/16"	80110	11/32"
80106	7/32"	80111	3/8"
80107	1/4"	80112	7/16"
80108	9/32"	80113	1/2"
80109	5/16"	80114	9/16"

3/8" Drive Sockets

80552 14 Pc. 6 Pt. Metric Socket Set

80374	6mm	80381	13mm
80375	7mm	80382	14mm
80376	8mm	80383	15mm
80377	9mm	80384	16mm
80378	10mm	80385	17mm
80379	11mm	80386	18mm
80380	12mm	80387	19mm

80553 13 Pc. 6 Pt. SAE Socket Set

80350	1/4"	80357	11/16"
80351	5/16"	80358	3/4"
80352	3/8"	80359	13/16"
80353	7/16"	80360	7/8"
80354	1/2"	80361	15/16"
80355	9/16"	80362	1"
80356	5/8"		

80554 14 Pc. 6 Pt. Deep Metric Socket Set

80388	6mm	80395	13mm
80389	7mm	80396	14mm
80390	8mm	80397	15mm
80391	9mm	80398	16mm
80392	10mm	80399	17mm
80393	11mm	80400	18mm
80394	12mm	80401	19mm

80555 11 Pc. 6 Pt. Deep SAE Socket Set

80363	1/4"	80369	9/16"
80364	5/16"	80370	5/8"
80365	3/8"	80371	3/4"
80366	1/4"	80372	13/16"
80367	7/16"	80373	7/8"
80368	1/2"		

1/2" Drive Sockets

80702 13 Pc. 6 Pt. Metric Socket Set

81624	12mm	81631	19mm
81625	13mm	81632	20mm

81626	14mm	81633	21mm
81627	15mm	81634	22mm
81628	16mm	81635	23mm
81629	17mm	81636	24mm
81630	18mm		

80703 11 Pc. 6 Pt. SAE Socket Set

80603	1/2"	80609	7/8"
80604	9/16"	80610	15/16"
80605	5/8"	80611	1"
80606	11/16"	80612	1-1/16"
80607	3/4"	80613	1-1/8"
80608	13/16"		

80704 10 Pc. 6 Pt. Deep Metric Socket Set

80637	10mm	80642	15mm
80638	11mm	80643	16mm
80629	17mm	80644	17mm
80640	13mm	80645	18mm
80641	14mm	80646	19mm

80705 8 Pc. 6 Pt. Deep SAE Socket Set

80614	1/2"	80618	3/4"
80615	9/16"	80619	13/16"
80616	5/8"	80620	7/8"
80617	11/16"	80621	15/16"

1/4", 3/8", 1/2" Drive Sockets

81206 3 Pc. Full Polish Ratchet Set

81011	Full Polish Teardrop Ratchet 1/4" Drive
81211	Full Polish Teardrop Ratchet 3/8" Drive
81304	Full Polish Teardrop Ratchet 1/2" Drive
81113	3" Extension 1/4" Drive
80100	Universal Joint 1/4" Drive
81128	Spinner Handle 1/4" Drive
81241	3" Extension 3/8" Drive
81242	6" Extension 3/8" Drive
80549	Universal Joint 3/8" Drive
80402	Intermediate Diesel Set
80403	13/16" Spark Plug Socket 3/8" Dr.
80600	Universal Joint 1/2" Drive
81341	5" Extension 1/2" Drive
81307	Full Polish Flex Handle 1/2" Drive

Combinations Wrenches

81917 18 Pc. Long Pattern Combination Non-Ratcheting Wrench Set SAE

81650	1/4"	81659	11/16"
81651	9/32"	81660	3/4"
81652	5/16"	81661	13/16"
81653	11/32"	81662	7/8"
81654	3/8"	81663	15/16"
81655	7/16"	81664	1"
81656	1/2"	81733	1-1/6"
81657	9/16"	81734	1-1/8"
81658	5/8"	81735	1-1/4"

81916 22 Pc. Long Pattern Combination Non-Ratcheting Wrench Metric

81736	6mm	81674	17mm
81737	7mm	81675	18mm
81665	8mm	81676	19mm
81666	9mm	81677	20mm
81667	10mm	81678	21mm
81668	11mm	81679	22mm
81669	12mm	81741	23mm
81670	13mm	81742	24mm
81671	14mm	81743	27mm
81672	15mm	81744	30mm
81673	16mm	81745	32mm

Screwdrivers and Pliers

80051 12 Pc. Combination Screwdriver Set

80012	1/4" x 1-1/2" Slotted
80018	3/16" x 6" Slotted w/ Cabinet Tip
80013	1/4" x 4" Slotted w/Hex Bolster
80014	1/4" x 6" Slotted w/Hex Bolster
80023	5/16" x 6" Slotted w/Hex Bolster
80022	3/8" x 8" Slotted w/Hex Bolster
80000	#0 x 2-1/2" Phillips
80001	#1 x 3" Phillips
80004	#1 x 6" Phillips
80005	#2 x 1-1/2" Phillips
80007	#2 x 4" Phillips w/ Hex Bolster
80011	#3 x 6" Phillip w/Hex Bolster

82103 4 Pc. Mixed Pliers Set

82011	9.5" Tongue and Groove
82012	7" Diagonal Cutting
82013	8" Long Nose
82005	Straight Double-X™

Hex Keys

56603G 13 Pc. SAE ALLEN® Hex Key Set

Sizes: 0.050", 1/16", 5/64", 3/32", 7/64", 1/8", 9/64", 5/32", 3/16", 7/32", 1/4", 5/16", 3/8"

56615G 9 Pc. SAE ALLEN® Ball End Hex Key Set

Sizes: 1.5, 2, 2.5, 3, 4, 5, 6, 8, 10mm

Punch & Chisel

82305 12 Pc. Punch and Chisel Set

82261	1/4" x 4-3/4" x 1/4" Cold Chisel
82262	3/8" x 5" x 5/16" Cold Chisel
82264	1/2" x 6" x 3/8" Cold Chisel
82265	5/8" x 6-1/2" x 3/8" Cold Chisel
82270	3/8" x 5" Center Punch
82272	3/32" x 4-3/4" x 5/16" Pin Punch
82273	1/8" x 5" x 5/16" Pin Punch
82274	5/32" x 5-1/4" x 5/16" Pin Punch
82275	3/16" x 5-1/2" x 5/16" Pin Punch

82278	1/8" x 8" x 3/8" Long Taper Punch
82283	3/16" x 5" x 3/8" Starter Punch
82285	1/8" x 4-1/2" x 5/16" Long Taper Punch

Torx® Bit Sockets

80723 13 Pc. Torx® Press Fit Bit Socket Set

80171	T-8, 1/4" Drive
80172	T-10, 1/4" Drive
80173	T-15, 1/4" Drive
80174	T-20, 1/4" Drive
80175	T-25, 1/4" Drive
80176	T-27, 1/4" Drive
80177	T-30, 1/4" Drive
80451	T-40, 3/8" Drive
80452	T-45, 3/8" Drive
80453	T-47, 3/8" Drive
80454	T-50, 3/8" Drive
80455	T-55, 3/8" Drive
80667	T-60, 1/2" Drive

General Purpose Tools

82220	18" to 29" Extendable Pry Bar
82880	High Tension Hacksaw
82251	16 oz Ball Pein Hammer - Fiberglass
82260	12 oz Softface Hammer Removable Caps
82255	3 lb Drilling Hammer
82259	16 oz Rubber Mallet - Wood Hickory Handle
82881	Folding Utility Knife
83131	16" Tape Measure SAE/Metric
83132	Aluminum Flashlight
82102	3 Pc. Locking Pliers Set
82043	Long Nose Locking Pliers 6"
82040	Curved Jaw Locking Pliers 5"
82041	Curved Jaw Locking Pliers 10"
69-990	Safety Glasses

KD® Specialty Tools

KDS129	Low Voltage Circuit Tester
KDS162	16 Blade Feeler Gauge
KDS485	Gasket Scraper
KDS2282	Slotted Screw Starter
KDS2283	Phillips Screw Starter
KDS2840	Telescoping Mirror
KDS2593	Telescoping Magnetic Pick-Up Tool
KDS2162	Wire Stripper Crimper

Not all tools GearWrench® Branded



83080 - Aviation Introductory TEP Set

Screwdrivers and Pliers

- 80050 6 Pc. Combination Screwdriver Set
- 80015 1/8" x 3" Slotted w/Cabinet Tip
- 80013 1/4" x 4" Slotted w/Hex Bolster
- 80023 5/16" x 6" Slotted w/Hex Bolster
- 80022 3/8" x 8" Slotted w/Hex Bolster
- 80001 #1 x 3" Phillips
- 80007 #2 x 4" Phillips w/Hex Bolster
- 82103 4 Pc. Mixed Pliers Set
- 82011 9.5" Tongue and Groove
- 82012 7" Diagonal Cutting
- 82013 8" Long Nose
- 82014 8" Slip Joint

General Purpose Tools

- 82251 16 oz Ball Pein Hammer-Fiberglass
- 82260 12 oz Softface Hammer Removable Caps
- 82881 Folding Utility Knife
- 83132 Aluminum Flashlight
- 82041 10" Curved Jaw Locking Pliers
- 69-990 Safety Glasses
- 9-HLQM24 Hearing Protection

KD® Specialty Tools

- KDS2391 23" Flexible Pick-Up Tool
- KDS2840 Telescoping Mirror
- KDS2593 Telescoping Magnetic Pick-Up Tool
- KDS2282 Slotted Screw Starter
- KDS2283 Phillips Screw Starter
- KDS2425 1-1/4" Putty Knife/Scrapper
- KDS2979 Scribe
- KDS2162 Wire Stripper Crimper

Tool Storage

- 83130 Tool Box with Tote

Not all tools GearWrench® Branded

1/4" Drive Sockets

- 80307 10 Pc. 12 Pt. SAE Socket Set
- 80210 3/16" 80215 11/32"
- 80211 7/32" 80216 3/8"
- 80212 1/4" 80217 7/16"
- 80213 9/32" 80218 1/2"
- 80214 5/16" 80219 9/16"
- 80305 10 Pc. 6 Pt. Deep SAE Socket Set
- 80115 3/16" 80120 11/32"
- 80116 7/32" 80121 3/8"
- 80117 1/4" 80122 7/16"
- 80118 9/32" 80123 1/2"
- 80119 5/16" 80124 9/16"

1/4" Drive Tools

- 81011 Full Polish Teardrop Ratchet
- 81113 3" Extension
- 81116 6" Extension

- 81128 Spinner Handle
- 80100 Universal Joint

3/8" Drive Sockets

- 80561 13 Pc. 12 Pt. SAE Socket Set
- 80496 1/4" 80503 11/16"
- 80497 5/16" 80504 3/4"
- 80498 3/8" 80505 13/16"
- 80499 7/16" 80506 7/8"
- 80500 1/2" 80507 15/16"
- 80501 9/16" 80508 1"
- 80502 5/8"
- 80563 11 Pc. 12 Pt. Deep SAE Socket Set
- 80509 1/4" 80515 9/16"
- 80510 5/16" 80516 5/8"
- 80511 3/8" 80517 11/16"
- 80512 1/4" 80518 3/4"
- 80513 7/16" 80519 7/8"

- 80514 1/2"

3/8" Drive Tools

- 81211 Full Polish Teardrop Ratchet
- 81242 6" Extension
- 80549 Universal Joint
- 11-935 Speeder Handle

Combination Wrenches

- 81901 15 Pc. SAE Long Pattern Combination Non-Ratcheting Wrench Set
- 81650 1/4" 81658 5/8"
- 81651 9/32" 81659 11/16"
- 81652 5/16" 81660 3/4"
- 81653 11/32" 81661 13/16"
- 81654 3/8" 81662 7/8"
- 81655 7/16" 81663 15/16"
- 81656 1/2" 81664 1"
- 81657 9/16"

83098 - Intermediate Aviation TEP Set

1/4" Drive Sockets

80307	10 Pc. 12 Pt. SAE Socket Set
80210	3/16" 80215 11/32"
80211	7/32" 80216 3/8"
80212	1/4" 80217 7/16"
80213	9/32" 80218 1/2"
80214	5/16" 80219 9/16"

80305	10 Pc. 6 Pt. Deep SAE Socket Set
80115	3/16" 80120 11/32"
80116	7/32" 80121 3/8"
80117	1/4" 80122 7/16"
80118	9/32" 80123 1/2"
80119	5/16" 80124 9/16"

80310	7 Pc. 6 Pt. SAE Flex Socket Set
80262	3/16" 80266 7/16"
80263	1/4" 80267 1/2"
80264	5/16" 80268 9/16"
80265	3/8"

1/4" Drive Tools

81011	Full Polish Teardrop Ratchet
81113	3" Extension
81116	6" Extension
81128	Spinner Handle
80100	Universal Joint

3/8" Drive Sockets

80561	13 Pc. 12 Pt. SAE Socket Set
80496	1/4" 80503 11/16"
80497	5/16" 80504 3/4"
80498	3/8" 80505 13/16"
80499	7/16" 80506 7/8"
80500	1/2" 80507 15/16"
80501	9/16" 80508 1"
80502	5/8"

80563	11 Pc. 12 Pt. Deep SAE Socket Set
80509	1/4" 80515 9/16"
80510	5/16" 80516 5/8"
80511	3/8" 80517 11/16"
80512	1/4" 80518 3/4"
80513	7/16" 80519 7/8"
80514	1/2"

3/8" Drive Tools

81211	Full Polish Teardrop Ratchet
81241	3" Extension
81242	6" Extension
80549	Universal Joint
80402	5/8" Spark Plug Socket
80403	13/16" Spark Plug Socket
11-935	Speeder Handle

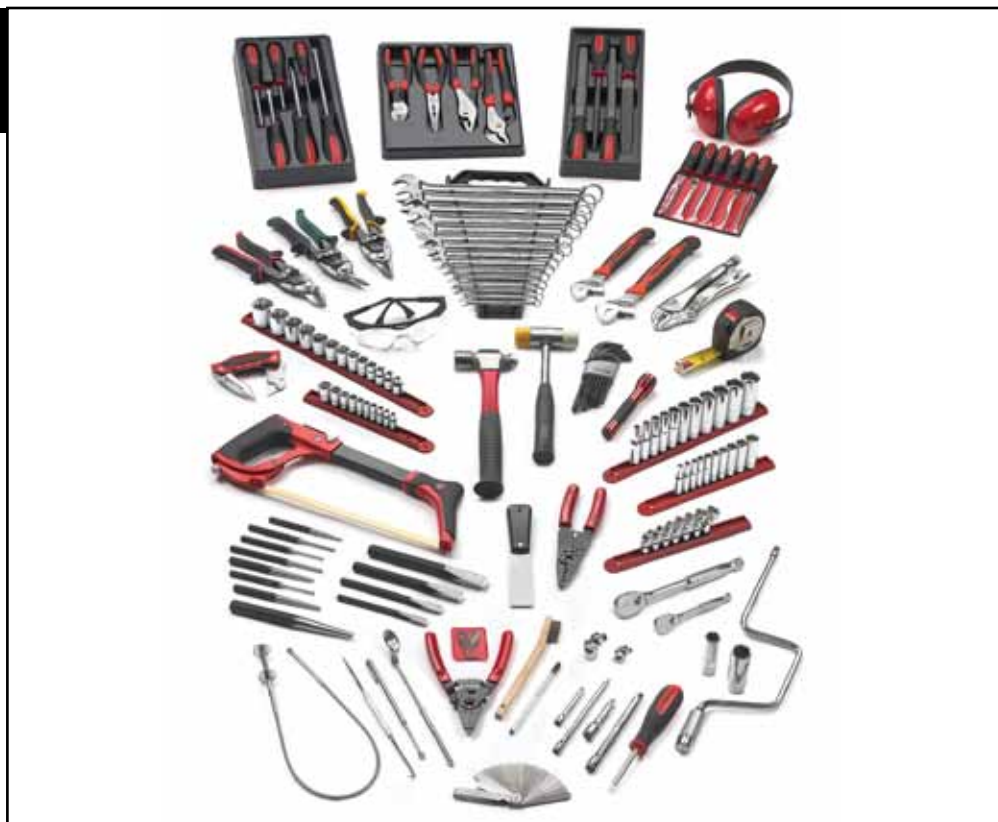

Hex Keys

56612G	13 Pc. SAE ALLEN® Ball End Hex Key Set
Sizes: Sizes: 0.050", 1/16", 5/64", 3/32", 7/64", 1/8", 9/64", 5/32", 3/16", 7/32", 1/4", 5/16", 3/8"	

Screwdrivers and Pliers

80050	6 Pc. Combination Screwdriver Set
80015	1/8" x 3" Slotted w/Cabinet Tip
80013	1/4" x 4" Slotted w/Hex Bolster
80023	5/16" x 6" Slotted w/Hex Bolster
80022	3/8" x 8" Slotted w/Hex Bolster
80001	#1 x 3" Phillips
80007	#2 x 4" Phillips w/Hex Bolster
82103	4 Pc. Mixed Pliers Set
82011	9.5" Tongue and Groove
82012	7" Diagonal Cutting
82013	8" Long Nose
82014	8" Slip Joint

Cutting Tools

82841	Right Cutting Aviation Snips
82842	Left Cutting Aviation Snips
82843	3 Pc. Aviation Snip Set

Files, Punches & Chisels

82820	4 Pc. STD File Set
--------------	---------------------------

82822	8" Flat
82823	8" Round
82824	8" Half Round
82825	8" Triangle File
82821	6 Pc. Mini File Set
82826	4" Flat Mini
82827	4" Half Round Mini
82828	4" Round Mini
82829	4" Triangle Mini
82830	4" Square Mini
82831	4" Knife Mini

82305	12 Pc. Punch and Chisel Set
82261	1/4" x 4-3/4" x 1/4" Cold Chisel
82262	3/8" x 5" x 5/16" Cold Chisel
82264	1/2" x 6" x 3/8" Cold Chisel
82265	5/8" x 6-1/2" x 3/8" Cold Chisel
82270	3/8" x 5" Center Punch
82272	3/32" x 4-3/4" x 5/16" Pin Punch
82273	1/8" x 5" x 5/16" Pin Punch
82274	5/32" x 5-1/4" x 5/16" Pin Punch
82275	3/16" x 5-1/2" x 5/16" Pin Punch
82278	1/8" x 8" x 3/8" Long Taper Punch
82283	3/16" x 5" x 3/8" Starter Punch
82285	1/8" x 4-1/2" x 5/16" Long Taper Punch

General Purpose Tools

81891	8" Adjustable Cushion Grip Wrench
-------	-----------------------------------

81893	12" Adjustable Cushion Grip Wrench
82880	High Tension Hacksaw
82251	16 oz Ball Pein Hammer - Fiberglass
82260	12 oz Softface Hammer Removable Caps
82881	Folding Utility Knife
82131	16" Tape Measure SAE/Metric
83132	Aluminum Flashlight
82040	5" Curved Jaw Locking Pliers
69-990	Safety Glasses
9-HLQM24	Hearing Protection

KD® Specialty Tools

KDS2391	23" Flexible Pick-Up Tool
KDS2109	Telescoping Mirror
KDS2593	Telescoping Magnetic Pick-Up Tools
KDS2282	Slotted Screw Starter
KDS2283	Phillips Screw Starter
KDS2425	1-14" Putty Knife/Scrapper
KDS2979	Scribe
KDS2309	Stainless Steel Brush
KDS3151	Interchangeable Snap Ring Pliers
KDS2162	Wire Stripper Crimper
KDS162	16 Blade Feeler Gauge

Not all tools GearWrench® Branded

**YOU'RE GONNA NEED
A BIGGER BOX**



TOOL STORAGE



Tool Storage

XL Series
Ball Bearing Series
Tool Storage Accessories

**GEARWRENCH XL SERIES
TOOL STORAGE**

TOOL STORAGE



Trigger Lock drawer system keeps drawers in place and opens with a natural pull operation

All drawers feature Auto Return, which snaps the drawers closed in the final inches of operation



Formed with rolled over drawer walls add strength and rigidity



Double Ball-Bearing construction offers exceptional load capacity and easy slide action

GearWrench now offers the industrial strength XL Tool Storage series. Professionals have come to expect innovation and increased productivity when using GearWrench products; with the XL series you can continue to expect the same superior design and construction to make you more productive on the job. Choose XL when you need a tool storage system that stands up to your growing demands. Formed with rolled over drawer walls, heavy gauge steel bodies, and stamped drawer bottoms; the XL series provides the required strength, durability and rigidity to withstand your professional demands.



All drawers come with drawer liners

AVAILABLE IN:

- XL Tool Chests
- XL Tool Roller Cabinets
- X/ Tool Carts



Dual gas shocks on all lids offer support and easily controlled closure



A 9 mm top mat provides protection and support on all cabinets



Durable powder-coated full-polished lacquer coating protects against scratches and marring



Barrel style lock and key are unique combination for security and durability



High strength side lift handles are integrated into the box wall for added durability and lift capacity



One set of locking casters on all cabinets and carts

TOOL STORAGE



83158 - 53" 9 Drawer Roller Cabinet

Width (inch)	Depth (inch)	Height (inch)	Weight (lbs)	Load Wt. (lbs)	Storage Cubic Inch	Casters
53	19	39-1/2	326	1760	15,661	5"x 2" PU
Drawer Dimensions			Width (inch)	Depth (inch)	Height (inch)	Load Wt. (lbs)
3 Drawers			16	15-1/2	2-1/4	88
2 Drawers			29-1/2	15-1/2	2-1/4	88
1 Drawer			29-1/2	15-1/2	5-1/2	88
1 Drawer			29-1/2	15-1/2	8-1/2	88
1 Drawer			16	15-1/2	11-1/2	132
1 Drawer			48	15-1/2	3-3/4	132

• Caster Type: PU (Polyurethane)



83156 - 42" 8 Drawer Chest

Width (inch)	Depth (inch)	Height (inch)	Weight (lbs)	Storage Cubic Inch		
41	18-1/4	20-1/2	160	7814		
Drawer Dimensions			Width (inch)	Depth (inch)	Height (inch)	Load Wt. (lbs)
4 Drawers			22-1/2	15-1/2	2-1/4	88
4 Drawers			12	15-1/2	2-1/4	88



83157 - 42" 11 Drawer Roller Cabinet

Width (inch)	Depth (inch)	Height (inch)	Weight (inch)	Load Wt. (lbs)	Storage Cubic Inch	Casters
42	19	39	286	1210	12,320	5"x 2" TPR
Drawer Dimensions			Width (inch)	Depth (inch)	Height (inch)	Load Wt. (lbs)
5 Drawers			22-3/4	15-1/2	2-1/4	88
3 Drawers			12-1/4	15-1/2	2-1/4	88
1 Drawer			12-1/4	15-1/2	11-3/4	132
1 Drawer			22-3/4	15-1/2	5-1/2	88
1 Drawer			36-3/4	15-1/2	3-3/4	132

• Caster Type: TPR (Thermoplastic Rubber)

83154 - 26" 4 Drawer Chest

Width (inch)	Depth (inch)	Height (inch)	Weight (lbs)	Storage Cubic Inch		
26	16	19	73	4547		
Drawer Dimensions			Width (inch)	Depth (inch)	Height (inch)	Load Wt. (lbs)
4 Drawers			25-3/4	17-1/2	2-3/4	88
1 Tray			17	6-3/4	1-3/4	20



TOOL STORAGE

83155 - 26" 7 Drawer Roller Cabinet

Width (inch)	Depth (inch)	Height (inch)	Weight (lbs)	Load Wt. (lbs)	Storage Cubic Inch	Casters
26-1/2	18	39	154	880	7673	5"x 2" PP
Drawer Dimensions			Width (inch)	Depth (inch)	Height (inch)	Load Wt. (lbs)
5 Drawers			22-1/4	15-1/2	2-1/4	88
2 Drawers			22-1/4	15-1/2	5-1/2	88

- Caster Type: PP (Polypropylene)





83152 - 2 Drawer Tool Cart

Width (inch)	Depth (inch)	Height (inch)	Weight (lbs)	Load Wt. (lbs)	Storage Cubic Inch	Casters
31-1/2	20-1/2	36	102	880	4641	4"x 1" TPR
Drawer Dimensions			Width (inch)	Depth (inch)	Height (inch)	Load Wt. (lbs)
2 Drawers			25-1/2	17-1/2	2-3/4	88

- Caster Type: TPR (Thermoplastic Rubber)



83153 - 4 Drawer Tool Cart

Width (inch)	Depth (inch)	Height (inch)	Weight (lbs)	Load Wt. (lbs)	Storage Cubic Inch	Casters
31-1/2	20-1/2	41	140	880	8585	5"x 2" PP
Drawer Dimensions			Width (inch)	Depth (inch)	Height (inch)	Load Wt. (lbs)
2 Drawers			12	17-1/2	2-3/4	88
1 Drawer			25-1/2	17-1/2	2-3/4	88
1 Drawer			25-1/2	17-1/2	6-1/4	132

- Caster Type: PP (Polypropylene)

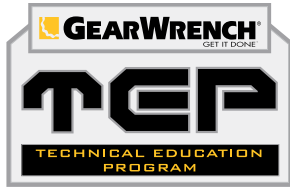

GearWrench Ball Bearing Series delivers exceptional value solutions for the next generation's technician investing for the future. All units feature a secure, durable, and lasting way to protect and organize all the tools needed for the job. Choose from an assortment of colors and drawer combinations to fit your unique style.

- Double-wall construction for a sturdy and durable frame
- Heavy-duty casters
- Durable easy-open ball-bearing slides
- High-gloss powder coat scratch-resistant finish
- Non-slip drawers

83126 - 42" 10 Drawer Chest

Width (inch)	Depth (inch)	Height (inch)	Weight (lbs)	Storage Cubic Inch		
40-1/2	17-7/8	18-3/8	115	6457		
Drawer Dimensions			Width (inch)	Depth (inch)	Height (inch)	Load Wt. (lbs)
3 Drawers			23	16	2	75
3 Drawers			11	16	2	75
2 Drawers			23	16	3	75
2 Drawers			11	16	3	75

Colors Available:

83126BK  83126RD  83126BU  83126OR 

83127 - 42" 11 Roller Cabinet

Width (inch)	Depth (inch)	Height (inch)	Weight (lbs)	Load Wt. (lbs)	Storage Cubic Inch	Casters
41-1/2	18-3/4	38-1/4	172	1100	12,328	5" x 2" PP
Drawer Dimensions			Width (inch)	Depth (inch)	Height (inch)	Load Wt. (lbs)
4 Drawers			23	16	3	75
2 Drawers			11	16	3	75
1 Drawer			23	16	2	75
1 Drawer			23	16	4-1/4	75
1 Drawer			11	16	4-1/4	75
1 Drawer			11	16	8-5/8	75
1 Drawer			38	16	4-1/4	75

Colors Available:

83127BK  83127RD  83127BU  83127OR 

- Caster Type: PP (Polypropylene)





83124 - 27" 6 Drawer Chest

Width (inch)	Depth (inch)	Height (inch)	Weight (lbs)	Load Wt. (lbs)	Storage Cubic Inch	
26	17-7/8	20-1/2	75	675	5991	
Drawer Dimensions			Width (inch)	Depth (inch)	Height (inch)	Load Wt. (lbs)
6 Drawers			23	16	2	75

Colors Available:
 83124BK  83124RD  83124BU 

83125 - 27" 7 Drawer Roller Cabinet

Width (inch)	Depth (inch)	Height (inch)	Weight (lbs)	Load Wt. (lbs)	Storage Cubic Inch	Casters
27	18-3/4	35-5/8	120	700	9604	5" x 2" PP
Drawer Dimensions			Width (inch)	Depth (inch)	Height (inch)	Load Wt. (lbs)
4 Drawers			23	16	2	75
2 Drawers			23	16	4	75
1 Drawer			23	16	6-1/2	75

Colors Available:
 83125BK  83125RD  83125BU 
 • Caster Type: PP (Polypropylene)



83122 - 27" 4 Drawer Chest

Width (inch)	Depth (inch)	Height (inch)	Weight (lbs)	Load Wt. (lbs)	Storage Cubic Inch	
26	12	14-1/2	41 lbs	375	3171	
Drawer Dimensions			Width (inch)	Depth (inch)	Height (inch)	Load Wt. (lbs)
3 Drawers			23	10-1/2	2	75
1 Drawer			23	10-1/2	2-1/2	75

Colors Available:
 83122BK  83122RD  83122BU 

83123 - 27" 5 Drawer Roller Cabinet

Width (inch)	Depth (inch)	Height (inch)	Weight (lbs)	Load Wt. (lbs)	Storage Cubic Inch	Casters
27	18-3/4	31-1/4	82	500	6594	5" x 2" PP
Drawer Dimensions			Width (inch)	Depth (inch)	Height (inch)	Load Wt. (lbs)
4 Drawers			23	16	4	75
1 Drawer			23	16	2	75

Colors Available:
 83123BK  83123RD  83123BU 
 • Caster Type: PP (Polypropylene)

83148 - Plastic Tool Box

Length (inch)	Width (inch)	Depth (inch)	Weight (lbs)
7-3/4	16-1/2	8-1/2	3.701

- Plastic hand box with comfort grip handle
- Includes tote tray and two compartments in lid



83130 - 19" Tote Box

Length (inch)	Width (inch)	Depth (inch)	Weight (lbs)
19	6	6-1/2	10

- Dual latch with lock clasps
- Includes tote tray



83147 - 16" Tool Bag

Length (inch)	Width (inch)	Depth (inch)	Weight (lbs)
16	12-3/4	8	3.79

- All weather durable heavy-duty construction

* Tools pictured not included



83151 - 3 Drawer Tool Box

Length (inch)	Width (inch)	Depth (inch)	Weight (lbs)
12	20	8-1/2	17.84

- Portable tool box with ball bearing drawer slides
- Keyed center lock for security
- Includes cantilever tray



TOOL STORAGE

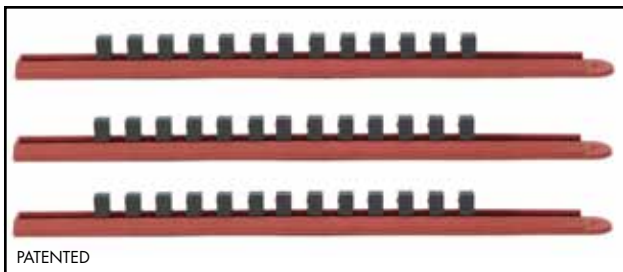

**83103 - 3 Pc. Slide Rail Socket System
1/4" 3/8" & 1/2" DRIVE**

Item No.	Description
83105	Red Slide Socket Rail 1/4" Drive
83101	Red Slide Socket Rail 3/8" Drive
83102	Red Slide Socket Rail 1/2" Drive

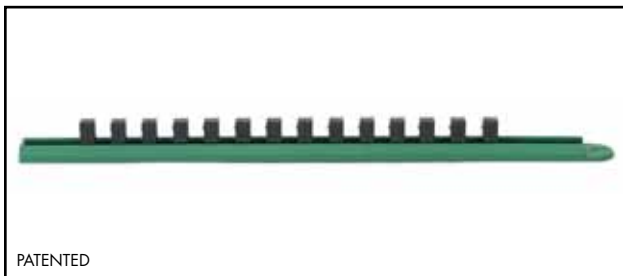

Open Stock - Socket Rails

Item No.	Description
83109	Green Slide Socket Rail 1/4" Drive
83110	Green Slide Socket Rail 3/8" Drive
83111	Green Slide Socket Rail 1/2" Drive
83105	Red Slide Socket Rail 1/4" Drive
83101	Red Slide Socket Rail 3/8" Drive
83102	Red Slide Socket Rail 1/2" Drive
83106	Blue Slide Socket Rail 1/4" Drive
83107	Blue Slide Socket Rail 3/8" Drive
83108	Blue Slide Socket Rail 1/2" Drive



Socket Rail Clips Sets

Item No.	Description
83112	3 Pc. Socket Rail Clips Set 1/4" Drive
83113	3 Pc. Socket Rail Clips Set 3/8" Drive
83114	3 Pc. Socket Rail Clips Set 1/2" Drive



**83104 - Universal Magnetic Parts Tray -
Circular**



**83115 - Universal Magnetic Parts Tray -
Rectangular**

RATCHETS, SOCKETS & DRIVE TOOLS



Drive Tools

Multidrive Sets
1/4" Drive Sets
1/4" Drive Open Stock
3/8" Drive Sets
3/8" Drive Open Stock

1/2" Drive Sets
1/2" Drive Open Stock
3/4" Drive Sets
3/4" Drive Open Stock

FULL POLISH RATCHETS

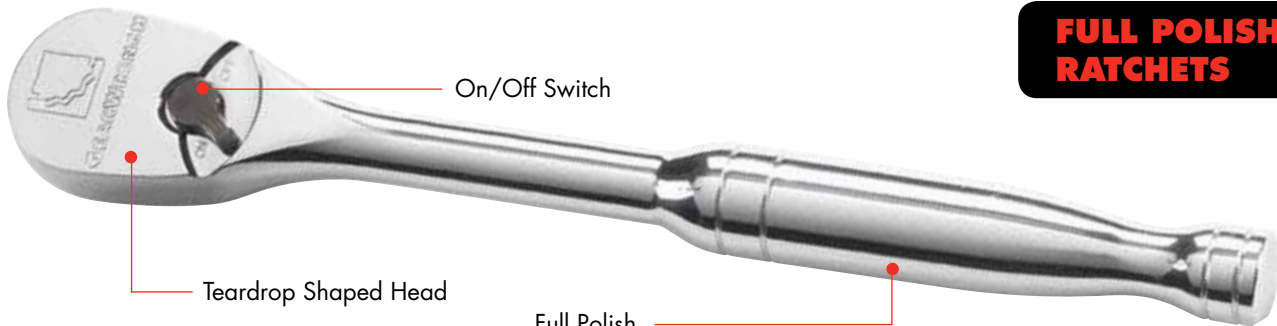

Lower profile head provides better access

AVAILABLE IN:

- Flex Head Ratchets
- Teardrop Head Ratchets
- Stubby Ratchets
- Offset Ratchets

CUSHION GRIP RATCHETS



ROTO RATCHETS



Head Rotates 180 Degrees
Less Than 5 Degree Swing Arc for Greater Access

APPLICATIONS

- Head bolts with variable obstructions
- Spark plug service
- In vertical position can speed down like a screwdriver
- In horizontal position, provides increased torque

SOCKETS



Entry angle guides fastener

Serration depth as deep as the fastener

AVAILABLE IN:

- Standard
- Deep
- Spark Plug
- Flex



Large hard-stamped identification

Double Line (SAE) & Knurled Line (MM) to easily identify Standard vs. Metric Sockets

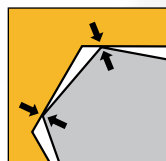

Ordinary Socket



Surface Drive® Technology

MAGNETIC DRIVE TOOLS



Knurled grip provides non-slip surface

APPLICATIONS

- Under dashboard
- Tight engine compartments
- Clean environments, where there is a need to contain fasteners from falling between gaps
- Tight access where two hands cannot fit

Strong magnetic tips allow for contact through the base of the socket to hold nuts and bolts in place during use



Magnetic tip keeps the fastener in the sockets

Products are covered by one or more of the following patents:
• US 7,185,566



80934 - 239 Pc. SAE/METRIC 6 & 12 Pt. Mechanics Tool Set MULTI DRIVE

Item No.	Description			
80104	5/32"	6 Pt.	Std. SAE Socket	1/4"Dr.
80105	3/16"	6 Pt.	Std. SAE Socket	1/4"Dr.
80106	7/32"	6 Pt.	Std. SAE Socket	1/4"Dr.
80107	1/4"	6 Pt.	Std. SAE Socket	1/4"Dr.
80108	9/32"	6 Pt.	Std. SAE Socket	1/4"Dr.
80109	5/16"	6 Pt.	Std. SAE Socket	1/4"Dr.
80110	11/32"	6 Pt.	Std. SAE Socket	1/4"Dr.
80111	3/8"	6 Pt.	Std. SAE Socket	1/4"Dr.
80112	7/16"	6 Pt.	Std. SAE Socket	1/4"Dr.
80113	1/2"	6 Pt.	Std. SAE Socket	1/4"Dr.
80114	9/16"	6 Pt.	Std. SAE Socket	1/4"Dr.
80125	4 mm	6 Pt.	Std. Metric Socket	1/4"Dr.
80126	5 mm	6 Pt.	Std. Metric Socket	1/4"Dr.
80127	5.5 mm	6 Pt.	Std. Metric Socket	1/4"Dr.
80128	6 mm	6 Pt.	Std. Metric Socket	1/4"Dr.
80129	7 mm	6 Pt.	Std. Metric Socket	1/4"Dr.
80130	8 mm	6 Pt.	Std. Metric Socket	1/4"Dr.
80131	9 mm	6 Pt.	Std. Metric Socket	1/4"Dr.
80132	10 mm	6 Pt.	Std. Metric Socket	1/4"Dr.
80133	11 mm	6 Pt.	Std. Metric Socket	1/4"Dr.
80134	12 mm	6 Pt.	Std. Metric Socket	1/4"Dr.
80135	13 mm	6 Pt.	Std. Metric Socket	1/4"Dr.
80136	14 mm	6 Pt.	Std. Metric Socket	1/4"Dr.
80137	15 mm	6 Pt.	Std. Metric Socket	1/4"Dr.
80115	3/16"	6 Pt.	Deep SAE Socket	1/4"Dr.
80116	7/32"	6 Pt.	Deep SAE Socket	1/4"Dr.
80117	1/4"	6 Pt.	Deep SAE Socket	1/4"Dr.

Item No.	Description			
80118	9/32"	6 Pt.	Deep SAE Socket	1/4"Dr.
80119	5/16"	6 Pt.	Deep SAE Socket	1/4"Dr.
80120	11/32"	6 Pt.	Deep SAE Socket	1/4"Dr.
80121	3/8"	6 Pt.	Deep SAE Socket	1/4"Dr.
80122	7/16"	6 Pt.	Deep SAE Socket	1/4"Dr.
80123	1/2"	6 Pt.	Deep SAE Socket	1/4"Dr.
80124	9/16"	6 Pt.	Deep SAE Socket	1/4"Dr.
80138	4 mm	6 Pt.	Deep Metric Socket	1/4"Dr.
80139	5 mm	6 Pt.	Deep Metric Socket	1/4"Dr.
80141	6 mm	6 Pt.	Deep Metric Socket	1/4"Dr.
80142	7 mm	6 Pt.	Deep Metric Socket	1/4"Dr.
80143	8 mm	6 Pt.	Deep Metric Socket	1/4"Dr.
80144	9 mm	6 Pt.	Deep Metric Socket	1/4"Dr.
80145	10 mm	6 Pt.	Deep Metric Socket	1/4"Dr.
80146	11 mm	6 Pt.	Deep Metric Socket	1/4"Dr.
80147	12 mm	6 Pt.	Deep Metric Socket	1/4"Dr.
80148	13 mm	6 Pt.	Deep Metric Socket	1/4"Dr.
80149	14 mm	6 Pt.	Deep Metric Socket	1/4"Dr.
80210	3/16"	12 Pt.	Std. SAE Socket	1/4"Dr.
80211	7/32"	12 Pt.	Std. SAE Socket	1/4"Dr.
80212	1/4"	12 Pt.	Std. SAE Socket	1/4"Dr.
80213	9/32"	12 Pt.	Std. SAE Socket	1/4"Dr.
80214	5/16"	12 Pt.	Std. SAE Socket	1/4"Dr.
80215	11/32"	12 Pt.	Std. SAE Socket	1/4"Dr.
80216	3/8"	12 Pt.	Std. SAE Socket	1/4"Dr.
80217	7/16"	12 Pt.	Std. SAE Socket	1/4"Dr.
80218	1/2"	12 Pt.	Std. SAE Socket	1/4"Dr.
80219	9/16"	12 Pt.	Std. SAE Socket	1/4"Dr.
81014	Quick-Release Teardrop Ratchet			1/4"Dr.
81101	2" Extension			1/4"Dr.
81113	3" Extension			1/4"Dr.
81116	6" Extension			1/4"Dr.
80350	1/4"	6 Pt.	Std. SAE Socket	3/8" Dr.
80351	5/16"	6 Pt.	Std. SAE Socket	3/8" Dr.
80352	3/8"	6 Pt.	Std. SAE Socket	3/8" Dr.
80353	7/16"	6 Pt.	Std. SAE Socket	3/8" Dr.
80354	1/2"	6 Pt.	Std. SAE Socket	3/8" Dr.
80355	9/16"	6 Pt.	Std. SAE Socket	3/8" Dr.
80356	5/8"	6 Pt.	Std. SAE Socket	3/8" Dr.
80357	11/16"	6 Pt.	Std. SAE Socket	3/8" Dr.

80934 - Continued

Item No.	Description			
80358	3/4"	6 Pt.	Std. SAE Socket	3/8" Dr.
80359	13/16"	6 Pt.	Std. SAE Socket	3/8" Dr.
80360	7/8"	6 Pt.	Std. SAE Socket	3/8" Dr.
80374	6 mm	6 Pt.	Std. Metric Socket	3/8" Dr.
80375	7 mm	6 Pt.	Std. Metric Socket	3/8" Dr.
80376	8 mm	6 Pt.	Std. Metric Socket	3/8" Dr.
80377	9 mm	6 Pt.	Std. Metric Socket	3/8" Dr.
80378	10 mm	6 Pt.	Std. Metric Socket	3/8" Dr.
80379	11 mm	6 Pt.	Std. Metric Socket	3/8" Dr.
80380	12 mm	6 Pt.	Std. Metric Socket	3/8" Dr.
80381	13 mm	6 Pt.	Std. Metric Socket	3/8" Dr.
80382	14 mm	6 Pt.	Std. Metric Socket	3/8" Dr.
80383	15 mm	6 Pt.	Std. Metric Socket	3/8" Dr.
80384	16 mm	6 Pt.	Std. Metric Socket	3/8" Dr.
80385	17 mm	6 Pt.	Std. Metric Socket	3/8" Dr.
80386	18 mm	6 Pt.	Std. Metric Socket	3/8" Dr.
80387	19 mm	6 Pt.	Std. Metric Socket	3/8" Dr.
80330	20 mm	6 Pt.	Std. Metric Socket	3/8" Dr.
80331	21 mm	6 Pt.	Std. Metric Socket	3/8" Dr.
80332	22 mm	6 Pt.	Std. Metric Socket	3/8" Dr.
80365	3/8"	6 Pt.	Deep SAE Socket	3/8" Dr.
80366	1/4"	6 Pt.	Deep SAE Socket	3/8" Dr.
80367	7/16"	6 Pt.	Deep SAE Socket	3/8" Dr.
80368	1/2"	6 Pt.	Deep SAE Socket	3/8" Dr.
80369	9/16"	6 Pt.	Deep SAE Socket	3/8" Dr.
80370	5/8"	6 Pt.	Deep SAE Socket	3/8" Dr.
80371	11/16"	6 Pt.	Deep SAE Socket	3/8" Dr.
80391	9 mm	6 Pt.	Deep Metric Socket	3/8" Dr.
80392	10 mm	6 Pt.	Deep Metric Socket	3/8" Dr.
80393	11 mm	6 Pt.	Deep Metric Socket	3/8" Dr.
80394	12 mm	6 Pt.	Deep Metric Socket	3/8" Dr.
80395	13 mm	6 Pt.	Deep Metric Socket	3/8" Dr.
80396	14 mm	6 Pt.	Deep Metric Socket	3/8" Dr.
80397	15 mm	6 Pt.	Deep Metric Socket	3/8" Dr.
80398	16 mm	6 Pt.	Deep Metric Socket	3/8" Dr.
80399	17 mm	6 Pt.	Deep Metric Socket	3/8" Dr.
80400	18 mm	6 Pt.	Deep Metric Socket	3/8" Dr.
80401	19 mm	6 Pt.	Deep Metric Socket	3/8" Dr.
80496	1/4"	12 Pt.	Std. SAE Socket	3/8" Dr.
80498	5/16"	12 Pt.	Std. SAE Socket	3/8" Dr.
80498	3/8"	12 Pt.	Std. SAE Socket	3/8" Dr.
80499	7/16"	12 Pt.	Std. SAE Socket	3/8" Dr.

Item No.	Description			
80500	1/2"	12 Pt.	Std. SAE Socket	3/8" Dr.
80501	9/16"	12 Pt.	Std. SAE Socket	3/8" Dr.
80502	5/8"	12 Pt.	Std. SAE Socket	3/8" Dr.
80503	11/16"	12 Pt.	Std. SAE Socket	3/8" Dr.
80504	3/4"	12 Pt.	Std. SAE Socket	3/8" Dr.
80505	13/16"	12 Pt.	Std. SAE Socket	3/8" Dr.
80506	7/8"	12 Pt.	Std. SAE Socket	3/8" Dr.
80482	6 mm	12 Pt.	Std. Metric Socket	3/8" Dr.
80483	7 mm	12 Pt.	Std. Metric Socket	3/8" Dr.
80484	8 mm	12 Pt.	Std. Metric Socket	3/8" Dr.
80485	9 mm	12 Pt.	Std. Metric Socket	3/8" Dr.
80486	10 mm	12 Pt.	Std. Metric Socket	3/8" Dr.
80487	11 mm	12 Pt.	Std. Metric Socket	3/8" Dr.
80488	12 mm	12 Pt.	Std. Metric Socket	3/8" Dr.
80489	13 mm	12 Pt.	Std. Metric Socket	3/8" Dr.
80490	14 mm	12 Pt.	Std. Metric Socket	3/8" Dr.
80491	15 mm	12 Pt.	Std. Metric Socket	3/8" Dr.
80492	16 mm	12 Pt.	Std. Metric Socket	3/8" Dr.
80493	17 mm	12 Pt.	Std. Metric Socket	3/8" Dr.
80494	18 mm	12 Pt.	Std. Metric Socket	3/8" Dr.
80495	19 mm	12 Pt.	Std. Metric Socket	3/8" Dr.
80596	20 mm	12 Pt.	Std. SAE Socket	3/8" Dr.
80597	21 mm	12 Pt.	Std. SAE Socket	3/8" Dr.
80598	22 mm	12 Pt.	Std. SAE Socket	3/8" Dr.
81218	Quick-Release Teardrop Ratchet			3/8" Dr.
82783	1/4" Magnetic Bit Holding Screwdriver			
81241	3" Extension			3/8" Dr.
81242	6" Extension			3/8" Dr.
80402	5/8"	Spark Plug Socket		3/8" Dr.
80403	13/16"	Spark Plug Socket		3/8" Dr.
80760	7/16"	12 Pt.	Std. SAE Socket	1/2" Dr.
80761	1/2"	12 Pt.	Std. SAE Socket	1/2" Dr.
80762	9/16"	12 Pt.	Std. SAE Socket	1/2" Dr.
80763	5/8"	12 Pt.	Std. SAE Socket	1/2" Dr.
80764	11/16"	12 Pt.	Std. SAE Socket	1/2" Dr.
80765	3/4"	12 Pt.	Std. SAE Socket	1/2" Dr.
80766	13/16"	12 Pt.	Std. SAE Socket	1/2" Dr.
80767	7/8"	12 Pt.	Std. SAE Socket	1/2" Dr.
80768	15/16"	12 Pt.	Std. SAE Socket	1/2" Dr.
80769	1"	12 Pt.	Std. SAE Socket	1/2" Dr.
80770	1-1/16"	12 Pt.	Std. SAE Socket	1/2" Dr.

MULTI-DRIVE SETS
RATCHETS, SOCKETS & DRIVE TOOLS

80934 - Continued

Item No.	Description
80771	1-1/8" 12 Pt. Std. SAE Socket 1/2" Dr.
80793	1-3/16" 12 Pt. Std. SAE Socket 1/2" Dr.
80794	1-1/4" 12 Pt. Std. SAE Socket 1/2" Dr.
80680	1-1/2" 12 Pt. Std. SAE Socket 1/2" Dr.
80750	15 mm 12 Pt. Std. Metric Socket 1/2" Dr.
80751	16 mm 12 Pt. Std. Metric Socket 1/2" Dr.
80752	17 mm 12 Pt. Std. Metric Socket 1/2" Dr.
80753	18 mm 12 Pt. Std. Metric Socket 1/2" Dr.
80754	19 mm 12 Pt. Std. Metric Socket 1/2" Dr.
80755	20 mm 12 Pt. Std. Metric Socket 1/2" Dr.
80756	21 mm 12 Pt. Std. Metric Socket 1/2" Dr.
80757	22 mm 12 Pt. Std. Metric Socket 1/2" Dr.
80758	23 mm 12 Pt. Std. Metric Socket 1/2" Dr.
80759	24 mm 12 Pt. Std. Metric Socket 1/2" Dr.
80811	25 mm 12 Pt. Std. Metric Socket 1/2" Dr.
80681	26 mm 12 Pt. Std. Metric Socket 1/2" Dr.
80812	27 mm 12 Pt. Std. Metric Socket 1/2" Dr.
81309	Quick-Release Teardrop Ratchet 1/2" Dr.
81340	3" Extension 1/2" Dr.
81341	5" Extension 1/2" Dr.
81650	1/4" 12 Pt. Non-Ratcheting Combination Wrench
81652	5/16" 12 Pt. Non-Ratcheting Combination Wrench
81653	11/32" 12 Pt. Non-Ratcheting Combination Wrench
81654	3/8" 12 Pt. Non-Ratcheting Combination Wrench
81655	7/16" 12 Pt. Non-Ratcheting Combination Wrench
81656	1/2" 12 Pt. Non-Ratcheting Combination Wrench
81657	9/16" 12 Pt. Non-Ratcheting Combination Wrench
81658	5/8" 12 Pt. Non-Ratcheting Combination Wrench
81659	11/16" 12 Pt. Non-Ratcheting Combination Wrench
81660	3/4" 12 Pt. Non-Ratcheting Combination Wrench
81736	6 mm 12 Pt. Non-Ratcheting Combination Wrench
81737	7 mm 12 Pt. Non-Ratcheting Combination Wrench
81665	8 mm 12 Pt. Non-Ratcheting Combination Wrench
81666	9 mm 12 Pt. Non-Ratcheting Combination Wrench
81667	10 mm 12 Pt. Non-Ratcheting Combination Wrench
81668	11 mm 12 Pt. Non-Ratcheting Combination Wrench
81669	12 mm 12 Pt. Non-Ratcheting Combination Wrench
81670	13 mm 12 Pt. Non-Ratcheting Combination Wrench
81671	14 mm 12 Pt. Non-Ratcheting Combination Wrench
81672	15 mm 12 Pt. Non-Ratcheting Combination Wrench
81673	16 mm 12 Pt. Non-Ratcheting Combination Wrench
81674	17 mm 12 Pt. Non-Ratcheting Combination Wrench

Item No.	Description
81675	18 mm 12 Pt. Non-Ratcheting Combination Wrench
81676	19 mm 12 Pt. Non-Ratcheting Combination Wrench
56603G	13 Pc. Hex Key
56606G	9 Pc. Metric Hex Key
#1	Bit Phillips
#2	Bit Phillips
#3	Bit Phillips
4mm	Bit Slotted
5mm	Bit Slotted
6mm	Bit Slotted
T40	Bit Torx®
T45	Bit Torx®
T50	Bit Torx®
3/16"	Nut Driver Bit
1/4"	Nut Driver Bit
5/16"	Nut Driver Bit
11/32"	Nut Driver Bit
3/8"	Nut Driver Bit
7/16"	Nut Driver Bit
1/2"	Nut Driver Bit
5 mm	Nut Driver Bit
6 mm	Nut Driver Bit
7 mm	Nut Driver Bit
8 mm	Nut Driver Bit
9 mm	Nut Driver Bit
10 mm	Nut Driver Bit
11 mm	Nut Driver Bit

RATCHETS, SOCKETS & DRIVE TOOLS

MULTI DRIVE SETS

80933 - 216 Pc. SAE/METRIC 6 & 12 Pt. Mechanics Tool Set MULTI DRIVE

Item No.	Description			
80104	5/32"	6 Pt.	Std. SAE Socket	1/4" Dr.
80105	3/16"	6 Pt.	Std. SAE Socket	1/4" Dr.
80106	7/32"	6 Pt.	Std. SAE Socket	1/4" Dr.
80107	1/4"	6 Pt.	Std. SAE Socket	1/4" Dr.
80108	9/32"	6 Pt.	Std. SAE Socket	1/4" Dr.
80109	5/16"	6 Pt.	Std. SAE Socket	1/4" Dr.
80110	11/32"	6 Pt.	Std. SAE Socket	1/4" Dr.
80111	3/8"	6 Pt.	Std. SAE Socket	1/4" Dr.
80112	7/16"	6 Pt.	Std. SAE Socket	1/4" Dr.
80113	1/2"	6 Pt.	Std. SAE Socket	1/4" Dr.
80114	9/16"	6 Pt.	Std. SAE Socket	1/4" Dr.
80125	4 mm	6 Pt.	Std. Metric Socket	1/4" Dr.
80126	5 mm	6 Pt.	Std. Metric Socket	1/4" Dr.
80127	5.5 mm	6 Pt.	Std. Metric Socket	1/4" Dr.
80128	6 mm	6 Pt.	Std. Metric Socket	1/4" Dr.
80129	7 mm	6 Pt.	Std. Metric Socket	1/4" Dr.
80130	8 mm	6 Pt.	Std. Metric Socket	1/4" Dr.
80131	9 mm	6 Pt.	Std. Metric Socket	1/4" Dr.
80132	10 mm	6 Pt.	Std. Metric Socket	1/4" Dr.
80133	11 mm	6 Pt.	Std. Metric Socket	1/4" Dr.
80134	12 mm	6 Pt.	Std. Metric Socket	1/4" Dr.
80135	13 mm	6 Pt.	Std. Metric Socket	1/4" Dr.
80136	14 mm	6 Pt.	Std. Metric Socket	1/4" Dr.
80137	15 mm	6 Pt.	Std. Metric Socket	1/4" Dr.
80115	3/16"	6 Pt.	Deep SAE Socket	1/4" Dr.
80116	7/32"	6 Pt.	Deep SAE Socket	1/4" Dr.
80117	1/4"	6 Pt.	Deep SAE Socket	1/4" Dr.
80118	9/32"	6 Pt.	Deep SAE Socket	1/4" Dr.
80119	5/16"	6 Pt.	Deep SAE Socket	1/4" Dr.
80120	11/32"	6 Pt.	Deep SAE Socket	1/4" Dr.
80121	3/8"	6 Pt.	Deep SAE Socket	1/4" Dr.
80122	7/16"	6 Pt.	Deep SAE Socket	1/4" Dr.
80123	1/2"	6 Pt.	Deep SAE Socket	1/4" Dr.
80124	9/16"	6 Pt.	Deep SAE Socket	1/4" Dr.
80138	4 mm	6 Pt.	Deep Metric Socket	1/4" Dr.
80139	5 mm	6 Pt.	Deep Metric Socket	1/4" Dr.
80141	6 mm	6 Pt.	Deep Metric Socket	1/4" Dr.
80142	7 mm	6 Pt.	Deep Metric Socket	1/4" Dr.



Item No.	Description			
80143	8 mm	6 Pt.	Deep Metric Socket	1/4" Dr.
80144	9 mm	6 Pt.	Deep Metric Socket	1/4" Dr.
80145	10 mm	6 Pt.	Deep Metric Socket	1/4" Dr.
80146	11 mm	6 Pt.	Deep Metric Socket	1/4" Dr.
80147	12 mm	6 Pt.	Deep Metric Socket	1/4" Dr.
80148	13 mm	6 Pt.	Deep Metric Socket	1/4" Dr.
80149	14 mm	6 Pt.	Deep Metric Socket	1/4" Dr.
81014	Quick-Release Teardrop Ratchet			1/4" Dr.
81113	3" Extension			1/4" Dr.
81128	Spinner Handle			1/4" Dr.
80480	1/4"	Bit Holder Socket		1/4" Dr.
80350	1/4"	6 Pt.	Std. SAE Socket	3/8" Dr.
80351	5/16"	6 Pt.	Std. SAE Socket	3/8" Dr.
80352	3/8"	6 Pt.	Std. SAE Socket	3/8" Dr.
80353	7/16"	6 Pt.	Std. SAE Socket	3/8" Dr.
80354	1/2"	6 Pt.	Std. SAE Socket	3/8" Dr.
80355	9/16"	6 Pt.	Std. SAE Socket	3/8" Dr.
80356	5/8"	6 Pt.	Std. SAE Socket	3/8" Dr.
80357	11/16"	6 Pt.	Std. SAE Socket	3/8" Dr.
80358	3/4"	6 Pt.	Std. SAE Socket	3/8" Dr.
80359	13/16"	6 Pt.	Std. SAE Socket	3/8" Dr.
80360	7/8"	6 Pt.	Std. SAE Socket	3/8" Dr.
80377	9 mm	6 Pt.	Std. Metric Socket	3/8" Dr.
80378	10 mm	6 Pt.	Std. Metric Socket	3/8" Dr.
80379	11 mm	6 Pt.	Std. Metric Socket	3/8" Dr.

MULTI DRIVE SETS
RATCHETS, SOCKETS & DRIVE TOOLS

80933 - Continued

Item No.	Description			
80380	12 mm	6 Pt.	Std. Metric Socket	3/8" Dr.
80381	13 mm	6 Pt.	Std. Metric Socket	3/8" Dr.
80382	14 mm	6 Pt.	Std. Metric Socket	3/8" Dr.
80383	15 mm	6 Pt.	Std. Metric Socket	3/8" Dr.
80384	16 mm	6 Pt.	Std. Metric Socket	3/8" Dr.
80385	17 mm	6 Pt.	Std. Metric Socket	3/8" Dr.
80386	18 mm	6 Pt.	Std. Metric Socket	3/8" Dr.
80387	19 mm	6 Pt.	Std. Metric Socket	3/8" Dr.
80330	20 mm	6 Pt.	Std. Metric Socket	3/8" Dr.
80331	21 mm	6 Pt.	Std. Metric Socket	3/8" Dr.
80332	22 mm	6 Pt.	Std. Metric Socket	3/8" Dr.
80365	3/8"	6 Pt.	Deep SAE Socket	3/8" Dr.
80366	1/4"	6 Pt.	Deep SAE Socket	3/8" Dr.
80367	7/16"	6 Pt.	Deep SAE Socket	3/8" Dr.
80368	1/2"	6 Pt.	Deep SAE Socket	3/8" Dr.
80369	9/16"	6 Pt.	Deep SAE Socket	3/8" Dr.
80370	5/8"	6 Pt.	Deep SAE Socket	3/8" Dr.
80371	1 1/16"	6 Pt.	Deep SAE Socket	3/8" Dr.
80391	9 mm	6 Pt.	Deep Metric Socket	3/8" Dr.
80392	10 mm	6 Pt.	Deep Metric Socket	3/8" Dr.
80393	11 mm	6 Pt.	Deep Metric Socket	3/8" Dr.
80394	12 mm	6 Pt.	Deep Metric Socket	3/8" Dr.
80395	13 mm	6 Pt.	Deep Metric Socket	3/8" Dr.
80396	14 mm	6 Pt.	Deep Metric Socket	3/8" Dr.
80397	15 mm	6 Pt.	Deep Metric Socket	3/8" Dr.
80398	16 mm	6 Pt.	Deep Metric Socket	3/8" Dr.
80399	17 mm	6 Pt.	Deep Metric Socket	3/8" Dr.
80400	18 mm	6 Pt.	Deep Metric Socket	3/8" Dr.
80401	19 mm	6 Pt.	Deep Metric Socket	3/8" Dr.
80496	1/4"	12 Pt.	Std. SAE Socket	3/8" Dr.
80497	5/16"	12 Pt.	Std. SAE Socket	3/8" Dr.
80498	3/8"	12 Pt.	Std. SAE Socket	3/8" Dr.
80499	7/16"	12 Pt.	Std. SAE Socket	3/8" Dr.
80500	1/2"	12 Pt.	Std. SAE Socket	3/8" Dr.
80501	9/16"	12 Pt.	Std. SAE Socket	3/8" Dr.
80502	5/8"	12 Pt.	Std. SAE Socket	3/8" Dr.
80503	1 1/16"	12 Pt.	Std. SAE Socket	3/8" Dr.
80504	3/4"	12 Pt.	Std. SAE Socket	3/8" Dr.
80505	13/16"	12 Pt.	Std. SAE Socket	3/8" Dr.
80506	7/8"	12 Pt.	Std. SAE Socket	3/8" Dr.

Item No.	Description			
80485	9 mm	12 Pt.	Std. Metric Socket	3/8" Dr.
80486	10 mm	12 Pt.	Std. Metric Socket	3/8" Dr.
80487	11 mm	12 Pt.	Std. Metric Socket	3/8" Dr.
80488	12 mm	12 Pt.	Std. Metric Socket	3/8" Dr.
80489	13 mm	12 Pt.	Std. Metric Socket	3/8" Dr.
80490	14 mm	12 Pt.	Std. Metric Socket	3/8" Dr.
80491	15 mm	12 Pt.	Std. Metric Socket	3/8" Dr.
80492	16 mm	12 Pt.	Std. Metric Socket	3/8" Dr.
80493	17 mm	12 Pt.	Std. Metric Socket	3/8" Dr.
80494	18 mm	12 Pt.	Std. Metric Socket	3/8" Dr.
80495	19 mm	12 Pt.	Std. Metric Socket	3/8" Dr.
80596	20 mm	12 Pt.	Std. SAE Socket	3/8" Dr.
80597	21 mm	12 Pt.	Std. SAE Socket	3/8" Dr.
80598	22 mm	12 Pt.	Std. SAE Socket	3/8" Dr.
81218	Quick-Release Teardrop Ratchet			3/8" Dr.
81241	3" Extension			3/8" Dr.
81242	6" Extension			3/8" Dr.
80402	5/8"	Spark Plug Socket		3/8" Dr.
80403	13/16"	Spark Plug Socket		3/8" Dr.
80760	7/16"	12 Pt.	Std. SAE Socket	1/2" Dr.
80761	1/2"	12 Pt.	Std. SAE Socket	1/2" Dr.
80762	9/16"	12 Pt.	Std. SAE Socket	1/2" Dr.
80763	5/8"	12 Pt.	Std. SAE Socket	1/2" Dr.
80764	11/16"	12 Pt.	Std. SAE Socket	1/2" Dr.
80765	3/4"	12 Pt.	Std. SAE Socket	1/2" Dr.
80766	13/16"	12 Pt.	Std. SAE Socket	1/2" Dr.
80767	7/8"	12 Pt.	Std. SAE Socket	1/2" Dr.
80768	15/16"	12 Pt.	Std. SAE Socket	1/2" Dr.
80769	1"	12 Pt.	Std. SAE Socket	1/2" Dr.
80770	1-1/16"	12 Pt.	Std. SAE Socket	1/2" Dr.
80771	1-1/8"	12 Pt.	Std. SAE Socket	1/2" Dr.
80793	1-3/16"	12 Pt.	Std. SAE Socket	1/2" Dr.
80794	1-1/4"	12 Pt.	Std. SAE Socket	1/2" Dr.
80680	1-1/2"	12 Pt.	Std. SAE Socket	1/2" Dr.
80750	15 mm	12 Pt.	Std. Metric Socket	1/2" Dr.
80751	16 mm	12 Pt.	Std. Metric Socket	1/2" Dr.
80752	17 mm	12 Pt.	Std. Metric Socket	1/2" Dr.
80753	18 mm	12 Pt.	Std. Metric Socket	1/2" Dr.
80754	19 mm	12 Pt.	Std. Metric Socket	1/2" Dr.
80756	21 mm	12 Pt.	Std. Metric Socket	1/2" Dr.

RATCHETS, SOCKETS & DRIVE TOOLS

MULTI DRIVE SETS

80933 - Continued

Item No.	Description		
80757	22 mm	12 Pt.	Std. Metric Socket 1/2" Dr.
80759	24 mm	12 Pt.	Std. Metric Socket 1/2" Dr.
80811	25 mm	12 Pt.	Std. Metric Socket 1/2" Dr.
80812	27 mm	12 Pt.	Std. Metric Socket 1/2" Dr.
80682	28 mm	13 Pt.	Std. Metric Socket 1/2" Dr.
80813	30 mm	12 Pt.	Std. Metric Socket 1/2" Dr.
80814	32 mm	12 Pt.	Std. Metric Socket 1/2" Dr.
81309	Quick-Release Teardrop Ratchet		1/2" Dr.
81340	3" Extension		
81650	1/4"	12 Pt.	Non-Ratcheting Combination Wrench
81652	5/16"	12 Pt.	Non-Ratcheting Combination Wrench
81653	11/32"	12 Pt.	Non-Ratcheting Combination Wrench
81654	3/8"	12 Pt.	Non-Ratcheting Combination Wrench
81655	7/16"	12 Pt.	Non-Ratcheting Combination Wrench
81656	1/2"	12 Pt.	Non-Ratcheting Combination Wrench
81657	9/16"	12 Pt.	Non-Ratcheting Combination Wrench
81658	5/8"	12 Pt.	Non-Ratcheting Combination Wrench
81659	11/16"	12 Pt.	Non-Ratcheting Combination Wrench
81660	3/4"	12 Pt.	Non-Ratcheting Combination Wrench
81737	7 mm	12 Pt.	Non-Ratcheting Combination Wrench
81665	8 mm	12 Pt.	Non-Ratcheting Combination Wrench
81666	9 mm	12 Pt.	Non-Ratcheting Combination Wrench
81667	10 mm	12 Pt.	Non-Ratcheting Combination Wrench
81668	11 mm	12 Pt.	Non-Ratcheting Combination Wrench
81669	12 mm	12 Pt.	Non-Ratcheting Combination Wrench
81670	13 mm	12 Pt.	Non-Ratcheting Combination Wrench
81671	14 mm	12 Pt.	Non-Ratcheting Combination Wrench
81672	15 mm	12 Pt.	Non-Ratcheting Combination Wrench
56603G	13 Pc. SAE Hex Key		
56606G	9 Pc. Metric Hex Key		
	#1	Bit Phillips	
	#2	Bit Phillips	
	#3	Bit Phillips	
	4 mm	Bit Slotted	
	5 mm	Bit Slotted	
	6 mm	Bit Slotted	
	T40	Bit Torx®	
	T45	Bit Torx®	
	T50	Bit Torx®	
	3/16"	Nut Driver Bit	

Item No.	Description	
	1/4"	Nut Driver Bit
	5/16"	Nut Driver Bit
	11/32"	Nut Driver Bit
	3/8"	Nut Driver Bit
	7/16"	Nut Driver Bit
	1/2"	Nut Driver Bit
	5 mm	Nut Driver Bit
	6 mm	Nut Driver Bit
	7 mm	Nut Driver Bit
	8 mm	Nut Driver Bit
	9 mm	Nut Driver Bit
	10 mm	Nut Driver Bit
	11 mm	Nut Driver Bit

MULTI DRIVESETS
RATCHETS, SOCKETS & DRIVE TOOLS

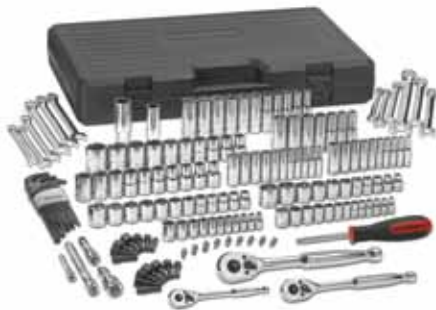

80932 - 165 Pc. SAE/METRIC 6 & 12 Pt. Mechanics Tool Set MULTI DRIVE

RATCHETS, SOCKETS & DRIVE TOOLS

Item No.	Description			
80104	5/32"	6 Pt.	Std. SAE Socket	1/4" Dr.
80105	3/16"	6 Pt.	Std. SAE Socket	1/4" Dr.
80106	7/32"	6 Pt.	Std. SAE Socket	1/4" Dr.
80107	1/4"	6 Pt.	Std. SAE Socket	1/4" Dr.
80108	9/32"	6 Pt.	Std. SAE Socket	1/4" Dr.
80109	5/16"	6 Pt.	Std. SAE Socket	1/4" Dr.
80110	11/32"	6 Pt.	Std. SAE Socket	1/4" Dr.
80111	3/8"	6 Pt.	Std. SAE Socket	1/4" Dr.
80112	7/16"	6 Pt.	Std. SAE Socket	1/4" Dr.
80113	1/2"	6 Pt.	Std. SAE Socket	1/4" Dr.
80114	9/16"	6 Pt.	Std. SAE Socket	1/4" Dr.
80125	4 mm	6 Pt.	Std. Metric Socket	1/4" Dr.
80126	5 mm	6 Pt.	Std. Metric Socket	1/4" Dr.
80127	5.5 mm	6 Pt.	Std. Metric Socket	1/4" Dr.
80128	6 mm	6 Pt.	Std. Metric Socket	1/4" Dr.
80129	7 mm	6 Pt.	Std. Metric Socket	1/4" Dr.
80130	8 mm	6 Pt.	Std. Metric Socket	1/4" Dr.
80131	9 mm	6 Pt.	Std. Metric Socket	1/4" Dr.
80132	10 mm	6 Pt.	Std. Metric Socket	1/4" Dr.
80133	11 mm	6 Pt.	Std. Metric Socket	1/4" Dr.
80134	12 mm	6 Pt.	Std. Metric Socket	1/4" Dr.
80135	13 mm	6 Pt.	Std. Metric Socket	1/4" Dr.
80136	14 mm	6 Pt.	Std. Metric Socket	1/4" Dr.
80137	15 mm	6 Pt.	Std. Metric Socket	1/4" Dr.
80115	3/16"	6 Pt.	Deep SAE Socket	1/4" Dr.
80116	7/32"	6 Pt.	Deep SAE Socket	1/4" Dr.
80117	1/4"	6 Pt.	Deep SAE Socket	1/4" Dr.
80118	9/32"	6 Pt.	Deep SAE Socket	1/4" Dr.
80119	5/16"	6 Pt.	Deep SAE Socket	1/4" Dr.
80120	11/32"	6 Pt.	Deep SAE Socket	1/4" Dr.
80121	3/8"	6 Pt.	Deep SAE Socket	1/4" Dr.
80122	7/16"	6 Pt.	Deep SAE Socket	1/4" Dr.
80123	1/2"	6 Pt.	Deep SAE Socket	1/4" Dr.

Item No.	Description			
80124	9/16"	6 Pt.	Deep SAE Socket	1/4" Dr.
80138	4 mm	6 Pt.	Deep Metric Socket	1/4" Dr.
80139	5 mm	6 Pt.	Deep Metric Socket	1/4" Dr.
80141	6 mm	6 Pt.	Deep Metric Socket	1/4" Dr.
80142	7 mm	6 Pt.	Deep Metric Socket	1/4" Dr.
80143	8 mm	6 Pt.	Deep Metric Socket	1/4" Dr.
80144	9 mm	6 Pt.	Deep Metric Socket	1/4" Dr.
80145	10 mm	6 Pt.	Deep Metric Socket	1/4" Dr.
80146	11 mm	6 Pt.	Deep Metric Socket	1/4" Dr.
80147	12 mm	6 Pt.	Deep Metric Socket	1/4" Dr.
80148	13 mm	6 Pt.	Deep Metric Socket	1/4" Dr.
80149	14 mm	6 Pt.	Deep Metric Socket	1/4" Dr.
81014	Quick-Release Teardrop Ratchet			1/4" Dr.
81113	3" Extension			1/4" Dr.
80480	1/4" Bit Holder Socket			1/4" Dr.
81128	Spinner Handle			1/4" Dr.
80350	1/4"	6 Pt.	Std. SAE Socket	3/8" Dr.
80351	5/16"	6 Pt.	Std. SAE Socket	3/8" Dr.
80352	3/8"	6 Pt.	Std. SAE Socket	3/8" Dr.
80353	7/16"	6 Pt.	Std. SAE Socket	3/8" Dr.
80354	1/2"	6 Pt.	Std. SAE Socket	3/8" Dr.
80355	9/16"	6 Pt.	Std. SAE Socket	3/8" Dr.
80356	5/8"	6 Pt.	Std. SAE Socket	3/8" Dr.
80357	11/16"	6 Pt.	Std. SAE Socket	3/8" Dr.
80358	3/4"	6 Pt.	Std. SAE Socket	3/8" Dr.
80359	13/16"	6 Pt.	Std. SAE Socket	3/8" Dr.
80360	7/8"	6 Pt.	Std. SAE Socket	3/8" Dr.
80377	9 mm	6 Pt.	Std. Metric Socket	3/8" Dr.
80378	10 mm	6 Pt.	Std. Metric Socket	3/8" Dr.
80379	11 mm	6 Pt.	Std. Metric Socket	3/8" Dr.
80380	12 mm	6 Pt.	Std. Metric Socket	3/8" Dr.
80381	13 mm	6 Pt.	Std. Metric Socket	3/8" Dr.
80382	14 mm	6 Pt.	Std. Metric Socket	3/8" Dr.
80383	15 mm	6 Pt.	Std. Metric Socket	3/8" Dr.
80384	16 mm	6 Pt.	Std. Metric Socket	3/8" Dr.
80385	17 mm	6 Pt.	Std. Metric Socket	3/8" Dr.
80386	18 mm	6 Pt.	Std. Metric Socket	3/8" Dr.
80387	19 mm	6 Pt.	Std. Metric Socket	3/8" Dr.
80330	20 mm	6 Pt.	Std. Metric Socket	3/8" Dr.

80932 - Continued

Item No.	Description		
80365	3/8"	6 Pt.	Deep SAE Socket 3/8" Dr.
80366	1/4"	6 Pt.	Deep SAE Socket 3/8" Dr.
80367	7/16"	6 Pt.	Deep SAE Socket 3/8" Dr.
80368	1/2"	6 Pt.	Deep SAE Socket 3/8" Dr.
80369	9/16"	6 Pt.	Deep SAE Socket 3/8" Dr.
80370	5/8"	6 Pt.	Deep SAE Socket 3/8" Dr.
80371	11/16"	6 Pt.	Deep SAE Socket 3/8" Dr.
80391	9 mm	6 Pt.	Deep Metric Socket 3/8" Dr.
80392	10 mm	6 Pt.	Deep Metric Socket 3/8" Dr.
80393	11 mm	6 Pt.	Deep Metric Socket 3/8" Dr.
80394	12 mm	6 Pt.	Deep Metric Socket 3/8" Dr.
80395	13 mm	6 Pt.	Deep Metric Socket 3/8" Dr.
80396	14 mm	6 Pt.	Deep Metric Socket 3/8" Dr.
80397	15 mm	6 Pt.	Deep Metric Socket 3/8" Dr.
80398	16 mm	6 Pt.	Deep Metric Socket 3/8" Dr.
80399	17 mm	6 Pt.	Deep Metric Socket 3/8" Dr.
80400	18 mm	6 Pt.	Deep Metric Socket 3/8" Dr.
80401	19 mm	6 Pt.	Deep Metric Socket 3/8" Dr.
81218	Quick-Release Teardrop Ratchet		3/8" Dr.
81241	3" Extension		3/8" Dr.
81242	6" Extension		3/8" Dr.
80402	5/8"	Spark Plug Socket	3/8" Dr.
80403	13/16"	Spark Plug Socket	3/8" Dr.
80602	7/16"	6 Pt. Std. SAE Socket	1/2" Dr.
80603	1/2"	6 Pt. Std. SAE Socket	1/2" Dr.
80604	9/16"	6 Pt. Std. SAE Socket	1/2" Dr.
80605	5/8"	6 Pt. Std. SAE Socket	1/2" Dr.
80606	11/16"	6 Pt. Std. SAE Socket	1/2" Dr.
80607	3/4"	6 Pt. Std. SAE Socket	1/2" Dr.
80608	13/16"	6 Pt. Std. SAE Socket	1/2" Dr.
80609	7/8"	6 Pt. Std. SAE Socket	1/2" Dr.
80610	15/16"	6 Pt. Std. SAE Socket	1/2" Dr.
80611	1"	6 Pt. Std. SAE Socket	1/2" Dr.
80622	10 mm	6 Pt. Std. Metric Socket	1/2" Dr.
80623	11 mm	6 Pt. Std. Metric Socket	1/2" Dr.
80624	12 mm	6 Pt. Std. Metric Socket	1/2" Dr.
80625	13 mm	6 Pt. Std. Metric Socket	1/2" Dr.
80626	14 mm	6 Pt. Std. Metric Socket	1/2" Dr.
80627	15 mm	6 Pt. Std. Metric Socket	1/2" Dr.
80628	16 mm	6 Pt. Std. Metric Socket	1/2" Dr.
80629	17 mm	6 Pt. Std. Metric Socket	1/2" Dr.

Item No.	Description		
80630	18 mm	6 Pt. Std. Metric Socket	1/2" Dr.
80631	19 mm	6 Pt. Std. Metric Socket	1/2" Dr.
81309	Quick-Release Teardrop Ratchet		1/2" Dr.
81340	3" Extension		1/2" Dr.
81652	5/16"	12 Pt. Non-Ratcheting Combination Wrench	
81654	3/8"	12 Pt. Non-Ratcheting Combination Wrench	
81655	7/16"	12 Pt. Non-Ratcheting Combination Wrench	
81656	1/2"	12 Pt. Non-Ratcheting Combination Wrench	
81657	9/16"	12 Pt. Non-Ratcheting Combination Wrench	
81660	3/4"	12 Pt. Non-Ratcheting Combination Wrench	
81666	9 mm	12 Pt. Non-Ratcheting Combination Wrench	
81667	10 mm	12 Pt. Non-Ratcheting Combination Wrench	
81669	12 mm	12 Pt. Non-Ratcheting Combination Wrench	
81670	13 mm	12 Pt. Non-Ratcheting Combination Wrench	
81671	14 mm	12 Pt. Non-Ratcheting Combination Wrench	
81672	15 mm	12 Pt. Non-Ratcheting Combination Wrench	
56603G	13 Pc SAE Hex Key		
	#1	Bit Phillips	
	#2	Bit Phillips	
	#3	Bit Phillips	
	4mm	Bit Slotted	
	5mm	Bit Slotted	
	6mm	Bit Slotted	
	T40	Bit Torx®	
	T45	Bit Torx®	
	T50	Bit Torx®	
	3/16"	Nut Driver Bit	
	1/4"	Nut Driver Bit	
	5/16"	Nut Driver Bit	
	11/32"	Nut Driver Bit	
	3/8"	Nut Driver Bit	
	7/16"	Nut Driver Bit	
	1/2"	Nut Driver Bit	
	5 mm	Nut Driver Bit	
	6 mm	Nut Driver Bit	
	7 mm	Nut Driver Bit	
	8 mm	Nut Driver Bit	
	9 mm	Nut Driver Bit	
	10 mm	Nut Driver Bit	
	11 mm	Nut Driver Bit	

MULTI DRIVESETS
RATCHETS, SOCKETS & DRIVE TOOLS



80931 - 141 Pc. SAE/METRIC 6 & 12 Pt. Mechanics Tool Set MULTI DRIVE

Item No.	Description	
80104	5/32"	6 Pt. Std. SAE Socket 1/4" Dr.
80105	3/16"	6 Pt. Std. SAE Socket 1/4" Dr.
80106	7/32"	6 Pt. Std. SAE Socket 1/4" Dr.
80107	1/4"	6 Pt. Std. SAE Socket 1/4" Dr.
80108	9/32"	6 Pt. Std. SAE Socket 1/4" Dr.
80109	5/16"	6 Pt. Std. SAE Socket 1/4" Dr.
80110	11/32"	6 Pt. Std. SAE Socket 1/4" Dr.
80111	3/8"	6 Pt. Std. SAE Socket 1/4" Dr.
80112	7/16"	6 Pt. Std. SAE Socket 1/4" Dr.
80113	1/2"	6 Pt. Std. SAE Socket 1/4" Dr.
80125	4 mm	6 Pt. Std. Metric Socket 1/4" Dr.
80126	5 mm	6 Pt. Std. Metric Socket 1/4" Dr.
80127	5.5 mm	6 Pt. Std. Metric Socket 1/4" Dr.
80128	6 mm	6 Pt. Std. Metric Socket 1/4" Dr.
80129	7 mm	6 Pt. Std. Metric Socket 1/4" Dr.
80130	8 mm	6 Pt. Std. Metric Socket 1/4" Dr.
80131	9 mm	6 Pt. Std. Metric Socket 1/4" Dr.
80132	10 mm	6 Pt. Std. Metric Socket 1/4" Dr.
80133	11 mm	6 Pt. Std. Metric Socket 1/4" Dr.
80134	12 mm	6 Pt. Std. Metric Socket 1/4" Dr.
80135	13 mm	6 Pt. Std. Metric Socket 1/4" Dr.
80117	1/4"	6 Pt. Deep SAE Socket 1/4" Dr.
80118	9/32"	6 Pt. Deep SAE Socket 1/4" Dr.
80119	5/16"	6 Pt. Deep SAE Socket 1/4" Dr.
80120	11/32"	6 Pt. Deep SAE Socket 1/4" Dr.

Item No.	Description	
80121	3/8"	6 Pt. Deep SAE Socket 1/4" Dr.
80122	7/16"	6 Pt. Deep SAE Socket 1/4" Dr.
80123	1/2"	6 Pt. Deep SAE Socket 1/4" Dr.
80142	7 mm	6 Pt. Deep Metric Socket 1/4" Dr.
80143	8 mm	6 Pt. Deep Metric Socket 1/4" Dr.
80144	9 mm	6 Pt. Deep Metric Socket 1/4" Dr.
80145	10 mm	6 Pt. Deep Metric Socket 1/4" Dr.
80146	11 mm	6 Pt. Deep Metric Socket 1/4" Dr.
80147	12 mm	6 Pt. Deep Metric Socket 1/4" Dr.
80148	13 mm	6 Pt. Deep Metric Socket 1/4" Dr.
81014	Quick-Release Teardrop Ratchet 1/4" Dr.	
81113	3" Extension 1/4" Dr.	
80480	1/4"	Bit Holder Socket 1/4" Dr.
80352	3/8"	6 Pt. Std. SAE Socket 3/8" Dr.
80353	7/16"	6 Pt. Std. SAE Socket 3/8" Dr.
80354	1/2"	6 Pt. Std. SAE Socket 3/8" Dr.
80355	9/16"	6 Pt. Std. SAE Socket 3/8" Dr.
80356	5/8"	6 Pt. Std. SAE Socket 3/8" Dr.
80357	11/16"	6 Pt. Std. SAE Socket 3/8" Dr.
80358	3/4"	6 Pt. Std. SAE Socket 3/8" Dr.
80378	10 mm	6 Pt. Std. Metric Socket 3/8" Dr.
80379	11 mm	6 Pt. Std. Metric Socket 3/8" Dr.
80380	12 mm	6 Pt. Std. Metric Socket 3/8" Dr.
80381	13 mm	6 Pt. Std. Metric Socket 3/8" Dr.
80382	14 mm	6 Pt. Std. Metric Socket 3/8" Dr.
80383	15 mm	6 Pt. Std. Metric Socket 3/8" Dr.
80384	16 mm	6 Pt. Std. Metric Socket 3/8" Dr.
80385	17 mm	6 Pt. Std. Metric Socket 3/8" Dr.
80386	18 mm	6 Pt. Std. Metric Socket 3/8" Dr.
80387	19 mm	6 Pt. Std. Metric Socket 3/8" Dr.
80365	3/8"	6 Pt. Deep SAE Socket 3/8" Dr.
80366	1/4"	6 Pt. Deep SAE Socket 3/8" Dr.
80367	7/16"	6 Pt. Deep SAE Socket 3/8" Dr.
80368	1/2"	6 Pt. Deep SAE Socket 3/8" Dr.
80369	9/16"	6 Pt. Deep SAE Socket 3/8" Dr.
80370	5/8"	6 Pt. Deep SAE Socket 3/8" Dr.
80371	11/16"	6 Pt. Deep SAE Socket 3/8" Dr.

80931 - Continued

Item No.	Description		
80392	10 mm	6 Pt.	Deep Metric Socket 3/8" Dr.
80393	11 mm	6 Pt.	Deep Metric Socket 3/8" Dr.
80394	12 mm	6 Pt.	Deep Metric Socket 3/8" Dr.
80395	13 mm	6 Pt.	Deep Metric Socket 3/8" Dr.
80396	14 mm	6 Pt.	Deep Metric Socket 3/8" Dr.
80397	15 mm	6 Pt.	Deep Metric Socket 3/8" Dr.
80398	16 mm	6 Pt.	Deep Metric Socket 3/8" Dr.
80399	17 mm	6 Pt.	Deep Metric Socket 3/8" Dr.
80400	18 mm	6 Pt.	Deep Metric Socket 3/8" Dr.
80401	19 mm	6 Pt.	Deep Metric Socket 3/8" Dr.
80498	3/8"	12 Pt.	Std. SAE Socket 3/8" Dr.
80499	7/16"	12 Pt.	Std. SAE Socket 3/8" Dr.
80500	1/2"	12 Pt.	Std. SAE Socket 3/8" Dr.
80501	9/16"	12 Pt.	Std. SAE Socket 3/8" Dr.
80502	5/8"	12 Pt.	Std. SAE Socket 3/8" Dr.
80503	11/16"	12 Pt.	Std. SAE Socket 3/8" Dr.
80504	3/4"	12 Pt.	Std. SAE Socket 3/8" Dr.
80489	13 mm	12 Pt.	Std. Metric Socket 3/8" Dr.
80490	14 mm	12 Pt.	Std. Metric Socket 3/8" Dr.
80491	15 mm	12 Pt.	Std. Metric Socket 3/8" Dr.
80492	16 mm	12 Pt.	Std. Metric Socket 3/8" Dr.
80493	17 mm	12 Pt.	Std. Metric Socket 3/8" Dr.
80494	18 mm	12 Pt.	Std. Metric Socket 3/8" Dr.
80495	19 mm	12 Pt.	Std. Metric Socket 3/8" Dr.
81218	Quick-Release Teardrop Ratchet		3/8" Dr.
81242	6" Extension		3/8" Dr.
80402	5/8"	Spark Plug Socket	3/8" Dr.
80764	11/16"	12 Pt. Std. SAE Socket	1/2" Dr.
80765	3/4"	12 Pt. Std. SAE Socket	1/2" Dr.
80766	13/16"	12 Pt. Std. SAE Socket	1/2" Dr.
80767	7/8"	12 Pt. Std. SAE Socket	1/2" Dr.
80768	15/16"	12 Pt. Std. SAE Socket	1/2" Dr.
80769	1"	12 Pt. Std. SAE Socket	1/2" Dr.
80750	15 mm	12 Pt. Std. Metric Socket	1/2" Dr.
80751	16 mm	12 Pt. Std. Metric Socket	1/2" Dr.
80752	17 mm	12 Pt. Std. Metric Socket	1/2" Dr.
80753	18 mm	12 Pt. Std. Metric Socket	1/2" Dr.
80754	19 mm	12 Pt. Std. Metric Socket	1/2" Dr.
80756	21 mm	12 Pt. Std. Metric Socket	1/2" Dr.
81309	1/2" Quick Release Teardrop Ratchet		

Item No.	Description	
81340	3" Extension	1/2" Dr.
81794	10x12mm	Double Open End Wrench
81796	12x14mm	Double Open End Wrench
81799	3/8"x 7/16"	Double Open End Wrench
81801	1/2"x 9/16"	Double Open End Wrench
56603G	13 Pc. SAE Hex Key Set	
	#1	Bit Phillips
	#2	Bit Phillips
	#3	Bit Phillips
	4mm	Bit Slotted
	5mm	Bit Slotted
	6mm	Bit Slotted
	T40	Bit Torx®
	T45	Bit Torx®
	T50	Bit Torx®
	3/16"	Nut Driver Bit
	1/4"	Nut Driver Bit
	5/16"	Nut Driver Bit
	11/32"	Nut Driver Bit
	3/8"	Nut Driver Bit
	7/16"	Nut Driver Bit
	1/2"	Nut Driver Bit
	5 mm	Nut Driver Bit
	6 mm	Nut Driver Bit
	7 mm	Nut Driver Bit
	8 mm	Nut Driver Bit
	9 mm	Nut Driver Bit
	10 mm	Nut Driver Bit
	11 mm	Nut Driver Bit

MULTI DRIVESETS
RATCHETS, SOCKETS & DRIVE TOOLS



83001 - 118 Pc. SAE/METRIC 6 & 12 Pt. Standard Socket Set MULTI DRIVE

Item No.	Description			
80105	3/16"	6 Pt.	Std. SAE Socket	1/4" Dr.
80106	7/32"	6 Pt.	Std. SAE Socket	1/4" Dr.
80107	1/4"	6 Pt.	Std. SAE Socket	1/4" Dr.
80108	9/32"	6 Pt.	Std. SAE Socket	1/4" Dr.
80109	5/16"	6 Pt.	Std. SAE Socket	1/4" Dr.
80110	11/32"	6 Pt.	Std. SAE Socket	1/4" Dr.
80111	3/8"	6 Pt.	Std. SAE Socket	1/4" Dr.
80112	7/16"	6 Pt.	Std. SAE Socket	1/4" Dr.
80113	1/2"	6 Pt.	Std. SAE Socket	1/4" Dr.
80114	9/16"	6 Pt.	Std. SAE Socket	1/4" Dr.
80117	1/4"	6 Pt.	Deep SAE Socket	1/4" Dr.
80118	9/32"	6 Pt.	Deep SAE Socket	1/4" Dr.
80119	5/16"	6 Pt.	Deep SAE Socket	1/4" Dr.
80120	11/32"	6 Pt.	Deep SAE Socket	1/4" Dr.
80121	3/8"	6 Pt.	Deep SAE Socket	1/4" Dr.
80122	7/16"	6 Pt.	Deep SAE Socket	1/4" Dr.
80123	1/2"	6 Pt.	Deep SAE Socket	1/4" Dr.
80125	4 mm	6 Pt.	Torx® Tamper-Proof Bit Socket	1/4" Dr.
80126	5 mm	6 Pt.	Std. Metric Socket	1/4" Dr.
80128	6 mm	6 Pt.	Std. Metric Socket	1/4" Dr.
80129	7 mm	6 Pt.	Std. Metric Socket	1/4" Dr.
80130	8 mm	6 Pt.	Std. SAE Socket	1/4" Dr.
80131	9 mm	6 Pt.	Std. Metric Socket	1/4" Dr.

Item No.	Description			
80132	10 mm	6 Pt.	Std. Metric Socket	1/4" Dr.
80133	11 mm	6 Pt.	Std. Metric Socket	1/4" Dr.
80134	12 mm	6 Pt.	Std. Metric Socket	1/4" Dr.
80135	13 mm	6 Pt.	Std. Metric Socket	1/4" Dr.
80142	7 mm	6 Pt.	Deep Metric Socket	1/4" Dr.
80143	8 mm	6 Pt.	Deep Metric Socket	1/4" Dr.
80144	9 mm	6 Pt.	Deep SAE Socket	1/4" Dr.
80145	10 mm	6 Pt.	Deep Metric Socket	1/4" Dr.
80146	11 mm	6 Pt.	Deep Metric Socket	1/4" Dr.
80147	12 mm	6 Pt.	Deep Metric Socket	1/4" Dr.
80148	13 mm	6 Pt.	Deep Metric Socket	1/4" Dr.
80377	9 mm	6 Pt.	Std. Metric Socket	3/8" Dr.
80378	10 mm	6 Pt.	Std. Metric Socket	3/8" Dr.
80379	11 mm	6 Pt.	Std. Metric Socket	3/8" Dr.
80380	12 mm	6 Pt.	Std. Metric Socket	3/8" Dr.
80381	13 mm	6 Pt.	Std. Metric Socket	3/8" Dr.
80382	14 mm	6 Pt.	Std. Metric Socket	3/8" Dr.
80383	15 mm	6 Pt.	Std. Metric Socket	3/8" Dr.
80385	17 mm	6 Pt.	Std. Metric Socket	3/8" Dr.
80387	19 mm	6 Pt.	Std. Metric Socket	3/8" Dr.
80392	10 mm	6 Pt.	Deep Metric Socket	3/8" Dr.
80394	12 mm	6 Pt.	Deep Metric Socket	3/8" Dr.
80395	13 mm	6 Pt.	Deep Metric Socket	3/8" Dr.
80396	14 mm	6 Pt.	Deep Metric Socket	3/8" Dr.
80397	15 mm	6 Pt.	Deep SAE Socket	3/8" Dr.
80398	16 mm	6 Pt.	Deep Metric Socket	3/8" Dr.
80399	17 mm	6 Pt.	Deep Metric Socket	3/8" Dr.
80210	3/16"	12 Pt.	Std. SAE Socket	1/4" Dr.
80211	7/32"	12 Pt.	Std. SAE Socket	1/4" Dr.
80212	1/4"	12 Pt.	Std. SAE Socket	1/4" Dr.
80213	9/32"	12 Pt.	Std. SAE Socket	1/4" Dr.
80214	5/16"	12 Pt.	Std. SAE Socket	1/4" Dr.
80215	11/32"	12 Pt.	Std. SAE Socket	1/4" Dr.
80216	3/8"	12 Pt.	Std. SAE Socket	1/4" Dr.
80217	7/16"	12 Pt.	Std. SAE Socket	1/4" Dr.
80218	1/2"	12 Pt.	Std. SAE Socket	1/4" Dr.
80485	9 mm	12 Pt.	Std. Metric Socket	3/8" Dr.
80486	10 mm	12 Pt.	Std. Metric Socket	3/8" Dr.

83001 - Continued

Item No.	Description			
80487	11 mm	12 Pt.	Std. Metric Socket	3/8" Dr.
80488	12 mm	12 Pt.	Std. Metric Socket	3/8" Dr.
80489	13 mm	12 Pt.	Std. Metric Socket	3/8" Dr.
80490	14 mm	12 Pt.	Std. Metric Socket	3/8" Dr.
80491	15 mm	12 Pt.	Std. Metric Socket	3/8" Dr.
80492	16 mm	12 Pt.	Std. Metric Socket	3/8" Dr.
80493	17 mm	12 Pt.	Std. Metric Socket	3/8" Dr.
80494	18 mm	12 Pt.	Std. Metric Socket	3/8" Dr.
80495	19 mm	12 Pt.	Std. Metric Socket	3/8" Dr.
80498	3/8"	12 Pt.	Std. SAE Socket	3/8" Dr.
80499	7/16"	12 Pt.	Std. SAE Socket	1/4" Dr.
80500	1/2"	12 Pt.	Std. SAE Socket	3/8" Dr.
80501	9/16"	12 Pt.	Std. SAE Socket	3/8" Dr.
80502	5/8"	12 Pt.	Std. SAE Socket	3/8" Dr.
80503	11/16"	12 Pt.	Std. SAE Socket	3/8" Dr.
80504	3/4"	12 Pt.	Std. SAE Socket	3/8" Dr.
80505	13/16"	12 Pt.	Std. SAE Socket	3/8" Dr.
80510	5/16"	12 Pt.	Deep SAE Socket	3/8" Dr.
80511	3/8"	12 Pt.	Deep SAE Socket	3/8" Dr.
80512	1/4"	12 Pt.	Deep SAE Socket	3/8" Dr.
80513	7/16"	12 Pt.	Std. SAE Socket	3/8" Dr.
80514	1/2"	12 Pt.	Deep SAE Socket	3/8" Dr.
80515	9/16"	12 Pt.	Deep SAE Socket	3/8" Dr.
80516	5/8"	12 Pt.	Deep SAE Socket	3/8" Dr.
80772	7/16"	12 Pt.	Deep SAE Socket	1/4" Dr.
80773	1/2"	12 Pt.	Deep SAE Socket	1/4" Dr.
80774	9/16"	12 Pt.	Deep SAE Socket	1/2" Dr.
80775	5/8"	12 Pt.	Deep SAE Socket	1/4" Dr.
80776	11/16"	12 Pt.	Deep SAE Socket	1/4" Dr.
80777	3/4"	6 Pt.	Deep SAE Socket	1/4" Dr.
80778	13/16"	12 Pt.	Deep SAE Socket	1/2" Dr.
80402	5/8"	Spark Plug Socket		3/8" Dr.
80178	T-7	Torx® Tamper-Proof Bit Socket		1/4" Dr.
80179	T-8	Torx® Tamper-Proof Bit Socket		1/4" Dr.
80180	T-10	Torx® Tamper-Proof Bit Socket		1/4" Dr.
80181	T-15	Torx® Tamper-Proof Bit Socket		1/4" Dr.
80182	T-20	Torx® Tamper-Proof Bit Socket		1/4" Dr.
80471	T-10	Torx® Tamper-Proof Bit Socket		3/8" Dr.
80472	1/4"	Std. SAE Socket		1/4" Dr.
80473	1/4"	Bit Holder Socket		1/4" Dr.

Item No.	Description			
80474	1/4"	Bit Holder Socket		1/4" Dr.
80475	1/4"	Bit Holder Socket		1/4" Dr.
80476	1/4"	Bit Holder Socket		1/4" Dr.
80480	1/4"	Bit Holder Socket		1/4" Dr.
81655	7/16"	Non-Ratcheting Combination Wrench		
81656	1/2"	Non-Ratcheting Combination Wrench		
81657	9/16"	Non-Ratcheting Combination Wrench		
81675	18 mm	Non-Ratcheting Combination Wrench		
81676	19 mm	Non-Ratcheting Combination Wrench		
81119	2"	Wobble Socket		1/4" Dr.
81345	5"	Wobble Socket		1/2" Dr.
81241	3"	Extension Socket		3/8" Dr.
81242	6"	Extension		3/8" Dr.
81128	Spinner Handle			1/4" Dr.
81011	Full Polish Teardrop Ratchet			1/4" Dr.
81211	Full Polish Teardrop Ratchet			3/8" Dr.
81304	Full Polish Teardrop Ratchet			1/4" Dr.
83001BM	Replacement Blow Mold Case			

MULTI DRIVESETS
RATCHETS, SOCKETS & DRIVE TOOLS



80930 - 88 Pc. SAE/METRIC 6 & 12 Pt. Mechanics Tool Set MULTI DRIVE

Item No.	Description			
80104	5/32"	6 Pt.	Std. SAE Socket	1/4" Dr.
80105	3/16"	6 Pt.	Std. SAE Socket	1/4" Dr.
80106	7/32"	6 Pt.	Std. SAE Socket	1/4" Dr.
80107	1/4"	6 Pt.	Std. SAE Socket	1/4" Dr.
80108	9/32"	6 Pt.	Std. SAE Socket	1/4" Dr.
80109	5/16"	6 Pt.	Std. SAE Socket	1/4" Dr.
80110	11/32"	6 Pt.	Std. SAE Socket	1/4" Dr.
80111	3/8"	6 Pt.	Std. SAE Socket	1/4" Dr.
80112	7/16"	6 Pt.	Std. SAE Socket	1/4" Dr.
80113	1/2"	6 Pt.	Std. SAE Socket	1/4" Dr.
80114	9/16"	6 Pt.	Std. SAE Socket	1/4" Dr.
80125	4 mm	6 Pt.	Std. Metric Socket	1/4" Dr.
80126	5 mm	6 Pt.	Std. Metric Socket	1/4" Dr.
80127	5.5 mm	6 Pt.	Std. Metric Socket	1/4" Dr.
80128	6 mm	6 Pt.	Std. Metric Socket	1/4" Dr.
80129	7 mm	6 Pt.	Std. Metric Socket	1/4" Dr.
80130	8 mm	6 Pt.	Std. Metric Socket	1/4" Dr.
80131	9 mm	6 Pt.	Std. Metric Socket	1/4" Dr.
80132	10 mm	6 Pt.	Std. Metric Socket	1/4" Dr.
80133	11 mm	6 Pt.	Std. Metric Socket	1/4" Dr.
80134	12 mm	6 Pt.	Std. Metric Socket	1/4" Dr.
80135	13 mm	6 Pt.	Std. Metric Socket	1/4" Dr.
80136	14 mm	6 Pt.	Std. Metric Socket	1/4" Dr.
80480	1/4"		Bit Holder Socket	1/4" Dr.
80496	1/4"	12 Pt.	Std. SAE Socket	3/8" Dr.
80497	5/16"	12 Pt.	Std. SAE Socket	3/8" Dr.

Item No.	Description			
80498	3/8"	12 Pt.	Std. SAE Socket	3/8" Dr.
80499	7/16"	12 Pt.	Std. SAE Socket	3/8" Dr.
80500	1/2"	12 Pt.	Std. SAE Socket	3/8" Dr.
80501	9/16"	12 Pt.	Std. SAE Socket	3/8" Dr.
80502	5/8"	12 Pt.	Std. SAE Socket	3/8" Dr.
80503	11/16"	12 Pt.	Std. SAE Socket	3/8" Dr.
80504	3/4"	12 Pt.	Std. SAE Socket	3/8" Dr.
80505	13/16"	12 Pt.	Std. SAE Socket	3/8" Dr.
80506	7/8"	12 Pt.	Std. SAE Socket	3/8" Dr.
80485	9 mm	12 Pt.	Std. Metric Socket	3/8" Dr.
80486	10 mm	12 Pt.	Std. Metric Socket	3/8" Dr.
80487	11 mm	12 Pt.	Std. SAE Socket	3/8" Dr.
80488	12 mm	12 Pt.	Std. Metric Socket	3/8" Dr.
80489	13 mm	12 Pt.	Std. Metric Socket	3/8" Dr.
80490	14 mm	12 Pt.	Std. Metric Socket	3/8" Dr.
80491	15 mm	12 Pt.	Std. Metric Socket	3/8" Dr.
80492	16 mm	12 Pt.	Std. Metric Socket	3/8" Dr.
80493	17 mm	12 Pt.	Std. Metric Socket	3/8" Dr.
80494	18 mm	12 Pt.	Std. Metric Socket	3/8" Dr.
80495	19 mm	12 Pt.	Std. Metric Socket	3/8" Dr.
81218	Quick-Release Teardrop Ratchet			3/8" Dr.
81128	Spinner Handle			1/4" Dr.
81241	3" Extension			3/8" Dr.
80402	5/8"		Spark Plug Socket	3/8" Dr.
81277	3/8" F x 1/4" M Adapter			3/8" Dr.
81794	10 x 12 mm	Double Open End Wrench		
81796	12 x 14 mm	Double Open End Wrench		
81799	3/8" x 7/16" Double Open End Wrench			
81801	1/2" x 9/16" Double Open End Wrench			
56603G	13 Pc. SAE Hex Key Set			
	#1	Bit Phillips		
	#2	Bit Phillips		
	#3	Bit Phillips		
	4 mm	Bit Slotted		
	5 mm	Bit Slotted		
	6 mm	Bit Slotted		

83000 - 68 Pc. SAE/METRIC 6 & 12 Pt. Standard Socket Set MULTI DRIVE



Item No.	Description			
80115	3/16"	6 Pt.	Deep SAE Socket	1/4" Dr.
80116	7/32"	6 Pt.	Deep SAE Socket	1/4" Dr.
80117	1/4"	6 Pt.	Deep SAE Socket	1/4" Dr.
80118	9/32"	6 Pt.	Deep SAE Socket	1/4" Dr.
80119	5/16"	6 Pt.	Deep SAE Socket	1/4" Dr.
80120	11/32"	6 Pt.	Deep SAE Socket	1/4" Dr.
80121	3/8"	6 Pt.	Deep SAE Socket	1/4" Dr.
80122	7/16"	6 Pt.	Deep SAE Socket	1/4" Dr.
80123	1/2"	6 Pt.	Deep SAE Socket	1/4" Dr.
80141	6 mm	6 Pt.	Deep Metric Socket	1/4" Dr.
80142	7 mm	6 Pt.	Deep SAE Socket	1/4" Dr.
80143	8 mm	6 Pt.	Deep Metric Socket	1/4" Dr.
80144	9 mm	6 Pt.	Deep Metric Socket	1/4" Dr.
80145	10 mm	6 Pt.	Deep Metric Socket	1/4" Dr.
80146	11 mm	6 Pt.	Deep Metric Socket	1/4" Dr.
80147	12 mm	6 Pt.	Deep Metric Socket	1/4" Dr.
80148	13 mm	6 Pt.	Deep Metric Socket	1/4" Dr.
80149	14 mm	6 Pt.	Deep Metric Socket	1/4" Dr.
80365	3/8"	6 Pt.	Deep SAE Socket	3/8" Dr.
80366	1/4"	6 Pt.	Deep SAE Socket	3/8" Dr.
80367	7/16"	6 Pt.	Deep SAE Socket	3/8" Dr.
80368	1/2"	6 Pt.	Deep SAE Socket	3/8" Dr.
80369	9/16"	12 Pt.	Deep SAE Socket	3/8" Dr.
80370	5/8"	6 Pt.	Deep SAE Socket	3/8" Dr.
80371	11/16"	6 Pt.	Deep SAE Socket	3/8" Dr.
80372	3/4"	6 Pt.	Deep SAE Socket	3/8" Dr.
80485	9 mm	12 Pt.	Std. Metric Socket	3/8" Dr.
80486	10 mm	12 Pt.	Std. Metric Socket	3/8" Dr.
80487	11 mm	12 Pt.	Std. Metric Socket	3/8" Dr.
80488	12 mm	12 Pt.	Std. Metric Socket	3/8" Dr.
80489	13 mm	12 Pt.	Std. Metric Socket	3/8" Dr.
80490	14 mm	12 Pt.	Std. Metric Socket	3/8" Dr.
80491	15 mm	12 Pt.	Std. Metric Socket	3/8" Dr.
80492	16 mm	12 Pt.	Std. Metric Socket	3/8" Dr.
80493	17 mm	12 Pt.	Std. Metric Socket	3/8" Dr.
80498	3/8"	12 Pt.	Std. SAE Socket	3/8" Dr.
80499	7/16"	12 Pt.	Std. SAE Socket	3/8" Dr.
80500	1/2"	12 Pt.	Std. SAE Socket	3/8" Dr.

Item No.	Description			
80501	9/16"	12 Pt.	Std. SAE Socket	3/8" Dr.
80502	5/8"	12 Pt.	Std. SAE Socket	3/8" Dr.
80503	11/16"	12 Pt.	Std. SAE Socket	3/8" Dr.
80504	3/4"	12 Pt.	Std. SAE Socket	3/8" Dr.
80505	13/16"	12 Pt.	Std. SAE Socket	3/8" Dr.
80506	7/8"	12 Pt.	Std. SAE Socket	3/8" Dr.
80197	4 mm	12 Pt.	Std. Metric Socket	1/4" Dr.
80198	5 mm	12 Pt.	Std. Metric Socket	1/4" Dr.
80200	6 mm	12 Pt.	Std. Metric Socket	1/4" Dr.
80201	7 mm	12 Pt.	Std. Metric Socket	1/4" Dr.
80202	8 mm	12 Pt.	Std. Metric Socket	1/4" Dr.
80203	9 mm	12 Pt.	Std. SAE Socket	1/4" Dr.
80204	10 mm	12 Pt.	Std. Metric Socket	1/4" Dr.
80205	11 mm	12 Pt.	Std. Metric Socket	1/4" Dr.
80206	12 mm	12 Pt.	Std. Metric Socket	1/4" Dr.
80210	3/16"	12 Pt.	Std. SAE Socket	1/4" Dr.
80211	7/32"	12 Pt.	Std. SAE Socket	1/4" Dr.
80212	1/4"	12 Pt.	Std. SAE Socket	1/4" Dr.
80213	9/32"	12 Pt.	Std. SAE Socket	1/4" Dr.
80214	5/16"	12 Pt.	Std. SAE Socket	1/4" Dr.
80215	11/32"	12 Pt.	Std. SAE Socket	1/4" Dr.
80216	3/8"	12 Pt.	Std. SAE Socket	1/4" Dr.
80217	7/16"	12 Pt.	Std. SAE Socket	1/4" Dr.
80218	1/2"	12 Pt.	Std. SAE Socket	1/4" Dr.
81101	2" Extension			1/4" Dr.
81116	6" Extension			1/4" Dr.
81241	3" Extension			3/8" Dr.
81242	6" Extension			3/8" Dr.
81011	Full Polish Teardrop Ratchet			1/4" Dr.
81211	Full Polish Teardrop Ratchet			3/8" Dr.
83000BM	Replacement Blow Mold Case			

MULTI DRIVE SETS
RATCHETS, SOCKETS & DRIVE TOOLS



80929 - 39 Pc. SAE/METRIC 6 Pt. Standard Socket Set MULTI DRIVE

Item No.	Description
80104	5/32" 6 Pt. Std. SAE Socket 1/4" Dr.
80105	3/16" 6 Pt. Std. SAE Socket 1/4" Dr.
80106	7/32" 6 Pt. Std. SAE Socket 1/4" Dr.
80107	1/4" 6 Pt. Std. SAE Socket 1/4" Dr.
80108	9/32" 6 Pt. Std. SAE Socket 1/4" Dr.
80109	5/16" 6 Pt. Std. SAE Socket 1/4" Dr.
80110	11/32" 6 Pt. Std. SAE Socket 1/4" Dr.
80111	3/8" 6 Pt. Std. SAE Socket 1/4" Dr.
80112	7/16" 6 Pt. Std. SAE Socket 1/4" Dr.
80113	1/2" 6 Pt. Std. SAE Socket 1/4" Dr.
80114	9/16" 6 Pt. Std. SAE Socket 1/4" Dr.
80125	4 mm 6 Pt. Std. Metric Socket 1/4" Dr.
80126	5 mm 6 Pt. Std. Metric Socket 1/4" Dr.
80127	5.5 mm 6 Pt. Std. Metric Socket 1/4" Dr.

Item No.	Description
80128	6 mm 6 Pt. Std. Metric Socket 1/4" Dr.
80129	7 mm 6 Pt. Std. Metric Socket 1/4" Dr.
80130	8 mm 6 Pt. Std. Metric Socket 1/4" Dr.
80131	9 mm 6 Pt. Std. Metric Socket 1/4" Dr.
80132	10 mm 6 Pt. Std. Metric Socket 1/4" Dr.
80350	1/4" 6 Pt. Std. SAE Socket 3/8" Dr.
80351	5/16" 6 Pt. Std. SAE Socket 3/8" Dr.
80352	3/8" 6 Pt. Std. SAE Socket 3/8" Dr.
80353	7/16" 6 Pt. Std. SAE Socket 3/8" Dr.
80354	1/2" 6 Pt. Std. SAE Socket 3/8" Dr.
80355	9/16" 6 Pt. Std. SAE Socket 3/8" Dr.
80356	5/8" 6 Pt. Std. SAE Socket 3/8" Dr.
80357	11/16" 6 Pt. Std. SAE Socket 3/8" Dr.
80358	3/4" 6 Pt. Std. SAE Socket 3/8" Dr.
80377	9 mm 6 Pt. Std. Metric Socket 3/8" Dr.
80378	10 mm 6 Pt. Std. Metric Socket 3/8" Dr.
80379	11 mm 6 Pt. Std. Metric Socket 3/8" Dr.
80380	12 mm 6 Pt. Std. Metric Socket 3/8" Dr.
80381	13 mm 6 Pt. Std. Metric Socket 3/8" Dr.
80382	14 mm 6 Pt. Std. Metric Socket 3/8" Dr.
80383	15 mm 6 Pt. Std. Metric Socket 3/8" Dr.
81218	Quick-Release Teardrop Ratchet 3/8" Dr.
81241	3" Extension 3/8" Dr.
80402	5/8" Spark Plug Socket 3/8" Dr.
81277	3/8" F x 1/4" Adapter 3/8" Dr.

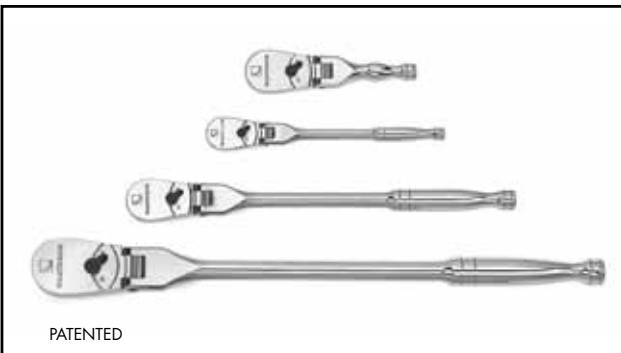

81230 - 4 Pc. Full Polish Flex Handle Ratchet Set MULTI DRIVE

Item No.	Description
81012	Full Polish Flex Teardrop Ratchet 1/4" Dr.
81215	Full Polish Flex Teardrop Ratchet 3/8" Dr.
81212	Full Polish Stubby Flex Teardrop Ratchet 3/8" Dr.
81306	Full Polish Flex Teardrop Ratchet 1/2" Dr.

• 60 tooth low profile ratchets

PATENTED

**81216 - 2 Pc. Full Polish Flex Handle Ratchet Set
MULTI DRIVE**

Item No.	Description	
81012	Full Polish Teardrop Ratchet	1/4" Dr.
81215	Full Polish Teardrop Ratchet	3/8" Dr.

- 60 tooth low profile ratchets



PATENTED

**81206 - 3 Pc. Full Polish Teardrop Ratchet Set
MULTI DRIVE**

Item No.	Description	
81011	Full Polish Teardrop Ratchet	1/4" Dr.
81211	Full Polish Teardrop Ratchet	3/8" Dr.
81304	Full Polish Teardrop Ratchet	1/2" Dr.

- 60 tooth low profile ratchets

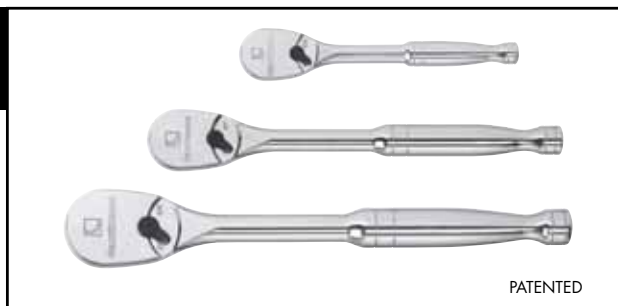

PATENTED

**81310 - 3 Pc. Quick-Release Teardrop Ratchet Set
MULTI DRIVE**

Item No.	Description	
81014	Quick-Release Teardrop Ratchet	1/4" Dr.
81218	Quick-Release Teardrop Ratchet	3/8" Dr.
81309	Quick-Release Teardrop Ratchet	1/2" Dr.

- 45 tooth standard ratchets



**81207 - 3 Pc. Cushion Grip Teardrop Ratchet Set
MULTI DRIVE**

Item No.	Description	
81007	Cushion Grip Teardrop Ratchet	1/4" Dr.
81208	Cushion Grip Teardrop Ratchet	3/8" Dr.
81303	Cushion Grip Teardrop Ratchet	1/2" Dr.

- 60 tooth low profile ratchets



PATENTED

**81203 - 3 Pc. Cushion Grip Mixed Ratchet Set
MULTI DRIVE**

Item No.	Description	
81007	Cushion Grip Flex Teardrop Ratchet	1/4" Dr.
81208	Cushion Grip Flex Teardrop Ratchet	3/8" Dr.
81210	Cushion Grip Flex Teardrop Ratchet	3/8" Dr.

- 60 tooth low profile ratchets



PATENTED



81204 - 2 Pc. Cushion Grip Flex Teardrop Ratchet Set MULTI DRIVE

Item No.	Description	
81009	Cushion Grip Flex Teardrop Ratchet	1/4" Dr.
81210	Cushion Grip Flex Teardrop Ratchet	3/8" Dr.

- 60 tooth low profile ratchets



81223 - 2 Pc. Cushion Grip Roto Ratchet Set MULTI DRIVE

Item No.	Description	
81224	Cushion Grip Roto Ratchet	1/4" Dr.
81225	Cushion Grip Roto Ratchet	3/8" Dr.

- 72 tooth ratchets



81222 - 2 Pc. Thumbwheel Ratchet Set MULTI DRIVE

Item No.	Description	
81008	Thumbwheel Ratchet	1/4" Dr.
81226	Thumbwheel Ratchet	3/8" Dr.



81205 - 10 Pc. Universal Adapter Set MULTI DRIVE

Item No.	Description	
80100	Universal Joint	1/4" Dr.
80549	Universal Joint	3/8" Dr.
80101	Impact Universal Joint	1/4" Dr.
80548	Universal Joint	3/8" Dr.
80671	Universal Joint	1/2" Dr.
81127	1/4" F x 3/8" M Adapter	1/4" Dr.
81277	3/8" F x 1/4" M Adapter	3/8" Dr.
81278	3/8" F x 1/2" M Adapter	3/8" Dr.
81354	1/2" F x 3/8" M Adapter	1/2" Dr.
81355	1/2" F x 3/4" M Adapter	1/2" Dr.



81217 - 4 Pc. Clip Rail Adapter Set MULTI DRIVE

Item No.	Description	
81127	1/4" F x 3/8" M Adapter	1/4" Dr.
81277	3/8" F x 1/4" M Adapter	3/8" Dr.
81278	3/8" F x 1/2" M Adapter	3/8" Dr.
81354	1/2" F x 3/8" M Adapter	1/2" Dr.

81231 - 3 Pc. Universal Spring Joint Set
MULTI DRIVE

Item No.	Description	
81232	Spring Universal Joint	1/4" Dr.
81233	Spring Universal Joint	3/8" Dr.
81234	Spring Universal Joint	1/2" Dr.



81235 - 9 Pc. Magnetic Drive Tool Set
MULTI DRIVE

Item No.	Description	
81255	Magnetic Universal Joint	1/4" Dr.
81256	Magnetic Universal Joint	3/8" Dr.
81257	Magnetic Universal Joint	1/2" Dr.
81258	1/4" F x 3/8" M Magnetic Extension	1/4" Dr.
81259	3/8" F x 1/4" M Magnetic Adapter	3/8" Dr.
81260	3/8" F x 1/2" M Magnetic Adapter	1/2" Dr.
81261	6" Magnetic Universal Joint	1/4" Dr.



81262	6" Magnetic Extension	3/8" Dr.
81263	6" Magnetic Extension	1/2" Dr.

81236 - 3 Pc. Magnetic Universal Joint Set
MULTI DRIVE

Item No.	Description	
81255	Magnetic Universal Joint	1/4" Dr.
81256	Magnetic Universal Joint	3/8" Dr.
81257	Magnetic Universal Joint	1/2" Dr.



81237 - 3 Pc. Magnetic Adapter Set
MULTI DRIVE

Item No.	Description	
81258	1/4" F x 3/8" M Magnetic Adapter	1/4" Dr.
81259	3/8" F x 1/4" M Magnetic Adapter	3/8" Dr.
81260	1/2" F x 3/8" M Magnetic Adapter	1/2" Dr.



81238 - 3 Pc. Magnetic Extension Bar Set
MULTI DRIVE

Item No.	Description	
81261	6" Magnetic Extension	1/4" Dr.
81262	6" Magnetic Extension	3/8" Dr.
81263	6" Magnetic Extension	1/2" Dr.



MULTI DRIVE SETS
RATCHETS, SOCKETS & DRIVE TOOLS



80300 - 51 Pc. SAE/METRIC 6 Pt. Standard & Deep Socket Set 1/4" DRIVE

Item No.	Description			
80105	3/16"	6 Pt.	Std. SAE Socket	1/4" Dr.
80106	7/32"	6 Pt.	Std. SAE Socket	1/4" Dr.
80107	1/4"	6 Pt.	Std. SAE Socket	1/4" Dr.
80108	9/32"	6 Pt.	Std. SAE Socket	1/4" Dr.
80109	5/16"	6 Pt.	Std. SAE Socket	1/4" Dr.
80110	11/32"	6 Pt.	Std. SAE Socket	1/4" Dr.
80111	3/8"	6 Pt.	Std. SAE Socket	1/4" Dr.
80112	7/16"	6 Pt.	Std. SAE Socket	1/4" Dr.
80113	1/2"	6 Pt.	Std. SAE Socket	1/4" Dr.
80114	9/16"	6 Pt.	Std. SAE Socket	1/4" Dr.
80125	4 mm	6 Pt.	Std. Metric Socket	1/4" Dr.
80126	5 mm	6 Pt.	Std. Metric Socket	1/4" Dr.
80127	5.5 mm	6 Pt.	Std. Metric Socket	1/4" Dr.
80128	6 mm	6 Pt.	Std. Metric Socket	1/4" Dr.
80129	7 mm	6 Pt.	Std. Metric Socket	1/4" Dr.
80130	8 mm	6 Pt.	Std. Metric Socket	1/4" Dr.
80131	9 mm	6 Pt.	Std. Metric Socket	1/4" Dr.
80132	10 mm	6 Pt.	Std. Metric Socket	1/4" Dr.
80133	11 mm	6 Pt.	Std. Metric Socket	1/4" Dr.
80134	12 mm	6 Pt.	Std. Metric Socket	1/4" Dr.

Item No.	Description			
80135	13 mm	6 Pt.	Std. Metric Socket	1/4" Dr.
80136	14 mm	6 Pt.	Std. Metric Socket	1/4" Dr.
80137	15 mm	6 Pt.	Std. Metric Socket	1/4" Dr.
80115	3/16"	6 Pt.	Deep SAE Socket	1/4" Dr.
80116	7/32"	6 Pt.	Deep SAE Socket	1/4" Dr.
80117	1/4"	6 Pt.	Deep SAE Socket	1/4" Dr.
80118	9/32"	6 Pt.	Deep SAE Socket	1/4" Dr.
80119	5/16"	6 Pt.	Deep SAE Socket	1/4" Dr.
80120	11/32"	6 Pt.	Deep SAE Socket	1/4" Dr.
80121	3/8"	6 Pt.	Deep SAE Socket	1/4" Dr.
80122	7/16"	6 Pt.	Deep SAE Socket	1/4" Dr.
80123	1/2"	6 Pt.	Deep SAE Socket	1/4" Dr.
80124	9/16"	6 Pt.	Deep SAE Socket	1/4" Dr.
80138	4 mm	6 Pt.	Deep Metric Socket	1/4" Dr.
80139	5 mm	6 Pt.	Deep Metric Socket	1/4" Dr.
80140	5.5 mm	6 Pt.	Deep Metric Socket	1/4" Dr.
80141	6 mm	6 Pt.	Deep Metric Socket	1/4" Dr.
80142	7 mm	6 Pt.	Deep Metric Socket	1/4" Dr.
80143	8 mm	6 Pt.	Deep Metric Socket	1/4" Dr.
80144	9 mm	6 Pt.	Deep Metric Socket	1/4" Dr.
80145	10 mm	6 Pt.	Deep Metric Socket	1/4" Dr.
80146	11 mm	6 Pt.	Deep Metric Socket	1/4" Dr.
80147	12 mm	6 Pt.	Deep Metric Socket	1/4" Dr.
80148	13 mm	6 Pt.	Deep Metric Socket	1/4" Dr.
80149	14 mm	6 Pt.	Deep Metric Socket	1/4" Dr.
80150	15 mm	6 Pt.	Deep Metric Socket	1/4" Dr.
81101	2" Extension			1/4" Dr.
81116	6" Extension			1/4" Dr.
80100	Universal Joint			1/4" Dr.
81008	Thumbwheel Ratchet			1/4" Dr.
81011	Full Polish Teardrop Ratchet			1/4" Dr.
80300BM	Replacement Blow Mold Case			1/4" Dr.

80301 - 51 Pc. SAE/METRIC 12 Pt. Standard & Deep Socket Set 1/4" DRIVE

Item No.	Description
80210	3/16" 12 Pt. Std. SAE Socket 1/4" Dr.
80211	7/32" 12 Pt. Std. SAE Socket 1/4" Dr.
80212	1/4" 12 Pt. Std. SAE Socket 1/4" Dr.
80213	9/32" 12 Pt. Std. SAE Socket 1/4" Dr.
80214	5/16" 12 Pt. Std. SAE Socket 1/4" Dr.
80215	11/32" 12 Pt. Std. SAE Socket 1/4" Dr.
80216	3/8" 12 Pt. Std. SAE Socket 1/4" Dr.
80217	7/16" 12 Pt. Std. SAE Socket 1/4" Dr.
80218	1/2" 12 Pt. Std. SAE Socket 1/4" Dr.
80219	9/16" 12 Pt. Std. SAE Socket 1/4" Dr.
80197	4 mm 12 Pt. Std. Metric Socket 1/4" Dr.
80198	5 mm 12 Pt. Std. Metric Socket 1/4" Dr.
80199	5.5 mm 12 Pt. Std. Metric Socket 1/4" Dr.
80200	6 mm 12 Pt. Std. Metric Socket 1/4" Dr.
80201	7 mm 12 Pt. Std. Metric Socket 1/4" Dr.
80202	8 mm 12 Pt. Std. Metric Socket 1/4" Dr.
80203	9 mm 12 Pt. Std. Metric Socket 1/4" Dr.
80204	10 mm 12 Pt. Std. Metric Socket 1/4" Dr.
80205	11 mm 12 Pt. Std. Metric Socket 1/4" Dr.
80206	12 mm 12 Pt. Std. Metric Socket 1/4" Dr.
80207	13 mm 12 Pt. Std. Metric Socket 1/4" Dr.
80208	14 mm 12 Pt. Std. Metric Socket 1/4" Dr.
80209	15 mm 12 Pt. Std. Metric Socket 1/4" Dr.
80220	3/16" 12 Pt. Deep SAE Socket 1/4" Dr.
80221	7/32" 12 Pt. Deep SAE Socket 1/4" Dr.
80222	1/4" 12 Pt. Deep SAE Socket 1/4" Dr.
80223	9/32" 12 Pt. Deep SAE Socket 1/4" Dr.
80224	5/16" 12 Pt. Deep SAE Socket 1/4" Dr.
80225	11/32" 12 Pt. Deep SAE Socket 1/4" Dr.
80226	3/8" 12 Pt. Deep SAE Socket 1/4" Dr.
80227	7/16" 12 Pt. Deep SAE Socket 1/4" Dr.
80228	1/2" 12 Pt. Deep SAE Socket 1/4" Dr.



Item No.	Description
80229	9/16" 12 Pt. Deep SAE Socket 1/4" Dr.
80230	4 mm 12 Pt. Deep Metric Socket 1/4" Dr.
80231	5 mm 12 Pt. Deep Metric Socket 1/4" Dr.
80232	5.5 mm 12 Pt. Deep Metric Socket 1/4" Dr.
80233	6 mm 12 Pt. Deep Metric Socket 1/4" Dr.
80234	7 mm 12 Pt. Deep Metric Socket 1/4" Dr.
80235	8 mm 12 Pt. Deep Metric Socket 1/4" Dr.
80236	9 mm 12 Pt. Deep Metric Socket 1/4" Dr.
80237	10 mm 6 Pt. Deep Metric Socket 1/4" Dr.
80238	11 mm 6 Pt. Deep Metric Socket 1/4" Dr.
80239	12 mm 6 Pt. Deep Metric Socket 1/4" Dr.
80240	13 mm 6 Pt. Deep Metric Socket 1/4" Dr.
80241	14 mm 6 Pt. Deep Metric Socket 1/4" Dr.
80242	15 mm 6 Pt. Deep Metric Socket 1/4" Dr.
81101	2" Extension 1/4" Dr.
81116	6" Extension 1/4" Dr.
80100	Universal Joint 1/4" Dr.
81008	Thumbwheel Ratchet 1/4" Dr.
81011	Full Polish Teardrop Ratchet 1/4" Dr.

1/4" DRIVE SETS
RATCHETS, SOCKETS & DRIVE TOOLS



80312 - 26 Pc. SAE 6 Pt. Standard & Deep Socket Set 1/4" DRIVE

Item No.	Description			
80104	5/32"	6 Pt.	Std. SAE Socket	1/4" Dr.
80105	3/16"	6 Pt.	Std. SAE Socket	1/4" Dr.
80106	7/32"	6 Pt.	Std. SAE Socket	1/4" Dr.
80107	1/4"	6 Pt.	Std. SAE Socket	1/4" Dr.
80108	9/32"	6 Pt.	Std. SAE Socket	1/4" Dr.
80109	5/16"	6 Pt.	Std. SAE Socket	1/4" Dr.
80110	11/32"	6 Pt.	Std. SAE Socket	1/4" Dr.
80111	3/8"	6 Pt.	Std. SAE Socket	1/4" Dr.
80112	7/16"	6 Pt.	Std. SAE Socket	1/4" Dr.
80113	1/2"	6 Pt.	Std. SAE Socket	1/4" Dr.
80114	9/16"	6 Pt.	Std. SAE Socket	1/4" Dr.
80115	3/16"	6 Pt.	Deep SAE Socket	1/4" Dr.
80116	7/32"	6 Pt.	Deep SAE Socket	1/4" Dr.
80117	1/4"	6 Pt.	Deep SAE Socket	1/4" Dr.
80118	9/32"	6 Pt.	Deep SAE Socket	1/4" Dr.
80119	5/16"	6 Pt.	Deep SAE Socket	1/4" Dr.
80120	11/32"	6 Pt.	Deep SAE Socket	1/4" Dr.
80121	3/8"	6 Pt.	Deep SAE Socket	1/4" Dr.
80122	7/16"	6 Pt.	Deep SAE Socket	1/4" Dr.
80123	1/2"	6 Pt.	Deep SAE Socket	1/4" Dr.
80124	9/16"	6 Pt.	Deep SAE Socket	1/4" Dr.
81011	Full Polish Teardrop Ratchet			1/4" Dr.
81113	3" Extension			1/4" Dr.
81116	6" Extension			1/4" Dr.
81128	Spinner Handle			1/4" Dr.
80100	Universal Joint			1/4" Dr.

80313 - 26 Pc. SAE 12 Pt. Standard & Deep Socket Set 1/4" DRIVE

Item No.	Description	
80290	5/32" 12 Pt. Std. SAE Socket	1/4" Dr.
80210	3/16" 12 Pt. Std. SAE Socket	1/4" Dr.
80211	7/32" 12 Pt. Std. SAE Socket	1/4" Dr.
80212	1/4" 12 Pt. Std. SAE Socket	1/4" Dr.
80213	9/32" 12 Pt. Std. SAE Socket	1/4" Dr.
80214	5/16" 12 Pt. Std. SAE Socket	1/4" Dr.
80215	11/32" 12 Pt. Std. SAE Socket	1/4" Dr.
80216	3/8" 12 Pt. Std. SAE Socket	1/4" Dr.
80217	7/16" 12 Pt. Std. SAE Socket	1/4" Dr.
80218	1/2" 12 Pt. Std. SAE Socket	1/4" Dr.
80219	9/16" 12 Pt. Std. SAE Socket	1/4" Dr.
80220	3/16" 12 Pt. Deep SAE Socket	1/4" Dr.
80221	7/32" 12 Pt. Deep SAE Socket	1/4" Dr.
80222	1/4" 12 Pt. Deep SAE Socket	1/4" Dr.
80223	9/32" 12 Pt. Deep SAE Socket	1/4" Dr.
80224	5/16" 12 Pt. Deep SAE Socket	1/4" Dr.
80225	11/32" 12 Pt. Deep SAE Socket	1/4" Dr.
80226	3/8" 12 Pt. Deep SAE Socket	1/4" Dr.
80227	7/16" 12 Pt. Deep SAE Socket	1/4" Dr.
80228	1/2" 12 Pt. Deep SAE Socket	1/4" Dr.
80229	9/16" 12 Pt. Deep SAE Socket	1/4" Dr.
81011	Full Polish Teardrop Ratchet	1/4" Dr.
81113	3" Extension	1/4" Dr.
81116	6" Extension	1/4" Dr.
81128	Spinner Handle	1/4" Dr.
80100	Universal Joint	1/4" Dr.



1/4" DRIVE SETS
RATCHETS, SOCKETS & DRIVE TOOLS



80325 - 22 Pc. SAE 6 & 12 Pt. Standard & Deep Socket Set 1/4" DRIVE

Item No.	Description			
80115	3/16"	6 Pt.	Deep SAE Socket	1/4" Dr.
80116	7/32"	6 Pt.	Deep SAE Socket	1/4" Dr.
80117	1/4"	6 Pt.	Deep SAE Socket	1/4" Dr.
80118	9/32"	6 Pt.	Deep SAE Socket	1/4" Dr.
80119	5/16"	6 Pt.	Deep SAE Socket	1/4" Dr.
80120	11/32"	6 Pt.	Deep SAE Socket	1/4" Dr.
80121	3/8"	6 Pt.	Deep SAE Socket	1/4" Dr.

Item No.	Description			
80122	7/16"	6 Pt.	Deep SAE Socket	1/4" Dr.
80123	1/2"	6 Pt.	Deep SAE Socket	1/4" Dr.
80210	3/16"	12 Pt.	Std. SAE Socket	1/4" Dr.
80211	7/32"	12 Pt.	Std. SAE Socket	1/4" Dr.
80212	1/4"	12 Pt.	Std. SAE Socket	1/4" Dr.
80213	9/32"	12 Pt.	Std. SAE Socket	1/4" Dr.
80214	5/16"	12 Pt.	Std. SAE Socket	1/4" Dr.
80215	11/32"	12 Pt.	Std. SAE Socket	1/4" Dr.
80216	3/8"	12 Pt.	Std. SAE Socket	1/4" Dr.
80217	7/16"	12 Pt.	Std. SAE Socket	1/4" Dr.
80218	1/2"	12 Pt.	Std. SAE Socket	1/4" Dr.
81101	2" Extension			1/4" Dr.
81116	6" Extension			1/4" Dr.
81128	Spinner Handle			1/4" Dr.
81011	Full Polish Teardrop Ratchet			1/4" Dr.



80327 - 22 Pc. METRIC 6 & 12 Pt. Standard & Deep Socket Set 1/4" DRIVE

Item No.	Description			
80141	6 mm	6 Pt.	Deep Metric Socket	1/4" Dr.
80142	7 mm	6 Pt.	Deep Metric Socket	1/4" Dr.
80143	8 mm	6 Pt.	Deep Metric Socket	1/4" Dr.
80144	9 mm	6 Pt.	Deep Metric Socket	1/4" Dr.
80145	10 mm	6 Pt.	Deep Metric Socket	1/4" Dr.
80146	11 mm	6 Pt.	Deep Metric Socket	1/4" Dr.

Item No.	Description			
80147	12 mm	6 Pt.	Deep Metric Socket	1/4" Dr.
80148	13 mm	6 Pt.	Deep Metric Socket	1/4" Dr.
80149	14 mm	6 Pt.	Deep Metric Socket	1/4" Dr.
80197	4 mm	12 Pt.	Std. Metric Socket	1/4" Dr.
80198	5 mm	12 Pt.	Std. Metric Socket	1/4" Dr.
80200	6 mm	12 Pt.	Std. Metric Socket	1/4" Dr.
80201	7 mm	12 Pt.	Std. Metric Socket	1/4" Dr.
80202	8 mm	12 Pt.	Std. Metric Socket	1/4" Dr.
80203	9 mm	12 Pt.	Std. Metric Socket	1/4" Dr.
80204	10 mm	12 Pt.	Std. Metric Socket	1/4" Dr.
80205	11 mm	12 Pt.	Std. Metric Socket	1/4" Dr.
80206	12 mm	12 Pt.	Std. Metric Socket	1/4" Dr.
81101	2" Extension			1/4" Dr.
81116	6" Extension			1/4" Dr.
81128	Spinner Handle			1/4" Dr.
81011	Full Polish Teardrop Ratchet			1/4" Dr.

**80324 - 13 Pc. SAE 6 Pt. Standard Socket Set
1/4" DRIVE**

Item No.	Description			
80105	3/16"	6 Pt.	Std. SAE Socket	1/4" Dr.
80106	7/32"	6 Pt.	Std. SAE Socket	1/4" Dr.
80107	1/4"	6 Pt.	Std. SAE Socket	1/4" Dr.
80108	9/32"	6 Pt.	Std. SAE Socket	1/4" Dr.
80109	5/16"	6 Pt.	Std. SAE Socket	1/4" Dr.
80110	11/32"	6 Pt.	Std. SAE Socket	1/4" Dr.
80111	3/8"	6 Pt.	Std. SAE Socket	1/4" Dr.
80112	7/16"	6 Pt.	Std. SAE Socket	1/4" Dr.
80113	1/2"	6 Pt.	Std. SAE Socket	1/4" Dr.
81101	2" Extension			1/4" Dr.
81116	6" Extension			1/4" Dr.
81128	Spinner Handle			1/4" Dr.
81011	Full Polish Teardrop Ratchet			1/4" Dr.



**80326 - 14 Pc. METRIC 6 & 12 Pt. Standard
Socket Set 1/4" DRIVE**

Item No.	Description			
80125	4 mm	6 Pt.	Std. Metric Socket	1/4" Dr.
80126	5 mm	6 Pt.	Std. Metric Socket	1/4" Dr.
80128	6 mm	6 Pt.	Std. Metric Socket	1/4" Dr.
80129	7 mm	6 Pt.	Std. Metric Socket	1/4" Dr.
80130	8 mm	6 Pt.	Std. Metric Socket	1/4" Dr.
80131	9 mm	6 Pt.	Metric Socket	1/4" Dr.
80132	10 mm	6 Pt.	Std. Metric Socket	1/4" Dr.
80133	11 mm	6 Pt.	Std. Metric Socket	1/4" Dr.
80134	12 mm	6 Pt.	Std. Metric Socket	1/4" Dr.
80135	13 mm	6 Pt.	Std. Metric Socket	1/4" Dr.
81101	2" Extension			1/4" Dr.
81116	6" Extension			1/4" Dr.
81128	Spinner Handle			1/4" Dr.
81011	Full Polish Teardrop Ratchet			1/4" Dr.



1/4" DRIVE SETS

RATCHETS, SOCKETS & DRIVE TOOLS



**80314 - 47 Pc. SAE/METRIC 6 Pt. Standard & Deep Socket Accessory Set
1/4" DRIVE**

Item No.	Description			
80104	5/32"	6 Pt.	Std. SAE Socket	1/4" Dr.
80105	3/16"	6 Pt.	Std. SAE Socket	1/4" Dr.
80106	7/32"	6 Pt.	Std. SAE Socket	1/4" Dr.
80107	1/4"	6 Pt.	Std. SAE Socket	1/4" Dr.
80108	9/32"	6 Pt.	Std. SAE Socket	1/4" Dr.
80109	5/16"	6 Pt.	Std. SAE Socket	1/4" Dr.
80110	11/32"	6 Pt.	Std. SAE Socket	1/4" Dr.
80111	3/8"	6 Pt.	Std. SAE Socket	1/4" Dr.
80112	7/16"	6 Pt.	Std. SAE Socket	1/4" Dr.
80113	1/2"	6 Pt.	Std. SAE Socket	1/4" Dr.
80114	9/16"	6 Pt.	Std. SAE Socket	1/4" Dr.
80125	4 mm	6 Pt.	Std. Metric Socket	1/4" Dr.
80126	5 mm	6 Pt.	Std. Metric Socket	1/4" Dr.
80127	5.5 mm	6 Pt.	Std. Metric Socket	1/4" Dr.
80128	6 mm	6 Pt.	Std. Metric Socket	1/4" Dr.
80129	7 mm	6 Pt.	Std. Metric Socket	1/4" Dr.
80130	8 mm	6 Pt.	Std. Metric Socket	1/4" Dr.
80131	9 mm	6 Pt.	Std. Metric Socket	1/4" Dr.
80132	10 mm	6 Pt.	Std. Metric Socket	1/4" Dr.
80133	11 mm	6 Pt.	Std. Metric Socket	1/4" Dr.
80134	12 mm	6 Pt.	Std. Metric Socket	1/4" Dr.
80135	13 mm	6 Pt.	Std. Metric Socket	1/4" Dr.

Item No.	Description			
80136	14 mm	6 Pt.	Std. Metric Socket	1/4" Dr.
80137	15 mm	6 Pt.	Std. Metric Socket	1/4" Dr.
80115	3/16"	6 Pt.	Deep SAE Socket	1/4" Dr.
80116	7/32"	6 Pt.	Deep SAE Socket	1/4" Dr.
80117	1/4"	6 Pt.	Deep SAE Socket	1/4" Dr.
80118	9/32"	6 Pt.	Deep SAE Socket	1/4" Dr.
80119	5/16"	6 Pt.	Deep SAE Socket	1/4" Dr.
80120	11/32"	6 Pt.	Deep SAE Socket	1/4" Dr.
80121	3/8"	6 Pt.	Deep SAE Socket	1/4" Dr.
80122	7/16"	6 Pt.	Deep SAE Socket	1/4" Dr.
80123	1/2"	6 Pt.	Deep SAE Socket	1/4" Dr.
80124	9/16"	6 Pt.	Deep SAE Socket	1/4" Dr.
80138	4 mm	6 Pt.	Deep Metric Socket	1/4" Dr.
80139	5 mm	6 Pt.	Deep Metric Socket	1/4" Dr.
80140	5.5 mm	6 Pt.	Deep Metric Socket	1/4" Dr.
80141	6 mm	6 Pt.	Deep Metric Socket	1/4" Dr.
80142	7 mm	6 Pt.	Deep Metric Socket	1/4" Dr.
80143	8 mm	6 Pt.	Deep Metric Socket	1/4" Dr.
80144	9 mm	6 Pt.	Deep Metric Socket	1/4" Dr.
80145	10 mm	6 Pt.	Deep Metric Socket	1/4" Dr.
80146	11 mm	6 Pt.	Deep Metric Socket	1/4" Dr.
80147	12 mm	6 Pt.	Deep Metric Socket	1/4" Dr.
80148	13 mm	6 Pt.	Deep Metric Socket	1/4" Dr.
80149	14 mm	6 Pt.	Deep Metric Socket	1/4" Dr.
80150	15 mm	6 Pt.	Deep Metric Socket	1/4" Dr.

**80303 - 10 Pc. SAE 6 Pt. Standard Socket Set
1/4" DRIVE**

Item No.	Description			
80105	3/16"	6 Pt.	Std. SAE Socket	1/4" Dr.
80106	7/32"	6 Pt.	Std. SAE Socket	1/4" Dr.
80107	1/4"	6 Pt.	Std. SAE Socket	1/4" Dr.
80108	9/32"	6 Pt.	Std. SAE Socket	1/4" Dr.
80109	5/16"	6 Pt.	Std. SAE Socket	1/4" Dr.
80110	11/32"	6 Pt.	Std. SAE Socket	1/4" Dr.



Item No.	Description			
80111	3/8"	6 Pt.	Std. SAE Socket	1/4" Dr.
80112	7/16"	6 Pt.	Std. SAE Socket	1/4" Dr.
80113	1/2"	6 Pt.	Std. SAE Socket	1/4" Dr.
80114	9/16"	6 Pt.	Std. SAE Socket	1/4" Dr.

**80307 - 10 Pc. SAE 12 Pt. Standard Socket Set
1/4" DRIVE**

Item No.	Description			
80210	3/16"	12 Pt.	Std. SAE Socket	1/4" Dr.
80211	7/32"	12 Pt.	Std. SAE Socket	1/4" Dr.
80212	1/4"	12 Pt.	Std. SAE Socket	1/4" Dr.
80213	9/32"	12 Pt.	Std. SAE Socket	1/4" Dr.
80214	5/16"	12 Pt.	Std. SAE Socket	1/4" Dr.
80215	11/32"	12 Pt.	Std. SAE Socket	1/4" Dr.



Item No.	Description			
80216	3/8"	12 Pt.	Std. SAE Socket	1/4" Dr.
80217	7/16"	12 Pt.	Std. SAE Socket	1/4" Dr.
80218	1/2"	12 Pt.	Std. SAE Socket	1/4" Dr.
80219	9/16"	12 Pt.	Std. SAE Socket	1/4" Dr.

**80305 - 10 Pc. SAE 6 Pt. Deep Socket Set
1/4" DRIVE**

Item No.	Description			
80115	3/16"	6 Pt.	Deep SAE Socket	1/4" Dr.
80116	7/32"	6 Pt.	Deep SAE Socket	1/4" Dr.
80117	1/4"	6 Pt.	Deep SAE Socket	1/4" Dr.
80118	9/32"	6 Pt.	Deep SAE Socket	1/4" Dr.
80119	5/16"	6 Pt.	Deep SAE Socket	1/4" Dr.
80120	11/32"	6 Pt.	Deep SAE Socket	1/4" Dr.
80121	3/8"	6 Pt.	Deep SAE Socket	1/4" Dr.



Item No.	Description			
80122	7/16"	6 Pt.	Deep SAE Socket	1/4" Dr.
80123	1/2"	6 Pt.	Deep SAE Socket	1/4" Dr.
80124	9/16"	6 Pt.	Deep SAE Socket	1/4" Dr.

1/4" DRIVE SETS

RATCHETS, SOCKETS & DRIVE TOOLS



**80309 - 10 Pc. SAE 12 Pt. Deep Socket Set
1/4" DRIVE**

Item No.	Description		
80220	3/16"	12 Pt. Deep SAE Socket	1/4" Dr.
80221	7/32"	12 Pt. Deep SAE Socket	1/4" Dr.
80222	1/4"	12 Pt. Deep SAE Socket	1/4" Dr.

Item No.	Description		
80223	9/32"	12 Pt. Deep SAE Socket	1/4" Dr.
80224	5/16"	12 Pt. Deep SAE Socket	1/4" Dr.
80225	11/32"	12 Pt. Deep SAE Socket	1/4" Dr.
80226	3/8"	12 Pt. Deep SAE Socket	1/4" Dr.
80227	7/16"	12 Pt. Deep SAE Socket	1/4" Dr.
80228	1/2"	12 Pt. Deep SAE Socket	1/4" Dr.
80229	9/16"	12 Pt. Deep SAE Socket	1/4" Dr.



**80302 - 13 Pc. METRIC 6 Pt. Standard Socket Set
1/4" DRIVE**

Item No.	Description		
80125	4 mm	6 Pt. Std. Metric Socket	1/4" Dr.
80126	5 mm	6 Pt. Std. Metric Socket	1/4" Dr.
80127	5.5 mm	6 Pt. Std. Metric Socket	1/4" Dr.
80128	6 mm	6 Pt. Std. Metric Socket	1/4" Dr.
80129	7 mm	6 Pt. Std. Metric Socket	1/4" Dr.

Item No.	Description		
80130	8 mm	6 Pt. Std. Metric Socket	1/4" Dr.
80131	9 mm	6 Pt. Std. Metric Socket	1/4" Dr.
80132	10 mm	6 Pt. Std. Metric Socket	1/4" Dr.
80133	11 mm	6 Pt. Std. Metric Socket	1/4" Dr.
80134	12 mm	6 Pt. Std. Metric Socket	1/4" Dr.
80135	13 mm	6 Pt. Std. Metric Socket	1/4" Dr.
80136	14 mm	6 Pt. Std. Metric Socket	1/4" Dr.
80137	15 mm	6 Pt. Std. Metric Socket	1/4" Dr.



**80306 - 13 Pc. METRIC 12 Pt. Standard Socket Set
1/4" DRIVE**

Item No.	Description		
80197	4 mm	12 Pt. Std. Metric Socket	1/4" Dr.
80198	5 mm	12 Pt. Std. Metric Socket	1/4" Dr.
80199	5.5 mm	12 Pt. Std. Metric Socket	1/4" Dr.
80200	6 mm	12 Pt. Std. Metric Socket	1/4" Dr.
80201	7 mm	12 Pt. Std. Metric Socket	1/4" Dr.

Item No.	Description		
80202	8 mm	12 Pt. Std. Metric Socket	1/4" Dr.
80203	9 mm	12 Pt. Std. Metric Socket	1/4" Dr.
80204	10 mm	12 Pt. Std. Metric Socket	1/4" Dr.
80205	11 mm	12 Pt. Std. Metric Socket	1/4" Dr.
80206	12 mm	12 Pt. Std. Metric Socket	1/4" Dr.
80207	13 mm	12 Pt. Std. Metric Socket	1/4" Dr.
80208	14 mm	12 Pt. Std. Metric Socket	1/4" Dr.
80209	15 mm	12 Pt. Std. Metric Socket	1/4" Dr.

**80304 - 13 Pc. METRIC 6 Pt. Deep Socket Set
1/4" DRIVE**

Item No.	Description
80138	4 mm 6 Pt. Deep Metric Socket 1/4" Dr.
80139	5 mm 6 Pt. Deep Metric Socket 1/4" Dr.
80140	5.5 mm 6 Pt. Deep Metric Socket 1/4" Dr.
80141	6 mm 6 Pt. Deep Metric Socket 1/4" Dr.
80142	7 mm 6 Pt. Deep Metric Socket 1/4" Dr.
80143	8 mm 6 Pt. Deep Metric Socket 1/4" Dr.
80144	9 mm 6 Pt. Deep Metric Socket 1/4" Dr.
80145	10 mm 6 Pt. Deep Metric Socket 1/4" Dr.



Item No.	Description
80146	11 mm 6 Pt. Deep Metric Socket 1/4" Dr.
80147	12 mm 6 Pt. Deep Metric Socket 1/4" Dr.
80148	13 mm 6 Pt. Deep Metric Socket 1/4" Dr.
80149	14 mm 6 Pt. Deep Metric Socket 1/4" Dr.
80150	15 mm 6 Pt. Deep Metric Socket 1/4" Dr.

**80308 - 13 Pc. METRIC 12 Pt. Deep Socket Set
1/4" DRIVE**

Item No.	Description
80230	4 mm 12 Pt. Deep Metric Socket 1/4" Dr.
80231	5 mm 12 Pt. Deep Metric Socket 1/4" Dr.
80232	5.5 mm 12 Pt. Deep Metric Socket 1/4" Dr.
80233	6 mm 12 Pt. Deep Metric Socket 1/4" Dr.
80234	7 mm 12 Pt. Deep Metric Socket 1/4" Dr.
80235	8 mm 12 Pt. Deep Metric Socket 1/4" Dr.
80236	9 mm 12 Pt. Deep Metric Socket 1/4" Dr.
80237	10 mm 12 Pt. Deep Metric Socket 1/4" Dr.



Item No.	Description
80238	11 mm 12 Pt. Deep Metric Socket 1/4" Dr.
80239	12 mm 12 Pt. Deep Metric Socket 1/4" Dr.
80240	13 mm 12 Pt. Deep Metric Socket 1/4" Dr.
80241	14 mm 12 Pt. Deep Metric Socket 1/4" Dr.
80242	15 mm 12 Pt. Deep Metric Socket 1/4" Dr.

**80310 - 7 Pc. SAE 6 Pt. Flex Socket Set
1/4" DRIVE**

Item No.	Description
80262	3/16" 6 Pt. Flex SAE Socket 1/4" Dr.
80263	1/4" 6 Pt. Flex SAE Socket 1/4" Dr.
80264	5/16" 6 Pt. Flex SAE Socket 1/4" Dr.
80265	3/8" 6 Pt. Flex SAE Socket 1/4" Dr.
80266	7/16" 6 Pt. Flex SAE Socket 1/4" Dr.
80267	1/2" 6 Pt. Flex SAE Socket 1/4" Dr.
80268	9/16" 6 Pt. Flex SAE Socket 1/4" Dr.

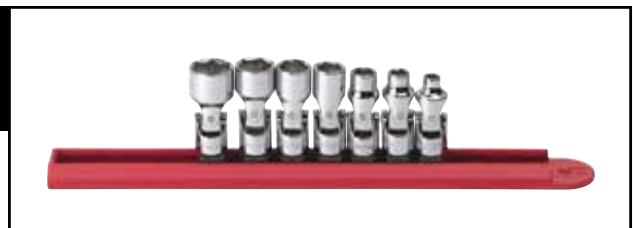



**80311 - 12 Pc. METRIC 6 Pt. Flex Socket Set
1/4" DRIVE**

Item No.	Description	Overall Length (inch)	Weight (lbs)
80257	11 mm 6 Pt. Flex Metric Socket	1/4" Dr.	
80258	12 mm 6 Pt. Flex Metric Socket	1/4" Dr.	
80259	13 mm 6 Pt. Flex Metric Socket	1/4" Dr.	
80260	14 mm 6 Pt. Flex Metric Socket	1/4" Dr.	
80261	15 mm 6 Pt. Flex Metric Socket	1/4" Dr.	

Item No.	Description	Overall Length (inch)	Weight (lbs)
80250	5 mm 6 Pt. Flex Metric Socket	1/4" Dr.	
80251	5.5 mm 6 Pt. Flex Metric Socket	1/4" Dr.	
80252	6 mm 6 Pt. Flex Metric Socket	1/4" Dr.	
80253	7 mm 6 Pt. Flex Metric Socket	1/4" Dr.	
80254	8 mm 6 Pt. Flex Metric Socket	1/4" Dr.	
80255	9 mm 6 Pt. Flex Metric Socket	1/4" Dr.	
80256	10 mm 6 Pt. Flex Metric Socket	1/4" Dr.	



Full Polish Teardrop Ratchet 1/4" DRIVE

Item No.	Description	Overall Length (inch)	Weight (lbs)
81011	Full Polish Teardrop Ratchet	5.13"	0.220

- 60 tooth low profile ratchet

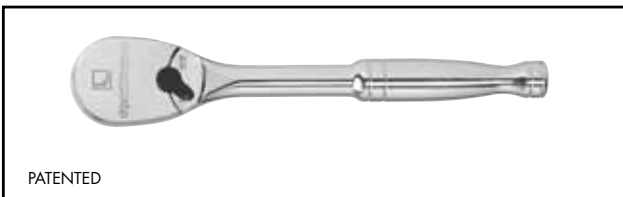

Full Polish Flex Teardrop Ratchet 1/4" DRIVE

Item No.	Description	Overall Length (inch)	Weight (lbs)
81012	Full Polish Flex Teardrop Ratchet	6.97"	0.330

- 60 tooth low profile ratchet

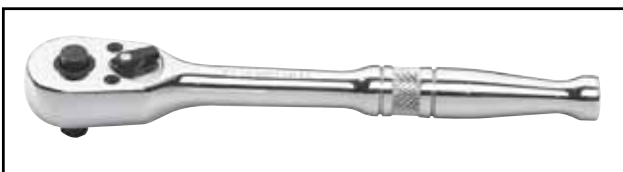

Quick-Release Teardrop Ratchet 1/4" DRIVE

Item No.	Description	Overall Length (inch)	Weight (lbs)
81014	Quick-Release Teardrop Ratchet	5.63"	0.200

- 45 tooth standard ratchet



Cushion Grip Teardrop Ratchet 1/4" DRIVE

Item No.	Description	Overall Length (inch)	Weight (lbs)
81007	Cushion Grip Teardrop Ratchet	6.42"	0.290

- 60 tooth low profile ratchet



Cushion Grip Flex Teardrop Ratchet 1/4" DRIVE

Item No.	Description	Overall Length (inch)	Weight (lbs)
81009	Cushion Grip Flex Teardrop Ratchet	7.76"	0.400

- 60 tooth low profile ratchet

Cushion Grip Roto Ratchet 1/4" DRIVE

Item No.	Description	Weight (lbs)
81224	Cushion Grip Roto Ratchet	0.290

- 72 tooth roto ratchet



Ratchet Repair Kit 1/4" DRIVE

Item No.	Description
81099	Ratchet Repair Kit

- for non-quick release and non-roto ratchets

Spinner Handle 1/4" DRIVE

Item No.	Description	Weight (lbs)
81128	Spinner Handle	0.264

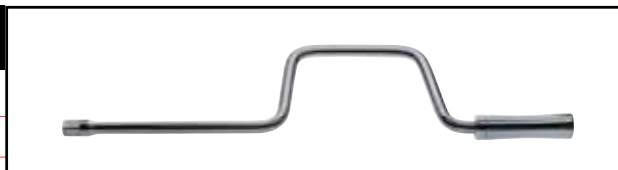

Thumbwheel Ratchet 1/4" DRIVE

Item No.	Description	Weight (lbs)
81008	Thumbwheel Ratchet	0.101



Flex handle 1/4" DRIVE

Item No.	Description	Overall Length (inch)	Weight (lbs)
81013	Flex Handle	5.43"	.0293



Universal Joint 1/4" DRIVE

Item No.	Description	Weight (lbs)
80100	Universal Joint	0.044



Spring Universal Joint 1/4" DRIVE

Item No.	Description	Weight (lbs)
81232	Spring Universal Joint	0.070



PATENTED

1/4" OPEN STOCK
RATCHETS, SOCKETS & DRIVE TOOLS



Magnetic Universal Joint 1/4" DRIVE

Item No.	Description	Weight (lbs)
81255	Magnetic Universal Joint	0.107



Adapter 1/4" DRIVE

Item No.	Description	Weight (lbs)
81127	Adapter 1/4" F x 3/8" M	0.044



Magnetic Adapter 1/4" DRIVE

Item No.	Description	Weight (lbs)
81258	Magnetic Adapter 1/4" F x 3/8" M	0.084



Standard Extension 1/4" DRIVE

Item No.	Description	Weight (lbs)
81101	2" Standard Extension	0.066
81113	3" Standard Extension	0.077
81114	4" Standard Extension	0.132
81116	6" Standard Extension	0.176
81117	10" Standard Extension	0.242
81118	14" Standard Extension	0.330



81002 - 5 Pc. Standard Extension Set 1/4" DRIVE

Item No.	Description	Weight (lbs)
81101	2" Standard Extension	0.066
81113	3" Standard Extension	0.077
81114	4" Standard Extension	0.132
81116	6" Standard Extension	0.176
81118	14" Standard Extension	0.330



Magnetic Extension 1/4" DRIVE

Item No.	Description	Weight (lbs)
81261	6" Magnetic Extension	0.330

81004 - 4 Pc. Wobble Extension Set 1/4" DRIVE

Item No.	Description	Weight (lbs)
81119	2" Wobble Extension	0.066
81120	4" Wobble Extension	0.132
81121	6" Wobble Extension	0.176
81122	14" Wobble Extension	0.330



Locking Extension 1/4" DRIVE

Item No.	Description	Weight (lbs)
81123	2" Locking Extension	0.066
81124	3" Locking Extension	0.077
81125	4" Locking Extension	0.100
81126	6" Locking Extension	0.176



81003 - 3 Pc. Locking Extension Set 1/4" DRIVE

Item No.	Description	Weight (lbs)
81123	2" Locking Extension	0.066
81124	3" Locking Extension	0.077
81126	6" Locking Extension	0.176



1/4" OPEN STOCK

RATCHETS, SOCKETS & DRIVE TOOLS

RATCHETS, SOCKETS & DRIVE TOOLS 1/4" OPEN STOCK



6 & 12 Pt. Standard Socket SAE/METRIC 1/4" DRIVE

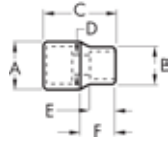

Item No.	Size	Description	Drive End	Wrench	Overall	Bolt	Wrench	Length to	Weight (lbs)
			(inch) A	End (inch) B	Length (inch) C	Clearance D	Depth (inch) E	Shoulder F	
80104	5/32"	6 Pt. Std. SAE	0.465	0.272	0.965	0.134	0.295	0.453	0.022
80105	3/16"	6 Pt. Std. SAE	0.465	0.307	0.965	0.157	0.315	0.453	0.022
80106	7/32"	6 Pt. Std. SAE	0.465	0.335	0.965	0.157	0.315	0.453	0.022
80107	1/4"	6 Pt. Std. SAE	0.465	0.374	0.965	0.157	0.354	0.453	0.022
80108	9/32"	6 Pt. Std. SAE	0.465	0.421	0.965	0.220	0.394	0.453	0.022
80109	5/16"	6 Pt. Std. SAE	0.465	0.453	0.965	0.220	0.413	0.453	0.026
80110	11/32"	6 Pt. Std. SAE	0.492	0.492	0.965	0.220	0.413	0.453	0.033
80111	3/8"	6 Pt. Std. SAE	0.543	0.543	0.965	0.220	0.492	0.453	0.044
80112	7/16"	6 Pt. Std. SAE	0.618	0.618	0.965	0.220	0.492	0.453	0.044
80113	1/2"	6 Pt. Std. SAE	0.681	0.681	0.965	0.220	0.492	0.453	0.055
80114	9/16"	6 Pt. Std. SAE	0.768	0.768	0.965	0.220	0.571	0.453	0.059
80290	5/32"	12 Pt. Std. SAE	0.465	0.272	0.965	0.134	0.295	0.453	0.022
80210	3/16"	12 Pt. Std. SAE	0.465	0.307	0.965	0.157	0.315	0.453	0.022
80211	7/32"	12 Pt. Std. SAE	0.465	0.335	0.965	0.157	0.315	0.453	0.022
80212	1/4"	12 Pt. Std. SAE	0.465	0.374	0.965	0.157	0.354	0.453	0.022
80213	9/32"	12 Pt. Std. SAE	0.465	0.421	0.965	0.220	0.394	0.453	0.022
80214	5/16"	12 Pt. Std. SAE	0.465	0.453	0.965	0.220	0.413	0.453	0.026
80215	11/32"	12 Pt. Std. SAE	0.492	0.492	0.965	0.220	0.413	0.453	0.033
80216	3/8"	12 Pt. Std. SAE	0.543	0.543	0.965	0.220	0.492	0.453	0.044
80217	7/16"	12 Pt. Std. SAE	0.618	0.618	0.965	0.220	0.492	0.453	0.044
80218	1/2"	12 Pt. Std. SAE	0.681	0.681	0.965	0.220	0.492	0.453	0.055
80219	9/16"	12 Pt. Std. SAE	0.768	0.768	0.965	0.220	0.571	0.453	0.059
80125	4 mm	6 Pt. Std. Metric	0.465	0.264	0.965	0.134	0.315	0.453	0.022
80126	5 mm	6 Pt. Std. Metric	0.465	0.315	0.965	0.157	0.315	0.453	0.022
80127	5.5 mm	6 Pt. Std. Metric	0.465	0.339	0.965	0.157	0.315	0.453	0.022
80128	6 mm	6 Pt. Std. Metric	0.465	0.362	0.965	0.157	0.354	0.453	0.022

6 & 12 Pt. Standard Socket SAE/METRIC 1/4" DRIVE

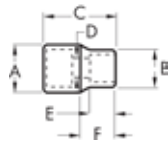

Item No.	Size	Description	Drive End	Wrench	Overall	Bolt	Wrench	Length to	Weight (lbs)
			(inch)	End (inch)	Length (inch)	Clearance	Depth (inch)	Shoulder	
			A	B	C	D	E	F	
80129	7 mm	6 Pt. Std. Metric	0.465	0.421	0.965	0.220	0.374	0.453	0.022
80130	8 mm	6 Pt. Std. Metric	0.465	0.453	0.965	0.220	0.394	0.453	0.026
80131	9 mm	6 Pt. Std. Metric	0.516	0.516	0.965	0.220	0.413	0.453	0.033
80132	10 mm	6 Pt. Std. Metric	0.563	0.563	0.965	0.220	0.492	0.453	0.040
80133	11 mm	6 Pt. Std. Metric	0.622	0.622	0.965	0.220	0.492	0.453	0.044
80134	12 mm	6 Pt. Std. Metric	0.661	0.661	0.965	0.220	0.492	0.453	0.048
80135	13 mm	6 Pt. Std. Metric	0.705	0.705	0.965	0.220	0.492	0.453	0.059
80136	14 mm	6 Pt. Std. Metric	0.768	0.768	0.965	0.220	0.571	0.453	0.059
80137	15 mm	6 Pt. Std. Metric	0.819	0.819	0.965	0.220	0.571	0.453	0.066
80197	4 mm	12 Pt. Std. Metric	0.465	0.264	0.965	0.134	0.315	0.453	0.022
80198	5 mm	12 Pt. Std. Metric	0.465	0.315	0.965	0.157	0.315	0.453	0.022
80199	5.5 mm	12 Pt. Std. Metric	0.465	0.339	0.965	0.157	0.315	0.453	0.022
80200	6 mm	12 Pt. Std. Metric	0.465	0.362	0.965	0.157	0.354	0.453	0.022
80201	7 mm	12 Pt. Std. Metric	0.465	0.421	0.965	0.220	0.374	0.453	0.022
80202	8 mm	12 Pt. Std. Metric	0.465	0.453	0.965	0.220	0.394	0.453	0.026
80203	9 mm	12 Pt. Std. Metric	0.516	0.516	0.965	0.220	0.413	0.453	0.033
80204	10 mm	12 Pt. Std. Metric	0.563	0.563	0.965	0.220	0.492	0.453	0.040
80205	11 mm	12 Pt. Std. Metric	0.622	0.622	0.965	0.220	0.492	0.453	0.044
80206	12 mm	12 Pt. Std. Metric	0.661	0.661	0.965	0.220	0.492	0.453	0.048
80207	13 mm	12 Pt. Std. Metric	0.705	0.705	0.965	0.220	0.492	0.453	0.059
80208	14 mm	12 Pt. Std. Metric	0.768	0.768	0.965	0.220	0.571	0.453	0.059
80209	15 mm	12 Pt. Std. Metric	0.819	0.819	0.965	0.220	0.571	0.453	0.066

1/4" OPEN STOCK

RATCHETS, SOCKETS & DRIVE TOOLS

RATCHETS, SOCKETS & DRIVE TOOLS 1/4" OPEN STOCK



6 & 12 Pt. Deep Socket SAE/METRIC 1/4" DRIVE

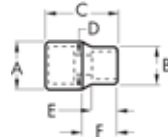

Item No.	Size	Description	Drive End	Wrench	Overall	Bolt	Wrench	Length to	Weight (lbs)
			(inch) A	End (inch) B	Length (inch) C	Clearance D	Depth (inch) E	Shoulder F	
80115	3/16"	6 Pt. Deep SAE	0.469	0.307	1.929	0.177	0.138	0.866	0.040
80116	7/32"	6 Pt. Deep SAE	0.469	0.346	1.929	0.197	0.138	0.866	0.044
80117	1/4"	6 Pt. Deep SAE	0.469	0.390	1.929	0.217	0.157	0.866	0.046
80118	9/32"	6 Pt. Deep SAE	0.469	0.433	1.929	0.217	0.197	0.866	0.046
80119	5/16"	6 Pt. Deep SAE	0.469	0.453	1.929	0.217	0.197	0.866	0.046
80120	11/32"	6 Pt. Deep SAE	0.516	0.516	1.929	0.217	0.197	0.866	0.064
80121	3/8"	6 Pt. Deep SAE	0.575	0.575	1.929	0.217	0.201	0.866	0.088
80122	7/16"	6 Pt. Deep SAE	0.626	0.626	1.929	0.217	0.236	0.866	0.101
80123	1/2"	6 Pt. Deep SAE	0.705	0.705	1.929	0.217	0.287	0.866	0.128
80124	9/16"	6 Pt. Deep SAE	0.772	0.772	1.929	0.217	0.350	0.866	0.132
80220	3/16"	12 Pt. Deep SAE	0.469	0.307	1.929	0.177	0.138	0.866	0.040
80221	7/32"	12 Pt. Deep SAE	0.469	0.346	1.929	0.197	0.138	0.866	0.044
80222	1/4"	12 Pt. Deep SAE	0.469	0.390	1.929	0.217	0.157	0.866	0.046
80223	9/32"	12 Pt. Deep SAE	0.469	0.433	1.929	0.217	0.197	0.866	0.046
80224	5/16"	12 Pt. Deep SAE	0.469	0.453	1.929	0.217	0.197	0.866	0.046
80225	11/32"	12 Pt. Deep SAE	0.516	0.516	1.929	0.217	0.197	0.866	0.064
80226	3/8"	12 Pt. Deep SAE	0.575	0.575	1.929	0.217	0.201	0.866	0.088
80227	7/16"	12 Pt. Deep SAE	0.626	0.626	1.929	0.217	0.236	0.866	0.101
80228	1/2"	12 Pt. Deep SAE	0.705	0.705	1.929	0.217	0.287	0.866	0.128
80229	9/16"	12 Pt. Deep SAE	0.772	0.772	1.929	0.217	0.350	0.866	0.132
80138	4 mm	6 Pt. Deep Metric	0.469	0.264	1.929	0.138	0.118	0.866	0.040
80139	5 mm	6 Pt. Deep Metric	0.469	0.315	1.929	0.177	0.138	0.866	0.040
80140	5.5 mm	6 Pt. Deep Metric	0.469	0.339	1.929	0.197	0.138	0.866	0.040
80141	6 mm	6 Pt. Deep Metric	0.469	0.362	1.929	0.217	0.157	0.866	0.046
80142	7 mm	6 Pt. Deep Metric	0.469	0.425	1.929	0.217	0.197	0.866	0.055
80143	8 mm	6 Pt. Deep Metric	0.469	0.453	1.929	0.217	0.197	0.866	0.055

6 & 12 Pt. Deep Socket SAE/METRIC 1/4" DRIVE

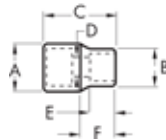

Item No.	Size	Description	Drive End	Wrench	Overall	Bolt	Wrench	Length to	Weight (lbs)
			(inch) A	End (inch) B	Length (inch) C	Clearance D	Depth (inch) E	Shoulder F	
80144	9 mm	6 Pt. Deep Metric	0.516	0.516	1.929	0.217	0.197	0.866	0.070
80145	10 mm	6 Pt. Deep Metric	0.575	0.575	1.929	0.217	0.217	0.866	0.084
80146	11 mm	6 Pt. Deep Metric	0.626	0.626	1.929	0.217	0.256	0.866	0.106
80147	12 mm	6 Pt. Deep Metric	0.665	0.665	1.929	0.217	0.276	0.866	0.110
80148	13 mm	6 Pt. Deep Metric	0.705	0.705	1.929	0.217	0.303	0.866	0.121
80149	14 mm	6 Pt. Deep Metric	0.772	0.772	1.929	0.217	0.350	0.866	0.132
80150	15 mm	6 Pt. Deep Metric	0.819	0.819	1.929	0.217	0.350	0.866	0.154
80230	4 mm	12 Pt. Deep Metric	0.469	0.264	1.929	0.138	0.118	0.866	0.040
80231	5 mm	12 Pt. Deep Metric	0.469	0.315	1.929	0.177	0.138	0.866	0.040
80232	5.5 mm	12 Pt. Deep Metric	0.469	0.339	1.929	0.197	0.138	0.866	0.040
80233	6 mm	12 Pt. Deep Metric	0.469	0.362	1.929	0.217	0.157	0.866	0.046
80234	7 mm	12 Pt. Deep Metric	0.469	0.425	1.929	0.217	0.197	0.866	0.055
80235	8 mm	12 Pt. Deep Metric	0.469	0.453	1.929	0.217	0.197	0.866	0.055
80236	9 mm	12 Pt. Deep Metric	0.516	0.516	1.929	0.217	0.197	0.866	0.070
80237	10 mm	12 Pt. Deep Metric	0.575	0.575	1.929	0.217	0.217	0.866	0.084
80238	11 mm	12 Pt. Deep Metric	0.626	0.626	1.929	0.217	0.256	0.866	0.106
80239	12 mm	12 Pt. Deep Metric	0.665	0.665	1.929	0.217	0.276	0.866	0.110
80240	13 mm	12 Pt. Deep Metric	0.705	0.705	1.929	0.217	0.303	0.866	0.121
80241	14 mm	12 Pt. Deep Metric	0.772	0.772	1.929	0.217	0.350	0.866	0.132
80242	15 mm	12 Pt. Deep Metric	0.819	0.819	1.929	0.217	0.350	0.866	0.154

1/4" OPEN STOCK

RATCHETS, SOCKETS & DRIVE TOOLS



6 Pt. Flex Socket SAE/METRIC 1/4" DRIVE

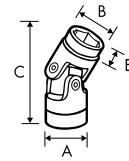

Item No.	Size	Description	Drive End (inch) A	Wrench End (inch) B	Overall Length (inch) C	Bolt Clearance D	Wrench Depth (inch) E	Length to Shoulder F	Weight (lbs)
80262	3/16"	6 Pt. Flex SAE	0.551	0.378	1.378	N/A	0.240	N/A	0.048
80263	1/4"	6 Pt. Flex SAE	0.551	0.378	1.378	N/A	0.270	N/A	0.048
80264	5/16"	6 Pt. Flex SAE	0.551	0.465	1.378	N/A	0.240	N/A	0.052
80265	3/8"	6 Pt. Flex SAE	0.551	0.543	1.457	N/A	0.300	N/A	0.055
80266	7/16"	6 Pt. Flex SAE	0.551	0.598	1.457	N/A	0.320	N/A	0.062
80267	1/2"	6 Pt. Flex SAE	0.551	0.677	1.457	N/A	0.320	N/A	0.065
80268	9/16"	6 Pt. Flex SAE	0.551	0.740	1.457	N/A	0.420	N/A	0.067
80250	5 mm	6 Pt. Flex Metric	0.551	0.315	1.378	N/A	0.270	N/A	0.048
80251	5.5 mm	6 Pt. Flex Metric	0.551	0.337	1.378	N/A	0.290	N/A	0.050
80252	6 mm	6 Pt. Flex Metric	0.551	0.378	1.378	N/A	0.290	N/A	0.048
80253	7 mm	6 Pt. Flex Metric	0.551	0.425	1.378	N/A	0.270	N/A	0.050
80254	8 mm	6 Pt. Flex Metric	0.551	0.465	1.378	N/A	0.270	N/A	0.052
80255	9 mm	6 Pt. Flex Metric	0.551	0.500	1.457	N/A	0.300	N/A	0.054
80256	10 mm	6 Pt. Flex Metric	0.551	0.543	1.457	N/A	0.270	N/A	0.055
80257	11 mm	6 Pt. Flex Metric	0.551	0.598	1.457	N/A	0.320	N/A	0.062
80258	12 mm	6 Pt. Flex Metric	0.551	0.646	1.457	N/A	0.320	N/A	0.062
80259	13 mm	6 Pt. Flex Metric	0.551	0.677	1.457	N/A	0.320	N/A	0.065
80260	14 mm	6 Pt. Flex Metric	0.551	0.740	1.457	N/A	0.400	N/A	0.067
80261	15 mm	6 Pt. Flex Metric	0.551	0.799	1.457	N/A	0.400	N/A	0.073

80550 - 57 Pc. SAE/METRIC 6 Pt. Standard & Deep Socket Set 3/8" DRIVE

Item No.	Description			
80350	1/4"	6 Pt.	Std. SAE Socket	3/8" Dr.
80351	5/16"	6 Pt.	Std. SAE Socket	3/8" Dr.
80352	3/8"	6 Pt.	Std. SAE Socket	3/8" Dr.
80353	7/16"	6 Pt.	Std. SAE Socket	3/8" Dr.
80354	1/2"	6 Pt.	Std. SAE Socket	3/8" Dr.
80355	9/16"	6 Pt.	Std. SAE Socket	3/8" Dr.
80356	5/8"	6 Pt.	Std. SAE Socket	3/8" Dr.
80357	11/16"	6 Pt.	Std. SAE Socket	3/8" Dr.
80358	3/4"	6 Pt.	Std. Metric Socket	3/8" Dr.
80359	13/16"	6 Pt.	Std. SAE Socket	3/8" Dr.
80360	7/8"	6 Pt.	Std. SAE Socket	3/8" Dr.
80361	15/16"	6 Pt.	Std. SAE Socket	3/8" Dr.
80362	1"	6 Pt.	Std. SAE Socket	3/8" Dr.
80363	1/4"	6 Pt.	Deep SAE Socket	3/8" Dr.
80364	5/16"	6 Pt.	Deep SAE Socket	3/8" Dr.
80365	3/8"	6 Pt.	Deep SAE Socket	3/8" Dr.
80366	1/4"	6 Pt.	Deep SAE Socket	3/8" Dr.
80367	7/16"	6 Pt.	Deep SAE Socket	3/8" Dr.
80368	1/2"	6 Pt.	Deep SAE Socket	3/8" Dr.
80369	9/16"	6 Pt.	Deep SAE Socket	3/8" Dr.
80370	5/8"	6 Pt.	Deep SAE Socket	3/8" Dr.
80371	11/16"	6 Pt.	Deep SAE Socket	3/8" Dr.
80372	3/4"	6 Pt.	Deep SAE Socket	3/8" Dr.
80373	7/8"	6 Pt.	Deep SAE Socket	3/8" Dr.
80374	6 mm	6 Pt.	Std. Metric Socket	3/8" Dr.
80375	7 mm	6 Pt.	Std. Metric Socket	3/8" Dr.
80376	8 mm	6 Pt.	Std. Metric Socket	3/8" Dr.
80377	9 mm	6 Pt.	Std. Metric Socket	3/8" Dr.
80378	10 mm	6 Pt.	Std. SAE Socket	3/8" Dr.
80379	11 mm	6 Pt.	Std. Metric Socket	3/8" Dr.
80380	12 mm	6 Pt.	Std. Metric Socket	3/8" Dr.
80381	13 mm	6 Pt.	Std. Metric Socket	3/8" Dr.
80382	14 mm	6 Pt.	Std. Metric Socket	3/8" Dr.
80383	15 mm	6 Pt.	Std. Metric Socket	3/8" Dr.
80384	16 mm	6 Pt.	Std. Metric Socket	3/8" Dr.



Item No.	Description			
80385	17 mm	6 Pt.	Std. Metric Socket	3/8" Dr.
80386	18 mm	6 Pt.	Std. Metric Socket	3/8" Dr.
80387	19 mm	6 Pt.	Std. Metric Socket	3/8" Dr.
80388	6 mm	6 Pt.	Deep Metric Socket	3/8" Dr.
80389	7 mm	6 Pt.	Deep Metric Socket	3/8" Dr.
80390	8 mm	6 Pt.	Deep Metric Socket	3/8" Dr.
80391	9 mm	6 Pt.	Deep Metric Socket	3/8" Dr.
80392	10 mm	6 Pt.	Deep Metric Socket	3/8" Dr.
80393	11 mm	6 Pt.	Deep Metric Socket	3/8" Dr.
80394	12 mm	6 Pt.	Deep Metric Socket	3/8" Dr.
80395	13 mm	6 Pt.	Deep Metric Socket	3/8" Dr.
80396	14 mm	6 Pt.	Deep Metric Socket	3/8" Dr.
80397	15 mm	6 Pt.	Deep Metric Socket	3/8" Dr.
80398	16 mm	6 Pt.	Deep Metric Socket	3/8" Dr.
80399	17 mm	6 Pt.	Deep Metric Socket	3/8" Dr.
80400	18 mm	6 Pt.	Deep Metric Socket	3/8" Dr.
80401	19 mm	6 Pt.	Deep Metric Socket	3/8" Dr.
81241	3" Extension			3/8" Dr.
81242	6" Extension			3/8" Dr.
80549	Universal Joint			3/8" Dr.
81209	Full Polish Stubby Teardrop Ratchet			3/8" Dr.
81211	Full Polish Teardrop Ratchet			3/8" Dr.
80550BM	Replacement Blow Mold Case			

3/8" DRIVE SETS
RATCHETS, SOCKETS & DRIVE TOOLS



80551 - 57 Pc. SAE/METRIC 12 Pt. Standard & Deep Socket Set 3/8" DRIVE

Item No.	Description	
80496	1/4" 12 Pt. Std. SAE Socket	3/8" Dr.
80497	5/16" 12 Pt. Std. SAE Socket	3/8" Dr.
80498	3/8" 12 Pt. Std. SAE Socket	3/8" Dr.
80499	7/16" 12 Pt. Std. SAE Socket	3/8" Dr.
80500	1/2" 12 Pt. Std. SAE Socket	3/8" Dr.
80501	9/16" 12 Pt. Std. SAE Socket	3/8" Dr.
80502	5/8" 12 Pt. Std. SAE Socket	3/8" Dr.
80503	11/16" 12 Pt. Std. SAE Socket	3/8" Dr.
80504	3/4" 12 Pt. Std. SAE Socket	3/8" Dr.
80505	13/16" 12 Pt. Std. SAE Socket	3/8" Dr.
80506	7/8" 12 Pt. Std. SAE Socket	3/8" Dr.
80507	15/16" 12 Pt. Std. SAE Socket	3/8" Dr.
80508	1" 12 Pt. Std. SAE Socket	3/8" Dr.
80509	1/4" 12 Pt. Deep SAE Socket	3/8" Dr.
80510	5/16" 12 Pt. Deep SAE Socket	3/8" Dr.
80511	3/8" 12 Pt. Deep SAE Socket	3/8" Dr.
80512	1/4" 12 Pt. Deep SAE Socket	3/8" Dr.
80513	7/16" 12 Pt. Deep SAE Socket	3/8" Dr.
80514	1/2" 12 Pt. Deep SAE Socket	3/8" Dr.
80515	9/16" 12 Pt. Deep SAE Socket	3/8" Dr.
80516	5/8" 12 Pt. Deep SAE Socket	3/8" Dr.
80517	11/16" 12 Pt. Deep SAE Socket	3/8" Dr.
80518	3/4" 12 Pt. Deep SAE Socket	3/8" Dr.

Item No.	Description	
80519	7/8" 12 Pt. Deep SAE Socket	3/8" Dr.
80482	6 mm 12 Pt. Std. Metric Socket	3/8" Dr.
80483	7 mm 12 Pt. Std. Metric Socket	3/8" Dr.
80484	8 mm 12 Pt. Std. Metric Socket	3/8" Dr.
80485	9 mm 12 Pt. Std. Metric Socket	3/8" Dr.
80486	10 mm 12 Pt. Std. Metric Socket	3/8" Dr.
80487	11 mm 12 Pt. Std. Metric Socket	3/8" Dr.
80488	12 mm 12 Pt. Std. Metric Socket	3/8" Dr.
80489	13 mm 12 Pt. Std. Metric Socket	3/8" Dr.
80490	14 mm 12 Pt. Std. Metric Socket	3/8" Dr.
80491	15 mm 12 Pt. Std. Metric Socket	3/8" Dr.
80492	16 mm 12 Pt. Std. Metric Socket	3/8" Dr.
80493	17 mm 12 Pt. Std. Metric Socket	3/8" Dr.
80494	18 mm 12 Pt. Std. Metric Socket	3/8" Dr.
80495	19 mm 12 Pt. Std. Metric Socket	3/8" Dr.
80520	6 mm 12 Pt. Deep Metric Socket	3/8" Dr.
80521	7 mm 12 Pt. Deep Metric Socket	3/8" Dr.
80522	8 mm 12 Pt. Deep Metric Socket	3/8" Dr.
80523	9 mm 12 Pt. Deep Metric Socket	3/8" Dr.
80524	10 mm 12 Pt. Deep Metric Socket	3/8" Dr.
80525	11 mm 12 Pt. Deep Metric Socket	3/8" Dr.
80526	12 mm 12 Pt. Deep Metric Socket	3/8" Dr.
80527	13 mm 12 Pt. Deep Metric Socket	3/8" Dr.
80528	14 mm 12 Pt. Deep Metric Socket	3/8" Dr.
80529	15 mm 12 Pt. Deep Metric Socket	3/8" Dr.
80530	16 mm 12 Pt. Deep Metric Socket	3/8" Dr.
80531	17 mm 12 Pt. Deep Metric Socket	3/8" Dr.
80532	18 mm 12 Pt. Deep Metric Socket	3/8" Dr.
80533	19 mm 12 Pt. Deep Metric Socket	3/8" Dr.
81241	3" Extension	3/8" Dr.
81242	6" Extension	3/8" Dr.
80549	Universal Joint	3/8" Dr.
81209	Full Polish Stubby Teardrop Ratchet	3/8" Dr.
81211	Full Polish Teardrop Ratchet	3/8" Dr.
80550BM	Replacement Blow Mold Case	

80567 - 39 Pc. SAE 6 Pt. Standard & Deep Socket Set 3/8" DRIVE

Item No.	Description			
80350	1/4"	6 Pt.	Std. SAE Socket	3/8" Dr.
80351	5/16"	6 Pt.	Std. SAE Socket	3/8" Dr.
80352	3/8"	6 Pt.	Std. SAE Socket	3/8" Dr.
80353	7/16"	6 Pt.	Std. SAE Socket	3/8" Dr.
80354	1/2"	6 Pt.	Std. SAE Socket	3/8" Dr.
80355	9/16"	6 Pt.	Std. SAE Socket	3/8" Dr.
80356	5/8"	6 Pt.	Std. SAE Socket	3/8" Dr.
80357	11/16"	6 Pt.	Std. SAE Socket	3/8" Dr.
80358	3/4"	6 Pt.	Std. SAE Socket	3/8" Dr.
80359	13/16"	6 Pt.	Std. SAE Socket	3/8" Dr.
80360	7/8"	6 Pt.	Std. SAE Socket	3/8" Dr.
80361	15/16"	6 Pt.	Std. SAE Socket	3/8" Dr.
80362	1"	6 Pt.	Std. SAE Socket	3/8" Dr.
80363	1/4"	6 Pt.	Deep SAE Socket	3/8" Dr.
80364	5/16"	6 Pt.	Deep SAE Socket	3/8" Dr.
80365	3/8"	6 Pt.	Deep SAE Socket	3/8" Dr.
80366	1/4"	6 Pt.	Deep SAE Socket	3/8" Dr.
80367	7/16"	6 Pt.	Deep SAE Socket	3/8" Dr.
80368	1/2"	6 Pt.	Deep SAE Socket	3/8" Dr.
80369	9/16"	6 Pt.	Deep SAE Socket	3/8" Dr.
80370	5/8"	6 Pt.	Deep SAE Socket	3/8" Dr.
80371	11/16"	6 Pt.	Deep SAE Socket	3/8" Dr.
80372	3/4"	6 Pt.	Deep SAE Socket	3/8" Dr.
80373	7/8"	6 Pt.	Deep SAE Socket	3/8" Dr.



Item No.	Description			
80592	15/16"	6 Pt.	Deep SAE Socket	3/8" Dr.
80593	1"	6 Pt.	Deep SAE Socket	3/8" Dr.
81211	Full Polish Teardrop Ratchet			3/8" Dr.
81241	3" Extension			3/8" Dr.
81242	6" Extension			3/8" Dr.
81243	10" Extension			3/8" Dr.
80549	Universal Joint			3/8" Dr.
81221	Full Polish Flex Handle			3/8" Dr.
80414	1/8"		Hex Bit Socket	3/8" Dr.
80416	5/32"		Hex Bit Socket	3/8" Dr.
80417	3/16"		Hex Bit Socket	3/8" Dr.
80418	7/32"		Hex Bit Socket	3/8" Dr.
80419	1/4"		Hex Bit Socket	3/8" Dr.
80420	5/16"		Hex Bit Socket	3/8" Dr.
80421	3/8"		Hex Bit Socket	3/8" Dr.

3/8" DRIVE SETS
RATCHETS, SOCKETS & DRIVE TOOLS



80566 - 39 Pc. SAE 12 Pt. Standard & Deep Socket Set 3/8" DRIVE

Item No.	Description		
80496	1/4"	12 Pt. Std. SAE Socket	3/8" Dr.
80497	5/16"	12 Pt. Std. SAE Socket	3/8" Dr.
80498	3/8"	12 Pt. Std. SAE Socket	3/8" Dr.
80499	7/16"	12 Pt. Std. SAE Socket	3/8" Dr.
80500	1/2"	12 Pt. Std. SAE Socket	3/8" Dr.
80501	9/16"	12 Pt. Std. SAE Socket	3/8" Dr.
80502	5/8"	12 Pt. Std. SAE Socket	3/8" Dr.
80503	11/16"	12 Pt. Std. SAE Socket	3/8" Dr.
80504	3/4"	12 Pt. Std. SAE Socket	3/8" Dr.
80505	13/16"	12 Pt. Std. SAE Socket	3/8" Dr.
80506	7/8"	12 Pt. Std. SAE Socket	3/8" Dr.
80507	15/16"	12 Pt. Std. SAE Socket	3/8" Dr.
80508	1"	12 Pt. Std. SAE Socket	3/8" Dr.
80509	1/4"	12 Pt. Deep SAE Socket	3/8" Dr.

Item No.	Description		
80510	5/16"	12 Pt. Deep SAE Socket	3/8" Dr.
80511	3/8"	12 Pt. Deep SAE Socket	3/8" Dr.
80512	1/4"	12 Pt. Deep SAE Socket	3/8" Dr.
80513	7/16"	12 Pt. Deep SAE Socket	3/8" Dr.
80514	1/2"	12 Pt. Deep SAE Socket	3/8" Dr.
80515	9/16"	12 Pt. Deep SAE Socket	3/8" Dr.
80516	5/8"	12 Pt. Deep SAE Socket	3/8" Dr.
80517	11/16"	12 Pt. Deep SAE Socket	3/8" Dr.
80518	3/4"	12 Pt. Deep SAE Socket	3/8" Dr.
80519	7/8"	12 Pt. Deep SAE Socket	3/8" Dr.
81211	Full Polish Teardrop Ratchet		3/8" Dr.
81241	3" Extension		3/8" Dr.
81242	6" Extension		3/8" Dr.
81243	10" Extension		3/8" Dr.
80549	Universal Joint		3/8" Dr.
81221	3/8" Dr. Full Polish Flex Handle		
80414	1/8"	Hex Bit Socket	3/8" Dr.
80416	5/32"	Hex Bit Socket	3/8" Dr.
80417	3/16"	Hex Bit Socket	3/8" Dr.
80418	7/32"	Hex Bit Socket	3/8" Dr.
80419	1/4"	Hex Bit Socket	3/8" Dr.
80420	5/16"	Hex Bit Socket	3/8" Dr.
80421	3/8"	Hex Bit Socket	3/8" Dr.

80569 - 30 Pc. SAE 6 Pt. Standard & Deep Socket Set 3/8" DRIVE

Item No.	Description			
80350	1/4"	6 Pt.	Std. SAE Socket	3/8" Dr.
80351	5/16"	6 Pt.	Std. SAE Socket	3/8" Dr.
80352	3/8"	6 Pt.	Std. SAE Socket	3/8" Dr.
80353	7/16"	6 Pt.	Std. SAE Socket	3/8" Dr.
80354	1/2"	6 Pt.	Std. SAE Socket	3/8" Dr.
80355	9/16"	6 Pt.	Std. SAE Socket	3/8" Dr.
80356	5/8"	6 Pt.	Std. SAE Socket	3/8" Dr.
80357	11/16"	6 Pt.	Std. SAE Socket	3/8" Dr.
80358	3/4"	6 Pt.	Std. SAE Socket	3/8" Dr.
80359	13/16"	6 Pt.	Std. SAE Socket	3/8" Dr.
80360	7/8"	6 Pt.	Std. SAE Socket	3/8" Dr.
80361	15/16"	6 Pt.	Std. SAE Socket	3/8" Dr.
80362	1"	6 Pt.	Std. SAE Socket	3/8" Dr.
80363	1/4"	6 Pt.	Deep SAE Socket	3/8" Dr.
80364	5/16"	6 Pt.	Deep SAE Socket	3/8" Dr.
80365	3/8"	6 Pt.	Deep SAE Socket	3/8" Dr.
80366	1/4"	6 Pt.	Deep SAE Socket	3/8" Dr.



Item No.	Description			
80367	7/16"	6 Pt.	Deep SAE Socket	3/8" Dr.
80368	1/2"	6 Pt.	Deep SAE Socket	3/8" Dr.
80369	9/16"	6 Pt.	Deep SAE Socket	3/8" Dr.
80370	5/8"	6 Pt.	Deep SAE Socket	3/8" Dr.
80371	11/16"	6 Pt.	Deep SAE Socket	3/8" Dr.
80372	3/4"	6 Pt.	Deep SAE Socket	3/8" Dr.
80373	7/8"	6 Pt.	Deep SAE Socket	3/8" Dr.
80592	15/16"	6 Pt.	Deep SAE Socket	3/8" Dr.
80593	1"	6 Pt.	Deep SAE Socket	3/8" Dr.
81211	Full Polish Teardrop Ratchet			3/8" Dr.
81241	3" Extension			3/8" Dr.
81242	6" Extension			3/8" Dr.
80549	Universal Joint			3/8" Dr.

80568 - 30 Pc. SAE 12 Pt. Standard & Deep Socket Set 3/8" DRIVE

Item No.	Description			
80496	1/4"	12 Pt.	Std. SAE Socket	3/8" Dr.
80497	5/16"	12 Pt.	Std. SAE Socket	3/8" Dr.
80498	3/8"	12 Pt.	Std. SAE Socket	3/8" Dr.
80499	7/16"	12 Pt.	Std. SAE Socket	3/8" Dr.
80500	1/2"	12 Pt.	Std. SAE Socket	3/8" Dr.
80501	9/16"	12 Pt.	Std. SAE Socket	3/8" Dr.
80502	5/8"	12 Pt.	Std. SAE Socket	3/8" Dr.
80503	11/16"	12 Pt.	Std. SAE Socket	3/8" Dr.
80504	3/4"	12 Pt.	Std. SAE Socket	3/8" Dr.
80505	13/16"	12 Pt.	Std. SAE Socket	3/8" Dr.
80506	7/8"	12 Pt.	Std. SAE Socket	3/8" Dr.
80507	15/16"	12 Pt.	Std. SAE Socket	3/8" Dr.
80508	1"	12 Pt.	Std. SAE Socket	3/8" Dr.
80509	1/4"	12 Pt.	Deep SAE Socket	3/8" Dr.
80510	5/16"	12 Pt.	Deep SAE Socket	3/8" Dr.
80511	3/8"	12 Pt.	Deep SAE Socket	3/8" Dr.
80512	1/4"	12 Pt.	Deep SAE Socket	3/8" Dr.



Item No.	Description			
80513	7/16"	12 Pt.	Deep SAE Socket	3/8" Dr.
80514	1/2"	12 Pt.	Deep SAE Socket	3/8" Dr.
80515	9/16"	12 Pt.	Deep SAE Socket	3/8" Dr.
80516	5/8"	12 Pt.	Deep SAE Socket	3/8" Dr.
80517	11/16"	12 Pt.	Deep SAE Socket	3/8" Dr.
80518	3/4"	12 Pt.	Deep SAE Socket	3/8" Dr.
80519	7/8"	12 Pt.	Deep SAE Socket	3/8" Dr.
80594	15/16"	12 Pt.	Deep SAE Socket	3/8" Dr.
80595	1"	12 Pt.	Deep SAE Socket	3/8" Dr.
81211	Full Polish Teardrop Ratchet			3/8" Dr.
81241	3" Extension			3/8" Dr.
81242	6" Extension			3/8" Dr.
80549	Universal Joint			3/8" Dr.



80557 - 21 Pc. SAE 6 Pt. & 12 Pt. Standard & Deep Socket Set 3/8" DRIVE

Item No.	Description			
80365	3/8"	6 Pt.	Deep SAE Socket	3/8" Dr.
80366	1/4"	6 Pt.	Deep SAE Socket	3/8" Dr.
80367	7/16"	6 Pt.	Std. SAE Socket	3/8" Dr.
80368	1/2"	6 Pt.	Deep SAE Socket	3/8" Dr.
80369	9/16"	6 Pt.	Deep SAE Socket	3/8" Dr.
80370	5/8"	6 Pt.	Deep SAE Socket	3/8" Dr.
80371	11/16"	6 Pt.	Deep SAE Socket	3/8" Dr.

Item No.	Description			
80372	3/4"	6 Pt.	Deep SAE Socket	3/8" Dr.
80373	7/8"	6 Pt.	Deep SAE Socket	3/8" Dr.
80496	1/4"	12 Pt.	Std. SAE Socket	3/8" Dr.
80497	5/16"	12 Pt.	Std. SAE Socket	3/8" Dr.
80498	3/8"	12 Pt.	Std. SAE Socket	3/8" Dr.
80499	7/16"	12 Pt.	Std. SAE Socket	3/8" Dr.
80500	1/2"	12 Pt.	Std. SAE Socket	3/8" Dr.
80501	9/16"	12 Pt.	Std. SAE Socket	3/8" Dr.
80502	5/8"	12 Pt.	Std. SAE Socket	3/8" Dr.
80503	11/16"	12 Pt.	Std. SAE Socket	3/8" Dr.
80504	3/4"	12 Pt.	Std. SAE Socket	3/8" Dr.
81241	3" Extension			3/8" Dr.
81242	6" Extension			3/8" Dr.
81211	Full Polish Teardrop Ratchet			3/8" Dr.



80559 - 24 Pc. METRIC 6 Pt. & 12 Pt. Standard & Deep Socket Set 3/8" DRIVE

Item No.	Description			
80392	10 mm	6 Pt.	Deep Metric Socket	3/8" Dr.
80393	11 mm	6 Pt.	Deep Metric Socket	3/8" Dr.
80394	12 mm	6 Pt.	Deep Metric Socket	3/8" Dr.
80395	13 mm	6 Pt.	Std. Metric Socket	3/8" Dr.
80396	14 mm	6 Pt.	Std. Metric Socket	3/8" Dr.
80397	15 mm	6 Pt.	Deep Metric Socket	3/8" Dr.
80398	16 mm	6 Pt.	Deep Metric Socket	3/8" Dr.
80399	17 mm	6 Pt.	Deep Metric Socket	3/8" Dr.

Item No.	Description			
80400	18 mm	6 Pt.	Deep Metric Socket	3/8" Dr.
80484	8 mm	12 Pt.	Std. Metric Socket	3/8" Dr.
80485	9 mm	12 Pt.	Std. Metric Socket	3/8" Dr.
80486	10 mm	12 Pt.	Std. Metric Socket	3/8" Dr.
80487	11 mm	12 Pt.	Std. Metric Socket	3/8" Dr.
80488	12 mm	12 Pt.	Std. Metric Socket	3/8" Dr.
80489	13 mm	12 Pt.	Std. Metric Socket	3/8" Dr.
80490	14 mm	12 Pt.	Std. Metric Socket	3/8" Dr.
80491	15 mm	12 Pt.	Deep Metric Socket	3/8" Dr.
80492	16 mm	12 Pt.	Std. Metric Socket	3/8" Dr.
80493	17 mm	12 Pt.	Std. Metric Socket	3/8" Dr.
80494	18 mm	12 Pt.	Std. Metric Socket	3/8" Dr.
80495	19 mm	12 Pt.	Std. Metric Socket	3/8" Dr.
81241	3" Extension			3/8" Dr.
81242	6" Extension			3/8" Dr.
81211	Full Polish Teardrop Ratchet			3/8" Dr.

**80591 - 20 Pt. METRIC 6 Pt. Standard Socket Set
3/8" DRIVE**

Item No.	Description
80374	6 mm 6 Pt. Std. Metric Socket 3/8" Dr.
80375	7 mm 6 Pt. Std. Metric Socket 3/8" Dr.
80376	8 mm 6 Pt. Std. Metric Socket 3/8" Dr.
80377	9 mm 6 Pt. Std. Metric Socket 3/8" Dr.
80378	10 mm 6 Pt. Std. Metric Socket 3/8" Dr.
80379	11 mm 6 Pt. Std. Metric Socket 3/8" Dr.
80380	12 mm 6 Pt. Std. Metric Socket 3/8" Dr.
80381	13 mm 6 Pt. Std. Metric Socket 3/8" Dr.
80382	14 mm 6 Pt. Std. Metric Socket 3/8" Dr.
80383	15 mm 6 Pt. Std. Metric Socket 3/8" Dr.
80384	16 mm 6 Pt. Std. Metric Socket 3/8" Dr.
80385	17 mm 6 Pt. Std. Metric Socket 3/8" Dr.
80386	18 mm 6 Pt. Std. Metric Socket 3/8" Dr.



Item No.	Description
80387	19 mm 6 Pt. Std. Metric Socket 3/8" Dr.
80330	20 mm 6 Pt. Std. Metric Socket 3/8" Dr.
80331	21 mm 6 Pt. Std. Metric Socket 3/8" Dr.
80332	22 mm 6 Pt. Std. Metric Socket 3/8" Dr.
81211	Full Polish Teardrop Ratchet 3/8" Dr.
81241	3" Extension 3/8" Dr.
81242	6" Extension 3/8" Dr.

**80590 - 20 Pt. METRIC 12 Pt. Standard Socket Set
3/8" DRIVE**

Item No.	Description
80482	6 mm 12 Pt. Std. Metric Socket 3/8" Dr.
80483	7 mm 12 Pt. Std. Metric Socket 3/8" Dr.
80484	8 mm 12 Pt. Std. Metric Socket 3/8" Dr.
80485	9 mm 12 Pt. Std. Metric Socket 3/8" Dr.
80486	10 mm 12 Pt. Std. Metric Socket 3/8" Dr.
80487	11 mm 12 Pt. Std. Metric Socket 3/8" Dr.
80488	12 mm 12 Pt. Std. Metric Socket 3/8" Dr.
80489	13 mm 12 Pt. Std. Metric Socket 3/8" Dr.
80490	14 mm 12 Pt. Std. Metric Socket 3/8" Dr.
80491	15 mm 12 Pt. Std. Metric Socket 3/8" Dr.
80492	16 mm 12 Pt. Std. Metric Socket 3/8" Dr.
80493	17 mm 12 Pt. Std. Metric Socket 3/8" Dr.
80494	18 mm 12 Pt. Std. Metric Socket 3/8" Dr.
80495	19 mm 12 Pt. Std. Metric Socket 3/8" Dr.



Item No.	Description
80596	20 mm 12 Pt. Std. Metric Socket 3/8" Dr.
80597	21 mm 12 Pt. Std. Metric Socket 3/8" Dr.
80598	22 mm 12 Pt. Std. Metric Socket 3/8" Dr.
81211	Full Polish Teardrop Ratchet 3/8" Dr.
81241	3" Extension 3/8" Dr.
81242	6" Extension 3/8" Dr.

**3/8" DRIVE SETS
RATCHETS, SOCKETS & DRIVE TOOLS**



**80589 - 16 Pc. SAE 6 Pt. Standard Socket Set
3/8" DRIVE**

Item No.	Description			
80354	1/2"	6 Pt.	Std. SAE Socket	3/8" Dr.
80355	9/16"	6 Pt.	Std. SAE Socket	3/8" Dr.
80356	5/8"	6 Pt.	Std. SAE Socket	3/8" Dr.
80357	11/16"	6 Pt.	Std. SAE Socket	3/8" Dr.
80358	3/4"	6 Pt.	Std. SAE Socket	3/8" Dr.
80359	13/16"	6 Pt.	Std. SAE Socket	3/8" Dr.
80360	7/8"	6 Pt.	Std. SAE Socket	3/8" Dr.
80361	15/16"	6 Pt.	Std. SAE Socket	3/8" Dr.
80362	1"	6 Pt.	Std. SAE Socket	3/8" Dr.
81211	Full Polish Teardrop Ratchet			3/8" Dr.
81241	3" Extension			3/8" Dr.
81242	6" Extension			3/8" Dr.

Item No.	Description			
80350	1/4"	6 Pt.	Std. SAE Socket	3/8" Dr.
80351	5/16"	6 Pt.	Std. SAE Socket	3/8" Dr.
80352	3/8"	6 Pt.	Std. SAE Socket	3/8" Dr.
80353	7/16"	6 Pt.	Std. SAE Socket	3/8" Dr.



**80584 - 16 Pc. SAE 12 Pt. Standard Socket Set
3/8" DRIVE**

Item No.	Description			
80500	1/2"	12 Pt.	Std. SAE Socket	3/8" Dr.
80501	9/16"	12 Pt.	Std. SAE Socket	3/8" Dr.
80502	5/8"	12 Pt.	Std. SAE Socket	3/8" Dr.
80503	11/16"	12 Pt.	Std. SAE Socket	3/8" Dr.
80504	3/4"	12 Pt.	Std. SAE Socket	3/8" Dr.
80505	13/16"	12 Pt.	Std. SAE Socket	3/8" Dr.
80506	7/8"	12 Pt.	Std. SAE Socket	3/8" Dr.
80507	15/16"	12 Pt.	Std. SAE Socket	3/8" Dr.
80508	1"	12 Pt.	Std. SAE Socket	3/8" Dr.
81211	Full Polish Teardrop Ratchet			3/8" Dr.
81241	3" Extension			3/8" Dr.
81242	6" Extension			3/8" Dr.

Item No.	Description			
80496	1/4"	12 Pt.	Std. SAE Socket	3/8" Dr.
80497	5/16"	12 Pt.	Std. SAE Socket	3/8" Dr.
80498	3/8"	12 Pt.	Std. SAE Socket	3/8" Dr.
80499	7/16"	12 Pt.	Std. SAE Socket	3/8" Dr.

**80556 - 12 Pc. SAE 6 Pt. Standard Socket Set
3/8" DRIVE**

Item No.	Description		
80352	3/8"	6 Pt.	Std. SAE Socket 3/8" Dr.
80353	7/16"	6 Pt.	Std. SAE Socket 3/8" Dr.
80354	1/2"	6 Pt.	Std. SAE Socket 3/8" Dr.
80355	9/16"	6 Pt.	Std. SAE Socket 3/8" Dr.
80356	5/8"	6 Pt.	Std. SAE Socket 3/8" Dr.
80357	11/16"	6 Pt.	Std. SAE Socket 3/8" Dr.
80358	3/4"	6 Pt.	Std. SAE Socket 3/8" Dr.
80359	13/16"	12 Pt.	Std. SAE Socket 3/8" Dr.
80360	7/8"	6 Pt.	Std. SAE Socket 3/8" Dr.
81241	3" Extension		3/8" Dr.



Item No.	Description	
81242	6" Extension	3/8" Dr.
81211	Full Polish Teardrop Ratchet	3/8" Dr.

**80558 - 13 Pc. METRIC 6 Pt. Standard Socket Set
3/8" DRIVE**

Item No.	Description		
80376	8 mm	6 Pt.	Std. Metric Socket 3/8" Dr.
80377	9 mm	6 Pt.	Std. Metric Socket 3/8" Dr.
80378	10 mm	6 Pt.	Std. Metric Socket 3/8" Dr.
80379	11 mm	6 Pt.	Std. Metric Socket 3/8" Dr.
80380	12 mm	6 Pt.	Std. Metric Socket 3/8" Dr.
80381	13 mm	6 Pt.	Std. Metric Socket 3/8" Dr.
80382	14 mm	6 Pt.	Std. Metric Socket 3/8" Dr.
80383	15 mm	6 Pt.	Std. Metric Socket 3/8" Dr.
80384	16 mm	6 Pt.	Std. Metric Socket 3/8" Dr.
80385	17 mm	6 Pt.	Std. Metric Socket 3/8" Dr.



Item No.	Description	
81241	3" Extension	3/8" Dr.
81242	6" Extension	3/8" Dr.
81211	Full Polish Teardrop Ratchet	3/8" Dr.

80718 - 63 Pc. SAE/METRIC 6 Pt. Master Socket Accessory Set 3/8" DRIVE

Item No. Description

80350	1/4"	6 Pt.	Std. SAE Socket	3/8" Dr.
80351	5/16"	6 Pt.	Std. SAE Socket	3/8" Dr.
80352	3/8"	6 Pt.	Std. SAE Socket	3/8" Dr.
80353	7/16"	6 Pt.	Std. SAE Socket	3/8" Dr.
80354	1/2"	6 Pt.	Std. SAE Socket	3/8" Dr.
80355	9/16"	6 Pt.	Std. SAE Socket	3/8" Dr.
80356	5/8"	6 Pt.	Std. SAE Socket	3/8" Dr.
80357	11/16"	6 Pt.	Std. SAE Socket	3/8" Dr.
80358	3/4"	6 Pt.	Std. SAE Socket	3/8" Dr.
80359	13/16"	6 Pt.	Std. SAE Socket	3/8" Dr.
80360	7/8"	6 Pt.	Std. SAE Socket	3/8" Dr.
80361	15/16"	6 Pt.	Std. SAE Socket	3/8" Dr.
80362	1"	6 Pt.	Std. SAE Socket	3/8" Dr.
80374	6 mm	6 Pt.	Std. Metric Socket	3/8" Dr.
80375	7 mm	6 Pt.	Std. Metric Socket	3/8" Dr.
80376	8 mm	6 Pt.	Std. Metric Socket	3/8" Dr.
80377	9 mm	6 Pt.	Std. Metric Socket	3/8" Dr.
80378	10 mm	6 Pt.	Std. Metric Socket	3/8" Dr.
80379	11 mm	6 Pt.	Std. Metric Socket	3/8" Dr.
80380	12 mm	6 Pt.	Std. Metric Socket	3/8" Dr.
80381	13 mm	6 Pt.	Std. Metric Socket	3/8" Dr.
80382	14 mm	6 Pt.	Std. Metric Socket	3/8" Dr.
80383	15 mm	6 Pt.	Std. Metric Socket	3/8" Dr.
80384	16 mm	6 Pt.	Std. Metric Socket	3/8" Dr.
80385	17 mm	6 Pt.	Std. Metric Socket	3/8" Dr.
80386	18 mm	6 Pt.	Std. Metric Socket	3/8" Dr.
80387	19 mm	6 Pt.	Std. Metric Socket	3/8" Dr.
80330	20 mm	6 Pt.	Std. Metric Socket	3/8" Dr.
80331	21 mm	6 Pt.	Std. Metric Socket	3/8" Dr.
80332	22 mm	6 Pt.	Std. Metric Socket	3/8" Dr.
80363	1/4"	6 Pt.	Deep SAE Socket	3/8" Dr.
80364	5/16"	6 Pt.	Deep SAE Socket	3/8" Dr.
80365	3/8"	6 Pt.	Deep SAE Socket	3/8" Dr.
80366	1/4"	6 Pt.	Deep SAE Socket	3/8" Dr.
80367	7/16"	6 Pt.	Deep SAE Socket	3/8" Dr.



Item No. Description

80368	1/2"	6 Pt.	Deep SAE Socket	3/8" Dr.
80369	9/16"	6 Pt.	Deep SAE Socket	3/8" Dr.
80370	5/8"	6 Pt.	Deep SAE Socket	3/8" Dr.
80371	11/16"	6 Pt.	Deep SAE Socket	3/8" Dr.
80372	3/4"	6 Pt.	Deep SAE Socket	3/8" Dr.
80373	7/8"	6 Pt.	Deep SAE Socket	3/8" Dr.
80592	15/16"	6 Pt.	Deep SAE Socket	3/8" Dr.
80593	1"	6 Pt.	Deep SAE Socket	3/8" Dr.
80388	6 mm	6 Pt.	Deep Metric Socket	3/8" Dr.
80389	7 mm	6 Pt.	Deep Metric Socket	3/8" Dr.
80390	8 mm	6 Pt.	Deep Metric Socket	3/8" Dr.
80391	9 mm	6 Pt.	Deep Metric Socket	3/8" Dr.
80392	10 mm	6 Pt.	Deep Metric Socket	3/8" Dr.
80393	11 mm	6 Pt.	Deep Metric Socket	3/8" Dr.
80394	12 mm	6 Pt.	Deep Metric Socket	3/8" Dr.
80395	13 mm	6 Pt.	Deep Metric Socket	3/8" Dr.
80396	14 mm	6 Pt.	Deep Metric Socket	3/8" Dr.
80397	15 mm	6 Pt.	Deep Metric Socket	3/8" Dr.
80398	16 mm	6 Pt.	Deep Metric Socket	3/8" Dr.
80399	17 mm	6 Pt.	Deep Metric Socket	3/8" Dr.
80400	18 mm	6 Pt.	Deep Metric Socket	3/8" Dr.
80401	19 mm	6 Pt.	Deep Metric Socket	3/8" Dr.
80406	20 mm	6 Pt.	Deep Metric Socket	3/8" Dr.
80407	21 mm	6 Pt.	Deep Metric Socket	3/8" Dr.
80408	22 mm	6 Pt.	Deep Metric Socket	3/8" Dr.
80409	24 mm	6 Pt.	Deep Metric Socket	3/8" Dr.
80402	5/8"		Spark Plug Socket	3/8" Dr.
80403	13/16"		Spark Plug Socket	3/8" Dr.

**80553 - 13 Pc. SAE 6 Pt. Standard Socket Set
3/8" DRIVE**

Item No.	Description			
80350	1/4"	6 Pt.	Std. SAE Socket	3/8" Dr.
80351	5/16"	6 Pt.	Std. SAE Socket	3/8" Dr.
80352	3/8"	6 Pt.	Std. SAE Socket	3/8" Dr.
80353	7/16"	6 Pt.	Std. SAE Socket	3/8" Dr.
80354	1/2"	6 Pt.	Std. SAE Socket	3/8" Dr.
80355	9/16"	6 Pt.	Std. SAE Socket	3/8" Dr.
80356	5/8"	6 Pt.	Std. SAE Socket	3/8" Dr.

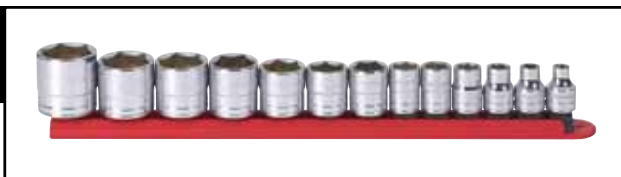

80357	11/16"	6 Pt.	Std. SAE Socket	3/8" Dr.
80358	3/4"	6 Pt.	Std. SAE Socket	3/8" Dr.
80359	13/16"	6 Pt.	Std. SAE Socket	3/8" Dr.
80360	7/8"	6 Pt.	Std. SAE Socket	3/8" Dr.
80361	15/16"	6 Pt.	Std. SAE Socket	3/8" Dr.
80362	1"	6 Pt.	Std. SAE Socket	3/8" Dr.

**80561 - 13 Pc. SAE 12 Pt. Standard Socket Set
3/8" DRIVE**

Item No.	Description			
80496	1/4"	12 Pt.	Std. SAE Socket	3/8" Dr.
80497	5/16"	12 Pt.	Std. SAE Socket	3/8" Dr.
80498	3/8"	12 Pt.	Std. SAE Socket	3/8" Dr.
80499	7/16"	12 Pt.	Std. SAE Socket	3/8" Dr.
80500	1/2"	12 Pt.	Std. SAE Socket	3/8" Dr.
80501	9/16"	12 Pt.	Std. SAE Socket	3/8" Dr.
80502	5/8"	12 Pt.	Std. SAE Socket	3/8" Dr.



80503	11/16"	12 Pt.	Std. SAE Socket	3/8" Dr.
80504	3/4"	12 Pt.	Std. SAE Socket	3/8" Dr.
80505	13/16"	12 Pt.	Std. SAE Socket	3/8" Dr.
80506	7/8"	12 Pt.	Std. SAE Socket	3/8" Dr.
80507	15/16"	12 Pt.	Std. SAE Socket	3/8" Dr.
80508	1"	12 Pt.	Std. SAE Socket	3/8" Dr.

**80555 - 11 Pc. SAE 6 Pt. Deep Socket Set
3/8" DRIVE**

Item No.	Description			
80363	1/4"	6 Pt.	Deep SAE Socket	3/8" Dr.
80364	5/16"	6 Pt.	Deep SAE Socket	3/8" Dr.
80365	3/8"	6 Pt.	Deep SAE Socket	3/8" Dr.
80366	1/4"	6 Pt.	Deep SAE Socket	3/8" Dr.
80367	7/16"	6 Pt.	Deep SAE Socket	3/8" Dr.
80368	1/2"	6 Pt.	Deep SAE Socket	3/8" Dr.
80369	9/16"	6 Pt.	Deep SAE Socket	3/8" Dr.



80370	5/8"	6 Pt.	Deep SAE Socket	3/8" Dr.
80371	11/16"	6 Pt.	Deep SAE Socket	3/8" Dr.
80372	3/4"	6 Pt.	Deep SAE Socket	3/8" Dr.
80373	7/8"	6 Pt.	Deep SAE Socket	3/8" Dr.



**80563 - 11 Pc. SAE 12 Pt. Deep Socket Set
3/8" DRIVE**

Item No.	Description			
80509	1/4"	12 Pt.	Deep SAE Socket	3/8" Dr.
80510	5/16"	12 Pt.	Deep SAE Socket	3/8" Dr.
80511	3/8"	12 Pt.	Deep SAE Socket	3/8" Dr.
80512	1/4"	12 Pt.	Deep SAE Socket	3/8" Dr.
80513	7/16"	12 Pt.	Deep SAE Socket	3/8" Dr.
80514	1/2"	12 Pt.	Deep SAE Socket	3/8" Dr.
80515	9/16"	12 Pt.	Deep SAE Socket	3/8" Dr.

80516	5/8"	12 Pt.	Deep SAE Socket	3/8" Dr.
80517	11/16"	12 Pt.	Deep SAE Socket	3/8" Dr.
80518	3/4"	12 Pt.	Deep SAE Socket	3/8" Dr.
80519	7/8"	12 Pt.	Deep SAE Socket	3/8" Dr.



**80552 - 14 Pc. METRIC 6 Pt. Standard Socket Set
3/8" DRIVE**

Item No.	Description			
80374	6 mm	6 Pt.	Std. Metric Socket	3/8" Dr.
80375	7 mm	6 Pt.	Std. Metric Socket	3/8" Dr.
80376	8 mm	6 Pt.	Std. Metric Socket	3/8" Dr.
80377	9 mm	6 Pt.	Std. Metric Socket	3/8" Dr.
80378	10 mm	6 Pt.	Std. Metric Socket	3/8" Dr.
80379	11 mm	6 Pt.	Std. Metric Socket	3/8" Dr.
80380	12 mm	6 Pt.	Std. Metric Socket	3/8" Dr.

80381	13 mm	6 Pt.	Std. Metric Socket	3/8" Dr.
80382	14 mm	6 Pt.	Std. Metric Socket	3/8" Dr.
80383	15 mm	6 Pt.	Std. Metric Socket	3/8" Dr.
80384	16 mm	6 Pt.	Std. Metric Socket	3/8" Dr.
80385	17 mm	6 Pt.	Std. Metric Socket	3/8" Dr.
80386	18 mm	6 Pt.	Std. Metric Socket	3/8" Dr.
80387	19 mm	6 Pt.	Std. Metric Socket	3/8" Dr.



**80560 - 14 Pc. METRIC 12 Pt. Standard Socket Set
3/8" DRIVE**

Item No.	Description			
80482	6 mm	12 Pt.	Std. Metric Socket	3/8" Dr.
80483	7 mm	12 Pt.	Std. Metric Socket	3/8" Dr.
80484	8 mm	12 Pt.	Std. Metric Socket	3/8" Dr.
80485	9 mm	12 Pt.	Std. Metric Socket	3/8" Dr.
80486	10 mm	12 Pt.	Std. Metric Socket	3/8" Dr.
80487	11 mm	12 Pt.	Std. Metric Socket	3/8" Dr.
80488	12 mm	12 Pt.	Std. Metric Socket	3/8" Dr.

80489	13 mm	12 Pt.	Std. Metric Socket	3/8" Dr.
80490	14 mm	12 Pt.	Std. Metric Socket	3/8" Dr.
80491	15 mm	12 Pt.	Std. Metric Socket	3/8" Dr.
80492	16 mm	12 Pt.	Std. Metric Socket	3/8" Dr.
80493	17 mm	12 Pt.	Std. Metric Socket	3/8" Dr.
80494	18 mm	12 Pt.	Std. Metric Socket	3/8" Dr.
80495	19 mm	12 Pt.	Std. Metric Socket	3/8" Dr.

**80554 - 14 Pc. METRIC 6 Pt. Deep Socket Set
3/8" DRIVE**

Item No.	Description			
80388	6 mm	6 Pt.	Deep Metric Socket	3/8" Dr.
80389	7 mm	6 Pt.	Deep Metric Socket	3/8" Dr.
80390	8 mm	6 Pt.	Deep Metric Socket	3/8" Dr.
80391	9 mm	6 Pt.	Deep Metric Socket	3/8" Dr.
80392	10 mm	6 Pt.	Deep Metric Socket	3/8" Dr.
80393	11 mm	6 Pt.	Deep Metric Socket	3/8" Dr.
80394	12 mm	6 Pt.	Deep Metric Socket	3/8" Dr.
80395	13 mm	6 Pt.	Deep Metric Socket	3/8" Dr.



80396	14 mm	6 Pt.	Deep Metric Socket	3/8" Dr.
80397	15 mm	6 Pt.	Deep Metric Socket	3/8" Dr.
80398	16 mm	6 Pt.	Deep Metric Socket	3/8" Dr.
80399	17 mm	6 Pt.	Deep Metric Socket	3/8" Dr.
80400	18 mm	6 Pt.	Deep Metric Socket	3/8" Dr.
80401	19 mm	6 Pt.	Deep Metric Socket	3/8" Dr.

**80562 - 14 Pc. METRIC 12 Pt. Deep Socket Set
3/8" DRIVE**

Item No.	Description			
80520	6 mm	12 Pt.	Deep Metric Socket	3/8" Dr.
80521	7 mm	12 Pt.	Deep Metric Socket	3/8" Dr.
80522	8 mm	12 Pt.	Deep Metric Socket	3/8" Dr.
80523	9 mm	12 Pt.	Deep Metric Socket	3/8" Dr.
80524	10 mm	12 Pt.	Deep Metric Socket	3/8" Dr.
80525	11 mm	12 Pt.	Deep Metric Socket	3/8" Dr.
80526	12 mm	12 Pt.	Deep Metric Socket	3/8" Dr.
80527	13 mm	12 Pt.	Deep Metric Socket	3/8" Dr.



80528	14 mm	12 Pt.	Deep Metric Socket	3/8" Dr.
80529	15 mm	12 Pt.	Deep Metric Socket	3/8" Dr.
80530	16 mm	12 Pt.	Deep Metric Socket	3/8" Dr.
80531	17 mm	12 Pt.	Deep Metric Socket	3/8" Dr.
80532	18 mm	12 Pt.	Deep Metric Socket	3/8" Dr.
80533	19 mm	12 Pt.	Deep Metric Socket	3/8" Dr.

**80564 - 7 Pc. SAE 6 Pt. Flex Socket Set
3/8" DRIVE**

Item No.	Description			
80343	3/8"	6 Pt.	Flex SAE Socket	3/8" Dr.
80344	7/16"	6 Pt.	Flex SAE Socket	3/8" Dr.
80345	1/2"	6 Pt.	Flex SAE Socket	3/8" Dr.
80346	9/16"	6 Pt.	Flex SAE Socket	3/8" Dr.
80347	5/8"	6 Pt.	Flex SAE Socket	3/8" Dr.
80348	11/16"	6 Pt.	Flex SAE Socket	3/8" Dr.
80349	3/4"	6 Pt.	Flex SAE Socket	3/8" Dr.



RATCHETS, SOCKETS & DRIVE TOOLS 3/8" DRIVE SETS



80565 - 10 Pc. METRIC 6 Pt. Flex Socket Set 3/8" DRIVE

Item No.	Description	
80333	10 mm 6 Pt. Flex Metric Socket	3/8" Dr.
80334	11 mm 6 Pt. Flex Metric Socket	3/8" Dr.
80335	12 mm 6 Pt. Flex Metric Socket	3/8" Dr.
80336	13 mm 6 Pt. Flex Metric Socket	3/8" Dr.
80337	14 mm 6 Pt. Flex Metric Socket	3/8" Dr.
80338	15 mm 6 Pt. Flex Metric Socket	3/8" Dr.
80339	16 mm 6 Pt. Flex Metric Socket	3/8" Dr.
80340	17 mm 6 Pt. Flex Metric Socket	3/8" Dr.
80341	18 mm 6 Pt. Flex Metric Socket	3/8" Dr.
80342	19 mm 6 Pt. Flex Metric Socket	3/8" Dr.



81229 - 3 Pc. Spark Plug Ratchet Set 3/8" DRIVE

Item No.	Description	
81213	Cushion Grip Offset Flex Teardrop Ratchet	3/8" Dr.
80546	6" Magnetic Swivel Spark Plug Socket 5/8"	3/8" Dr.
80547	6" Magnetic Swivel Spark Plug Socket 13/16"	3/8" Dr.

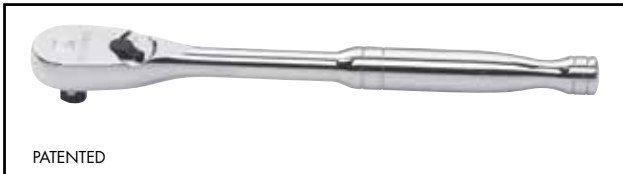

Full Polish Teardrop Ratchet 3/8" DRIVE

Item No.	Description	Overall Length (inch)	Weight (lbs)
81211	Full Polish Teardrop Ratchet	8.39"	0.680

- 60 tooth low profile ratchet



Full Polish Flex Teardrop Ratchet 3/8" DRIVE

Item No.	Description	Overall Length (inch)	Weight (lbs)
81215	Full Polish Flex Teardrop Ratchet	13.01"	0.850

- 60 tooth low profile ratchet



Full Polish Stubby Teardrop Ratchet 3/8" DRIVE

Item No.	Description	Overall Length (inch)	Weight (lbs)
81209	Full Polish Stubby Teardrop Ratchet	4.72"	0.410

- 60 tooth low profile ratchet

Full Polish Stubby Flex Teardrop Ratchet
3/8" DRIVE

Item No.	Description	Overall Length (inch)	Weight (lbs)
81212	Full Polish Stubby Flex Teardrop Ratchet	5.02"	0.520

- 60 tooth low profile ratchet

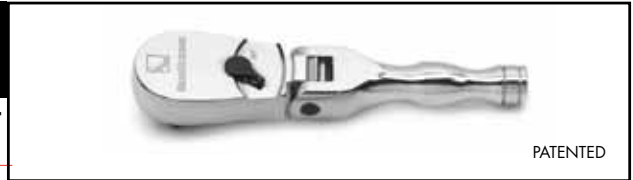

PATENTED

Full Polish Offset Flex Teardrop Ratchet
3/8" DRIVE

Item No.	Description	Overall Length (inch)	Weight (lbs)
81214	Full Polish Offset Flex Teardrop Ratchet	11"	0.900

- 60 tooth low profile ratchet



Quick-Release Flex Teardrop Ratchet 3/8" DRIVE

Item No.	Description	Overall Length (inch)	Weight (lbs)
81219	Quick-Release Flex Teardrop Ratchet	10.3"	0.600

- 45 tooth standard ratchet



Quick-Release Teardrop Ratchet 3/8" DRIVE

Item No.	Description	Overall Length (inch)	Weight (lbs)
81218	Quick-Release Teardrop Ratchet	7.87"	0.550

- 45 tooth standard ratchet

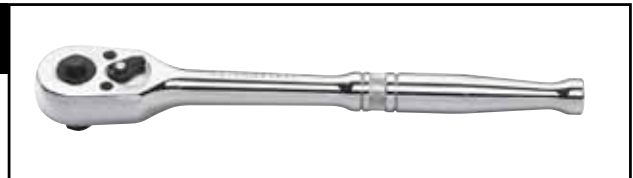

Cushion Grip Teardrop Ratchet 3/8" DRIVE

Item No.	Description	Overall Length (inch)	Weight (lbs)
81208	Cushion Grip Teardrop Ratchet	9.02"	0.640

- 60 tooth low profile ratchet



Cushion Grip Flex Teardrop Ratchet 3/8" DRIVE

Item No.	Description	Overall Length (inch)	Weight (lbs)
81210	Cushion Grip Flex Teardrop Ratchet	13.13"	0.940

- 60 tooth low profile ratchet



3/8" OPEN STOCK

RATCHETS, SOCKETS & DRIVE TOOLS



**Cushion Grip Offset Flex Teardrop Ratchet
3/8" DRIVE**

Item No.	Description	Overall Length (inch)	Weight (lbs)
81213	Cushion Grip Offset Flex Teardrop Ratchet	12.26"	0.990

- 60 tooth low profile ratchet



Cushion Grip Roto Ratchet 3/8" DRIVE

Item No.	Description	Overall Length (inch)	Weight (lbs)
81225	Cushion Grip Roto Ratchet	9.84"	0.760

- 72 tooth ratchet

Ratchet Repair Kit 3/8" DRIVE

Item No.	Description
81227	Ratchet Repair Kit

- for non-quick release and non-rotor ratchets

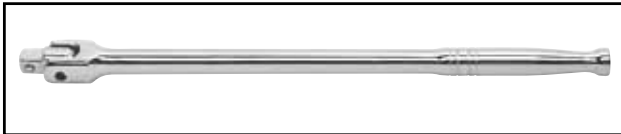

Full Polish Flex Handle 3/8" DRIVE

Item No.	Description	Overall Length (inch)	Weight (lbs)
81221	Full Polish Flex Handle	12.00"	0.400



Thumbwheel Ratchet 3/8" DRIVE

Item No.	Description	Weight (lbs)
81226	Thumbwheel Ratchet	0.110



Universal Joint 3/8" DRIVE

Item No.	Description	Weight (lbs)
80549	Universal Joint	0.132



Spring Universal Joint 3/8" DRIVE

Item No.	Description	Weight (lbs)
81233	Spring Universal Joint	0.160

PATENTED

RATCHETS, SOCKETS & DRIVE TOOLS 3/8" OPEN STOCK

Magnetic Universal Joint 3/8" DRIVE

Item No.	Description	Weight (lbs)
81256	Magnetic Universal Joint	0.413



Speeder Handle 3/8" DRIVE

Item No.	Description	Weight (lbs)
81239	Speeder Handle	1.100



81200 - 4 Pc. Extension Set 3/8" DRIVE

Item No.	Description	Weight (lbs)
81240	1-1/2" Extension	3/8" Dr.
81241	3" Extension	3/8" Dr.
81242	6" Extension	3/8" Dr.
81244	12" Extension	3/8" Dr.



Standard Extension 3/8" DRIVE

Item No.	Description	Weight (lbs)
81240	1-1/2" Standard Extension	0.088
81241	3" Standard Extension	0.154
81242	6" Standard Extension	0.330
81243	10" Standard Extension	0.528
81244	12" Standard Extension	0.616



Magnetic Extension 3/8" DRIVE

Item No.	Description	Weight (lbs)
81262	6" Magnetic Extension	0.458



81201 - 4 Pc. Wobble Extension Set 3/8" DRIVE

Item No.	Description	Weight (lbs)
81246	3" Extension	3/8" Dr.
81247	6" Extension	3/8" Dr.
81248	10" Extension	3/8" Dr.
81249	12" Extension	3/8" Dr.



3/8" OPEN STOCK
RATCHETS, SOCKETS & DRIVE TOOLS



Wobble Extension 3/8" DRIVE

Item No.	Description	Weight (lbs)
81245	1-1/2" Wobble Extension	0.088
81246	3" Wobble Extension	0.154
81247	6" Wobble Extension	0.330
81248	10" Wobble Extension	0.528
81249	12" Wobble Extension	0.616



81202 - Locking Extension Set 3/8" DRIVE

Item No.	Description	Weight (lbs)
81250	3" Locking Extension	0.154
81251	6" Locking Extension	0.330
81272	10" Locking Extension	0.528



Adapter 3/8" DRIVE

Item No.	Description	Weight (lbs)
81277	Adapter 3/8"F X 1/4"M	0.015
81278	Adapter 3/8"F X 1/2"M	0.046



Magnetic Adapter 3/8" DRIVE

Item No.	Description	Weight (lbs)
81259	Magnetic Adapter 3/8"F X 1/4"M	0.092
81260	Magnetic Adapter 3/8"F X 1/2"M	0.099



Spark Plug Socket SAE 3/8" DRIVE

Item No.	Description	Weight (lbs)
80402	5/8" Spark Plug	0.095
80403	13/16" Spark Plug	0.166



Swivel Magnetic Spark Plug Socket SAE 3/8" DRIVE

Item No.	Description	Overall Length (inch)	Weight (lbs)
80546	5/8" Swivel Magnetic Spark Plug	6"	0.431
80404	5/8" Swivel Magnetic Spark Plug	2.5"	0.198
80547	13/16" Swivel Magnetic Spark Plug	6"	0.530
80405	13/16" Swivel Magnetic Spark Plug	2.5"	0.359

6 Pt. & 12 Pt. Standard Socket SAE/METRIC 3/8" DRIVE

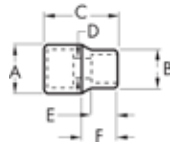

Item No.	Size	Description	Drive End (inch) A	Wrench End (inch) B	Overall Length (inch) C	Bolt Clearance D	Wrench Depth (Inch) E	Length to Shoulder F	Weight (lbs)
80350	1/4"	6 Pt. Std. SAE	0.677	0.394	0.984	0.197	0.295	0.453	0.044
80351	5/16"	6 Pt. Std. SAE	0.677	0.461	0.984	0.283	0.295	0.453	0.044
80352	3/8"	6 Pt. Std. SAE	0.677	0.543	0.984	0.283	0.295	0.453	0.046
80353	7/16"	6 Pt. Std. SAE	0.677	0.630	0.984	0.354	0.295	0.453	0.046
80354	1/2"	6 Pt. Std. SAE	0.705	0.685	0.984	0.354	0.295	0.453	0.055
80355	9/16"	6 Pt. Std. SAE	0.776	0.776	0.984	0.354	0.492	0.453	0.066
80356	5/8"	6 Pt. Std. SAE	0.874	0.874	0.984	0.354	0.492	0.453	0.088
80357	11/16"	6 Pt. Std. SAE	0.941	0.941	0.984	0.354	0.492	0.453	0.106
80358	3/4"	6 Pt. Std. SAE	1.020	1.020	0.984	0.354	0.492	0.453	0.121
80359	13/16"	6 Pt. Std. SAE	1.098	1.098	1.102	0.354	0.591	0.453	0.158
80360	7/8"	6 Pt. Std. SAE	1.169	1.169	1.102	0.354	0.591	0.453	0.158
80361	15/16"	6 Pt. Std. SAE	1.256	1.256	1.161	0.354	0.591	0.453	0.158
80362	1"	6 Pt. Std. SAE	1.335	1.335	1.319	0.354	0.709	0.453	0.160
80496	1/4"	12 Pt. Std. SAE	0.677	0.394	0.984	0.197	0.295	0.453	0.044
80497	5/16"	12 Pt. Std. SAE	0.677	0.461	0.984	0.283	0.295	0.453	0.044
80498	3/8"	12 Pt. Std. SAE	0.677	0.543	0.984	0.283	0.295	0.453	0.046
80499	7/16"	12 Pt. Std. SAE	0.677	0.630	0.984	0.354	0.295	0.453	0.046
80500	1/2"	12 Pt. Std. SAE	0.705	0.685	0.984	0.354	0.295	0.453	0.055
80501	9/16"	12 Pt. Std. SAE	0.776	0.776	0.984	0.354	0.492	0.453	0.066
80502	5/8"	12 Pt. Std. SAE	0.874	0.874	0.984	0.354	0.492	0.453	0.088
80503	11/16"	12 Pt. Std. SAE	0.941	0.941	0.984	0.354	0.492	0.453	0.106
80504	3/4"	12 Pt. Std. SAE	1.020	1.020	0.984	0.354	0.492	0.453	0.121
80505	13/16"	12 Pt. Std. SAE	1.098	1.098	1.102	0.354	0.591	0.453	0.158
80506	7/8"	12 Pt. Std. SAE	1.169	1.169	1.102	0.354	0.591	0.453	0.158
80507	15/16"	12 Pt. Std. SAE	1.256	1.256	1.161	0.354	0.591	0.453	0.158
80508	1"	12 Pt. Std. SAE	1.335	1.335	1.319	0.354	0.709	0.453	0.160
80374	6 mm	6 Pt. Std. Metric	0.669	0.366	0.984	0.197	0.295	0.453	0.040
80375	7 mm	6 Pt. Std. Metric	0.669	0.425	0.984	0.197	0.295	0.453	0.040
80376	8 mm	6 Pt. Std. Metric	0.669	0.472	0.984	0.283	0.295	0.453	0.044
80377	9 mm	6 Pt. Std. Metric	0.669	0.508	0.984	0.283	0.295	0.453	0.044

3/8" OPEN STOCK

RATCHETS, SOCKETS & DRIVE TOOLS



6 Pt. & 12 Pt. Standard Socket SAE/METRIC 3/8" DRIVE

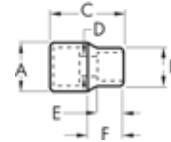

Item No.	Size	Description	Drive End (inch) A	Wrench End (inch) B	Overall Length (inch) C	Bolt Clearance D	Wrench Depth (Inch) E	Length to Shoulder F	Weight (lbs)
80378	10 mm	6 Pt. Std. Metric	0.669	0.571	0.984	0.283	0.295	0.453	0.044
80379	11 mm	6 Pt. Std. Metric	0.669	0.622	0.984	0.354	0.295	0.453	0.044
80380	12 mm	6 Pt. Std. Metric	0.669	0.654	0.984	0.354	0.315	0.453	0.046
80381	13 mm	6 Pt. Std. Metric	0.720	0.697	0.984	0.354	0.315	0.453	0.059
80382	14 mm	6 Pt. Std. Metric	0.768	0.768	0.984	0.354	0.492	0.453	0.059
80383	15 mm	6 Pt. Std. Metric	0.819	0.819	0.984	0.354	0.492	0.453	0.070
80384	16 mm	6 Pt. Std. Metric	0.866	0.866	0.984	0.354	0.492	0.453	0.084
80385	17 mm	6 Pt. Std. Metric	0.917	0.917	0.984	0.354	0.492	0.453	0.095
80386	18 mm	6 Pt. Std. Metric	0.937	0.937	0.984	0.354	0.492	0.453	0.095
80387	19 mm	6 Pt. Std. Metric	0.937	0.937	0.984	0.354	0.492	0.453	0.121
80330	20 mm	6 Pt. Std. Metric	1.016	1.063	1.102	0.354	0.591	0.453	0.130
80331	21 mm	6 Pt. Std. Metric	1.051	1.098	1.102	0.354	0.591	0.453	0.140
80332	22 mm	6 Pt. Std. Metric	1.114	1.161	1.102	0.354	0.591	0.453	0.150
80482	6 mm	12 Pt. Std. Metric	0.669	0.366	0.984	0.197	0.295	0.453	0.040
80483	7 mm	12 Pt. Std. Metric	0.669	0.425	0.984	0.197	0.295	0.453	0.040
80484	8 mm	12 Pt. Std. Metric	0.669	0.472	0.984	0.283	0.295	0.453	0.044
80485	9 mm	12 Pt. Std. Metric	0.669	0.508	0.984	0.283	0.295	0.453	0.044
80486	10 mm	12 Pt. Std. Metric	0.669	0.571	0.984	0.283	0.295	0.453	0.044
80487	11 mm	12 Pt. Std. Metric	0.669	0.622	0.984	0.354	0.295	0.453	0.044
80488	12 mm	12 Pt. Std. Metric	0.669	0.654	0.984	0.354	0.315	0.453	0.046
80489	13 mm	12 Pt. Std. Metric	0.720	0.697	0.984	0.354	0.315	0.453	0.059
80490	14 mm	12 Pt. Std. Metric	0.768	0.768	0.984	0.354	0.492	0.453	0.059
80491	15 mm	12 Pt. Std. Metric	0.819	0.819	0.984	0.354	0.492	0.453	0.070
80492	16 mm	12 Pt. Std. Metric	0.866	0.866	0.984	0.354	0.492	0.453	0.084
80493	17 mm	12 Pt. Std. Metric	0.917	0.917	0.984	0.354	0.492	0.453	0.095
80494	18 mm	12 Pt. Std. Metric	0.937	0.937	0.984	0.354	0.492	0.453	0.095
80495	19 mm	12 Pt. Std. Metric	0.957	1.004	0.984	0.354	0.492	0.453	0.121
80596	20 mm	12 Pt. Std. Metric	1.016	1.063	1.102	0.354	0.591	0.453	0.130
80597	21 mm	12 Pt. Std. Metric	1.051	1.098	1.102	0.354	0.591	0.453	0.140
80598	22 mm	12 Pt. Std. Metric	1.114	1.161	1.102	0.354	0.591	0.453	0.150

RATCHETS, SOCKETS & DRIVE TOOLS 3/8" OPEN STOCK

6 Pt. & 12 Pt. Deep Socket SAE/METRIC 3/8" DRIVE

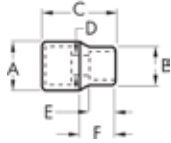

Item No.	Size	Description	Drive End (inch) A	Wrench End (inch) B	Overall Length (inch) C	Bolt Clearance (inch) D	Wrench Depth (Inch) E	Length to Shoulder (inch) F	Weight (lbs)
80363	1/4"	6 Pt. Deep SAE	0.661	0.394	2.500	0.217	0.157	1.142	0.054
80364	5/16"	6 Pt. Deep SAE	0.661	0.461	2.500	0.276	0.197	1.142	0.055
80365	3/8"	6 Pt. Deep SAE	0.661	0.543	2.500	0.335	0.201	1.142	0.059
80366	7/16"	6 Pt. Deep SAE	0.661	0.630	2.500	0.335	0.236	1.142	0.060
80367	1/2"	6 Pt. Deep SAE	0.720	0.685	2.500	0.335	0.287	1.142	0.065
80368	9/16"	6 Pt. Deep SAE	0.780	0.780	2.500	0.335	0.350	1.142	0.085
80369	5/8"	6 Pt. Deep SAE	0.866	0.866	2.500	0.335	0.398	1.142	0.107
80370	11/16"	6 Pt. Deep SAE	0.937	0.937	2.500	0.335	0.398	1.142	0.128
80371	3/4"	6 Pt. Deep SAE	1.016	1.016	2.500	0.335	0.457	1.142	0.148
80372	13/16"	6 Pt. Deep SAE	1.094	1.094	2.500	0.335	0.480	1.142	0.165
80373	7/8"	6 Pt. Deep SAE	1.173	1.173	2.500	0.335	0.520	1.142	0.197
80592	15/16"	6 Pt. Deep SAE	1.205	1.252	2.500	0.335	0.567	1.142	0.158
80593	1"	6 Pt. Deep SAE	1.272	1.319	2.500	0.335	0.567	1.142	0.160
80509	1/4"	12 Pt. Deep SAE	0.661	0.394	2.500	0.217	0.157	1.142	0.054
80510	5/16"	12 Pt. Deep SAE	0.661	0.461	2.500	0.276	0.197	1.142	0.055
80511	3/8"	12 Pt. Deep SAE	0.661	0.543	2.500	0.335	0.201	1.142	0.059
80512	7/16"	12 Pt. Deep SAE	0.661	0.630	2.500	0.335	0.236	1.142	0.060
80513	1/2"	12 Pt. Deep SAE	0.720	0.685	2.500	0.335	0.287	1.142	0.065
80514	9/16"	12 Pt. Deep SAE	0.780	0.780	2.500	0.335	0.350	1.142	0.085
80515	5/8"	12 Pt. Deep SAE	0.866	0.866	2.500	0.335	0.398	1.142	0.107
80516	11/16"	12 Pt. Deep SAE	0.937	0.937	2.500	0.335	0.398	1.142	0.128
80517	3/4"	12 Pt. Deep SAE	1.016	1.016	2.500	0.335	0.457	1.142	0.148
80518	13/16"	12 Pt. Deep SAE	1.094	1.094	2.500	0.335	0.480	1.142	0.165
80519	7/8"	12 Pt. Deep SAE	1.173	1.173	2.500	0.335	0.520	1.142	0.197
80594	15/16"	12 Pt. Deep SAE	1.205	1.252	2.500	0.335	0.567	1.142	0.170
80595	1"	12 Pt. Deep SAE	1.272	1.319	2.500	0.335	0.567	1.142	0.190

3/8" OPEN STOCK

RATCHETS, SOCKETS & DRIVE TOOLS



6 Pt. & 12 Pt. Deep Socket SAE/METRIC 3/8" DRIVE

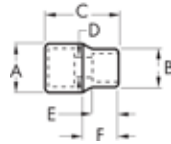

Item No.	Size	Description	Drive End (inch) A	Wrench End (inch) B	Overall Length (inch) C	Bolt Clearance D	Wrench Depth (Inch) E	Length to Shoulder F	Weight (lbs)
80388	6 mm	6 Pt. Deep Metric	0.661	0.508	2.500	0.315	0.197	1.142	0.052
80389	7 mm	6 Pt. Deep Metric	0.661	0.508	2.500	0.315	0.197	1.142	0.052
80390	8 mm	6 Pt. Deep Metric	0.661	0.508	2.500	0.315	0.197	1.142	0.052
80391	9 mm	6 Pt. Deep Metric	0.661	0.508	2.500	0.315	0.197	1.142	0.052
80392	10 mm	6 Pt. Deep Metric	0.661	0.571	2.500	0.335	0.201	1.142	0.058
80393	11 mm	6 Pt. Deep Metric	0.661	0.622	2.500	0.335	0.236	1.142	0.060
80394	12 mm	6 Pt. Deep Metric	0.661	0.654	2.500	0.335	0.260	1.142	0.067
80395	13 mm	6 Pt. Deep Metric	0.740	0.697	2.500	0.335	0.287	1.142	0.075
80396	14 mm	6 Pt. Deep Metric	0.768	0.768	2.500	0.335	0.350	1.142	0.082
80397	15 mm	6 Pt. Deep Metric	0.819	0.819	2.500	0.335	0.350	1.142	0.092
80398	16 mm	6 Pt. Deep Metric	0.866	0.866	2.500	0.335	0.398	1.142	0.102
80399	17 mm	6 Pt. Deep Metric	0.937	0.937	2.500	0.335	0.398	1.142	0.118
80400	18 mm	6 Pt. Deep Metric	0.937	0.937	2.500	0.335	0.421	1.142	0.125
80401	19 mm	6 Pt. Deep Metric	1.004	1.004	2.500	0.335	0.457	1.142	0.141
80406	20 mm	6 Pt. Deep Metric	1.016	1.063	2.500	0.335	0.480	1.142	0.150
80407	21 mm	6 Pt. Deep Metric	1.047	1.094	2.500	0.335	0.480	1.142	0.160
80408	22 mm	6 Pt. Deep Metric	1.114	1.161	2.500	0.335	0.520	1.142	0.170
80409	24 mm	6 Pt. Deep Metric	1.205	1.252	2.500	0.335	0.567	1.142	0.180
80520	6 mm	12 Pt. Deep Metric	0.661	0.394	2.500	0.217	0.157	1.142	0.054
80521	7 mm	12 Pt. Deep Metric	0.661	0.431	2.500	0.256	0.197	1.142	0.054
80522	8 mm	12 Pt. Deep Metric	0.661	0.472	2.500	0.276	0.197	1.142	0.055
80523	9 mm	12 Pt. Deep Metric	0.661	0.508	2.500	0.315	0.197	1.142	0.055
80524	10 mm	12 Pt. Deep Metric	0.661	0.571	2.500	0.335	0.201	1.142	0.058
80525	11 mm	12 Pt. Deep Metric	0.661	0.622	2.500	0.335	0.236	1.142	0.060
80526	12 mm	12 Pt. Deep Metric	0.661	0.654	2.500	0.335	0.260	1.142	0.067
80527	13 mm	12 Pt. Deep Metric	0.740	0.697	2.500	0.335	0.287	1.142	0.075
80528	14 mm	12 Pt. Deep Metric	0.768	0.768	2.500	0.335	0.350	1.142	0.082
80529	15 mm	12 Pt. Deep Metric	0.819	0.819	2.500	0.335	0.350	1.142	0.092
80530	16 mm	12 Pt. Deep Metric	0.866	0.866	2.500	0.335	0.398	1.142	0.102
80531	17 mm	12 Pt. Deep Metric	0.937	0.937	2.500	0.335	0.398	1.142	0.118
80532	18 mm	12 Pt. Deep Metric	0.937	0.937	2.500	0.335	0.421	1.142	0.125
80533	19 mm	12 Pt. Deep Metric	1.004	1.004	2.500	0.335	0.457	1.142	0.141

RATCHETS, SOCKETS & DRIVE TOOLS 3/8" OPEN STOCK

6 Pt. Flex Socket SAE/METRIC 3/8" DRIVE

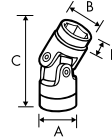

Item No.	Size	Description	Drive End (inch) A	Wrench End (inch) B	Overall Length (inch) C	Bolt Clearance D	Wrench Depth (Inch) E	Length to Shoulder F	Weight (lbs)
80343	3/8"	6 Pt. Flex SAE	0.748	0.571	1.732	N/A	0.220	N/A	0.123
80344	7/16"	6 Pt. Flex SAE	0.748	0.610	1.811	N/A	0.270	N/A	0.123
80345	1/2"	6 Pt. Flex SAE	0.748	0.748	1.850	N/A	0.350	N/A	0.130
80346	9/16"	6 Pt. Flex SAE	0.748	0.787	1.890	N/A	0.320	N/A	0.134
80347	5/8"	6 Pt. Flex SAE	0.748	0.866	1.890	N/A	0.400	N/A	0.136
80348	11/16"	6 Pt. Flex SAE	0.748	0.957	1.890	N/A	0.400	N/A	0.158
80349	3/4"	6 Pt. Flex SAE	0.748	1.016	2.008	N/A	0.450	N/A	0.163
80333	10 mm	6 Pt. Flex Metric	0.748	0.331	1.772	N/A	0.280	N/A	0.123
80334	11 mm	6 Pt. Flex Metric	0.748	0.337	1.772	N/A	0.300	N/A	0.123
80335	12 mm	6 Pt. Flex Metric	0.748	0.378	1.850	N/A	0.320	N/A	0.127
80336	13 mm	6 Pt. Flex Metric	0.748	0.425	1.890	N/A	0.290	N/A	0.134
80337	14 mm	6 Pt. Flex Metric	0.748	0.465	1.890	N/A	0.350	N/A	0.134
80338	15 mm	6 Pt. Flex Metric	0.748	0.500	1.890	N/A	0.370	N/A	0.134
80339	16 mm	6 Pt. Flex Metric	0.748	0.543	1.969	N/A	0.400	N/A	0.147
80340	17 mm	6 Pt. Flex Metric	0.748	0.598	1.969	N/A	0.400	N/A	0.158
80341	18 mm	6 Pt. Flex Metric	0.748	0.646	1.969	N/A	0.400	N/A	0.158
80342	19 mm	6 Pt. Flex Metric	0.748	0.677	1.969	N/A	0.450	N/A	0.164

3/8" OPEN STOCK

RATCHETS, SOCKETS & DRIVE TOOLS



80700 - 49 Pc. SAE/METRIC 6 Pt. Standard & Deep Socket Set 1/2" DRIVE

Item No.	Description			
80602	7/16"	6 Pt.	Std. SAE Socket	1/2" Dr.
80603	1/2"	6 Pt.	Std. SAE Socket	1/2" Dr.
80604	9/16"	6 Pt.	Std. SAE Socket	1/2" Dr.
80605	5/8"	6 Pt.	Std. SAE Socket	1/2" Dr.
80606	11/16"	6 Pt.	Std. SAE Socket	1/2" Dr.
80607	3/4"	6 Pt.	Std. SAE Socket	1/2" Dr.
80608	13/16"	6 Pt.	Std. SAE Socket	1/2" Dr.
80609	7/8"	6 Pt.	Std. SAE Socket	1/2" Dr.
80610	15/16"	6 Pt.	Std. SAE Socket	1/2" Dr.
80611	1"	6 Pt.	Std. SAE Socket	1/2" Dr.
80612	1-1/16"	6 Pt.	Std. SAE Socket	1/2" Dr.
80613	1-1/8"	6 Pt.	Std. SAE Socket	1/2" Dr.
80614	1/2"	6 Pt.	Deep SAE Socket	1/2" Dr.
80615	9/16"	6 Pt.	Deep SAE Socket	1/2" Dr.
80616	5/8"	6 Pt.	Deep SAE Socket	1/2" Dr.
80617	11/16"	6 Pt.	Std. SAE Socket	1/2" Dr.
80618	3/4"	6 Pt.	Std. SAE Socket	1/2" Dr.
80619	13/16"	6 Pt.	Deep SAE Socket	1/2" Dr.
80620	7/8"	6 Pt.	Deep SAE Socket	1/2" Dr.
80621	15/16"	6 Pt.	Std. SAE Socket	1/2" Dr.
80622	10 mm	6 Pt.	Std. Metric Socket	1/2" Dr.
80623	11 mm	6 Pt.	Std. Metric Socket	1/2" Dr.
80624	12 mm	6 Pt.	Std. Metric Socket	1/2" Dr.
80625	13 mm	6 Pt.	Std. Metric Socket	1/2" Dr.
80626	14 mm	6 Pt.	Std. Metric Socket	1/2" Dr.

Item No.	Description			
80627	15 mm	6 Pt.	Std. Metric Socket	1/2" Dr.
80628	16 mm	6 Pt.	Std. Metric Socket	1/2" Dr.
80629	17 mm	6 Pt.	Std. Metric Socket	1/2" Dr.
80630	18 mm	6 Pt.	Std. Metric Socket	1/2" Dr.
80631	19 mm	6 Pt.	Std. Metric Socket	1/2" Dr.
80632	20 mm	6 Pt.	Std. Metric Socket	1/2" Dr.
80633	21 mm	6 Pt.	Std. Metric Socket	1/2" Dr.
80634	22 mm	6 Pt.	Std. Metric Socket	1/2" Dr.
80635	23mm	6 Pt.	Std. Metric Socket	1/2" Dr.
80636	24 mm	6 Pt.	Std. Metric Socket	1/2" Dr.
80637	10 mm	6 Pt.	Deep Metric Socket	1/2" Dr.
80638	11 mm	6 Pt.	Deep Metric Socket	1/2" Dr.
80639	12 mm	6 Pt.	Deep Metric Socket	1/2" Dr.
80640	13 mm	6 Pt.	Deep Metric Socket	1/2" Dr.
80641	14 mm	6 Pt.	Deep Metric Socket	1/2" Dr.
80642	15 mm	6 Pt.	Std. Metric Socket	1/2" Dr.
80643	16 mm	6 Pt.	Std. Metric Socket	1/2" Dr.
80644	17 mm	6 Pt.	Deep Metric Socket	1/2" Dr.
80645	18 mm	6 Pt.	Std. Metric Socket	1/2" Dr.
80646	19 mm	6 Pt.	Std. Metric Socket	1/2" Dr.
80600	Universal Joint			1/2" Dr.
81340	3" Extension			1/2" Dr.
81341	5" Extension			1/2" Dr.
81304	Full Polish Teardrop Ratchet			1/2" Dr.
80700BM	Replacement Blow Mold Case			

80701 - 49 Pc. SAE/METRIC 12 Pt. Standard & Deep Socket Set 1/2" DRIVE

Item No.	Description			
80760	7/16"	12 Pt.	Std. SAE Socket	1/2" Dr.
80761	1/2"	12 Pt.	Std. SAE Socket	1/2" Dr.
80762	9/16"	12 Pt.	Std. SAE Socket	1/2" Dr.
80763	5/8"	12 Pt.	Std. SAE Socket	1/2" Dr.
80764	11/16"	12 Pt.	Std. SAE Socket	1/2" Dr.
80765	3/4"	12 Pt.	Std. SAE Socket	1/2" Dr.
80766	13/16"	12 Pt.	Std. SAE Socket	1/2" Dr.
80767	7/8"	12 Pt.	Std. SAE Socket	1/2" Dr.
80768	15/16"	12 Pt.	Std. SAE Socket	1/2" Dr.
80769	1"	12 Pt.	Std. SAE Socket	1/2" Dr.
80770	1-1/16"	12 Pt.	Std. SAE Socket	1/2" Dr.
80771	1-1/8"	12 Pt.	Std. SAE Socket	1/2" Dr.
80773	1/2"	12 Pt.	Deep SAE Socket	1/2" Dr.
80774	9/16"	12 Pt.	Deep SAE Socket	1/2" Dr.
80775	5/8"	12 Pt.	Deep SAE Socket	1/2" Dr.
80776	11/16"	12 Pt.	Deep SAE Socket	1/2" Dr.
80777	3/4"	12 Pt.	Std. SAE Socket	1/2" Dr.
80778	13/16"	12 Pt.	Std. SAE Socket	1/2" Dr.
80779	7/8"	12 Pt.	Deep SAE Socket	1/2" Dr.
80780	15/16"	12 Pt.	Deep SAE Socket	1/2" Dr.
80745	10 mm	12 Pt.	Std. Metric Socket	1/2" Dr.
80746	11 mm	12 Pt.	Std. Metric Socket	1/2" Dr.
80747	12 mm	12 Pt.	Std. Metric Socket	1/2" Dr.
80748	13 mm	12 Pt.	Std. Metric Socket	1/2" Dr.
80749	14 mm	12 Pt.	Std. Metric Socket	1/2" Dr.
80750	15 mm	12 Pt.	Std. Metric Socket	1/2" Dr.
80751	16 mm	12 Pt.	Std. Metric Socket	1/2" Dr.
80752	17 mm	12 Pt.	Std. Metric Socket	1/2" Dr.
80753	18 mm	12 Pt.	Std. Metric Socket	1/2" Dr.
80754	19 mm	12 Pt.	Std. Metric Socket	1/2" Dr.
80755	20 mm	12 Pt.	Std. Metric Socket	1/2" Dr.
80756	21 mm	12 Pt.	Std. Metric Socket	1/2" Dr.
80757	22 mm	12 Pt.	Std. Metric Socket	1/2" Dr.
80758	23mm	12 Pt.	Std. Metric Socket	1/2" Dr.
80759	24 mm	12 Pt.	Std. Metric Socket	1/2" Dr.
80781	10 mm	12 Pt.	Deep Metric Socket	1/2" Dr.
80782	11 mm	12 Pt.	Deep Metric Socket	1/2" Dr.
80783	12 mm	12 Pt.	Deep Metric Socket	1/2" Dr.



Item No.	Description			
80784	13 mm	12 Pt.	Deep Metric Socket	1/2" Dr.
80785	14 mm	12 Pt.	Deep Metric Socket	1/2" Dr.
80786	15 mm	12 Pt.	Deep Metric Socket	1/2" Dr.
80787	16 mm	12 Pt.	Std. Metric Socket	1/2" Dr.
80788	17 mm	12 Pt.	Std. Metric Socket	1/2" Dr.
80789	18 mm	12 Pt.	Deep Metric Socket	1/2" Dr.
80790	19 mm	12 Pt.	Deep Metric Socket	1/2" Dr.
81340	3" Extension			1/2" Dr.
81341	5" Extension			1/2" Dr.
80600	Universal Joint			1/2" Dr.
81304	Full Polish Teardrop Ratchet			1/2" Dr.
80700BM	Replacement Blow Mold Case			

1/2" DRIVE SETS
RATCHETS, SOCKETS & DRIVE TOOLS



80715 - 33 Pc. SAE 6Pt. Standard & Deep Socket Set 1/2" DRIVE

Item No.	Description			
80602	7/16"	6 Pt.	Std. SAE Socket	1/2" Dr.
80603	1/2"	6 Pt.	Std. SAE Socket	1/2" Dr.
80604	9/16"	6 Pt.	Std. SAE Socket	1/2" Dr.
80605	5/8"	6 Pt.	Std. SAE Socket	1/2" Dr.
80606	11/16"	6 Pt.	Std. SAE Socket	1/2" Dr.
80607	3/4"	6 Pt.	Std. SAE Socket	1/2" Dr.
80608	13/16"	6 Pt.	Std. SAE Socket	1/2" Dr.
80609	7/8"	6 Pt.	Std. SAE Socket	1/2" Dr.
80610	15/16"	6 Pt.	Std. SAE Socket	1/2" Dr.
80611	1"	6 Pt.	Std. SAE Socket	1/2" Dr.
80612	1-1/16"	6 Pt.	Std. SAE Socket	1/2" Dr.
80613	1-1/8"	6 Pt.	Std. SAE Socket	1/2" Dr.

Item No.	Description			
80678	1-1/4"	6 Pt.	Std. SAE Socket	1/2" Dr.
80679	1-1/2"	6 Pt.	Std. SAE Socket	1/2" Dr.
80684	7/16"	6 Pt.	Deep SAE Socket	1/2" Dr.
80614	1/2"	6 Pt.	Deep SAE Socket	1/2" Dr.
80615	9/16"	6 Pt.	Deep SAE Socket	1/2" Dr.
80616	5/8"	6 Pt.	Deep SAE Socket	1/2" Dr.
80617	11/16"	6 Pt.	Deep SAE Socket	1/2" Dr.
80618	3/4"	6 Pt.	Deep SAE Socket	1/2" Dr.
80619	13/16"	6 Pt.	Deep SAE Socket	1/2" Dr.
80620	7/8"	6 Pt.	Deep SAE Socket	1/2" Dr.
80621	15/16"	6 Pt.	Deep SAE Socket	1/2" Dr.
80674	1"	6 Pt.	Deep SAE Socket	1/2" Dr.
80675	1-1/16"	6 Pt.	Deep SAE Socket	1/2" Dr.
80676	1-1/8"	6 Pt.	Deep SAE Socket	1/2" Dr.
80685	1-1/4"	6 Pt.	Deep SAE Socket	1/2" Dr.
80686	1-1/2"	6 Pt.	Deep SAE Socket	1/2" Dr.
81304	Full Polish Teardrop Ratchet			1/2" Dr.
81340	3" Extension			1/2" Dr.
81341	5" Extension			1/2" Dr.
81307	Full Polish Flex Handle			1/2" Dr.
80600	Universal Joint			1/2" Dr.

80714 - 33 Pc. SAE 12 Pt. Standard & Deep Socket Set 1/2" DRIVE

Item No.	Description			
80760	7/16"	12 Pt.	Std. SAE Socket	1/2" Dr.
80761	1/2"	12 Pt.	Std. SAE Socket	1/2" Dr.
80762	9/16"	12 Pt.	Std. SAE Socket	1/2" Dr.
80763	5/8"	12 Pt.	Std. SAE Socket	1/2" Dr.
80764	11/16"	12 Pt.	Std. SAE Socket	1/2" Dr.
80765	3/4"	12 Pt.	Std. SAE Socket	1/2" Dr.
80766	13/16"	12 Pt.	Std. SAE Socket	1/2" Dr.
80767	7/8"	12 Pt.	Std. SAE Socket	1/2" Dr.
80768	15/16"	12 Pt.	Std. SAE Socket	1/2" Dr.
80769	1"	12 Pt.	Std. SAE Socket	1/2" Dr.
80770	1-1/16"	12 Pt.	Std. SAE Socket	1/2" Dr.
80771	1-1/8"	12 Pt.	Std. SAE Socket	1/2" Dr.
80794	1-1/4"	12 Pt.	Std. SAE Socket	1/2" Dr.
80680	1-1/2"	12 Pt.	Std. SAE Socket	1/2" Dr.
80772	7/16"	12 Pt.	Deep SAE Socket	1/2" Dr.
80773	1/2"	12 Pt.	Deep SAE Socket	1/2" Dr.
80774	9/16"	12 Pt.	Deep SAE Socket	1/2" Dr.
80775	5/8"	12 Pt.	Deep SAE Socket	1/2" Dr.
80776	11/16"	12 Pt.	Deep SAE Socket	1/2" Dr.
80777	3/4"	12 Pt.	Deep SAE Socket	1/2" Dr.
80778	13/16"	12 Pt.	Deep SAE Socket	1/2" Dr.
80779	7/8"	12 Pt.	Deep SAE Socket	1/2" Dr.



Item No.	Description			
80780	15/16"	12 Pt.	Deep SAE Socket	1/2" Dr.
80795	1"	12 Pt.	Deep SAE Socket	1/2" Dr.
80796	1-1/16"	12 Pt.	Deep SAE Socket	1/2" Dr.
80797	1-1/8"	12 Pt.	Deep SAE Socket	1/2" Dr.
80798	1-1/4"	12 Pt.	Deep SAE Socket	1/2" Dr.
80799	1-1/2"	6 Pt.	Deep SAE Socket	1/2" Dr.
81304	Full Polish Teardrop Ratchet			1/2" Dr.
81340	3" Extension			1/2" Dr.
81341	5" Extension			1/2" Dr.
81307	Full Polish Flex Handle			1/2" Dr.
80600	Universal Joint			1/2" Dr.

1/2" DRIVE SETS
RATCHETS, SOCKETS & DRIVE TOOLS



**80707 - 23 Pc. SAE Standard & Deep Socket Set
1/2" DRIVE**

Item No. Description

80615	1/2"	6 Pt.	Deep SAE Socket	1/2" Dr.
80614	9/16"	6 Pt.	Deep SAE Socket	1/2" Dr.
80616	5/8"	6 Pt.	Deep SAE Socket	1/2" Dr.
80617	11/16"	6 Pt.	Deep SAE Socket	1/2" Dr.
80618	3/4"	6 Pt.	Deep SAE Socket	1/2" Dr.
80619	13/16"	6 Pt.	Deep SAE Socket	1/2" Dr.
80620	7/8"	6 Pt.	Deep SAE Socket	1/2" Dr.

Item No. Description

80621	15/16"	6 Pt.	Deep SAE Socket	1/2" Dr.
80602	7/16"	6 Pt.	Std. SAE Socket	1/2" Dr.
80603	1/2"	6 Pt.	Std. SAE Socket	1/2" Dr.
80604	9/16"	6 Pt.	Std. SAE Socket	1/2" Dr.
80605	5/8"	6 Pt.	Std. SAE Socket	1/2" Dr.
80606	11/16"	6 Pt.	Std. SAE Socket	1/2" Dr.
80607	3/4"	6 Pt.	Std. SAE Socket	1/2" Dr.
80608	13/16"	6 Pt.	Std. SAE Socket	1/2" Dr.
80609	7/8"	6 Pt.	Std. SAE Socket	1/2" Dr.
80610	15/16"	6 Pt.	Std. SAE Socket	1/2" Dr.
80611	1"	6 Pt.	Std. SAE Socket	1/2" Dr.
80612	1-1/16"	6 Pt.	Std. SAE Socket	1/2" Dr.
80613	1-1/8"	6 Pt.	Std. SAE Socket	1/2" Dr.
81341	5" Extension			1/2" Dr.
81343	15" Extension			1/2" Dr.
81304	Full Polish Teardrop Ratchet			1/2" Dr.



**80709 - 28 Pc. METRIC Standard & Deep Socket Set
1/2" DRIVE**

Item No. Description

80637	10 mm	6 Pt.	Deep Metric Socket	1/2" Dr.
80638	11 mm	6 Pt.	Deep Metric Socket	1/2" Dr.
80639	12 mm	6 Pt.	Deep Metric Socket	1/2" Dr.
80640	13 mm	6 Pt.	Deep Metric Socket	1/2" Dr.
80641	14 mm	6 Pt.	Deep Metric Socket	1/2" Dr.
80642	15 mm	6 Pt.	Deep Metric Socket	1/2" Dr.
80643	16 mm	6 Pt.	Deep Metric Socket	1/2" Dr.
80644	17 mm	6 Pt.	Deep Metric Socket	1/2" Dr.
80645	18 mm	6 Pt.	Deep Metric Socket	1/2" Dr.
80646	19 mm	6 Pt.	Deep Metric Socket	1/2" Dr.

Item No. Description

80745	10 mm	12 Pt.	Std. Metric Socket	1/2" Dr.
80746	11 mm	12 Pt.	Std. Metric Socket	1/2" Dr.
80747	12 mm	12 Pt.	Std. Metric Socket	1/2" Dr.
80748	13 mm	12 Pt.	Std. Metric Socket	1/2" Dr.
80749	14 mm	12 Pt.	Std. Metric Socket	1/2" Dr.
80750	15 mm	12 Pt.	Std. Metric Socket	1/2" Dr.
80751	16 mm	12 Pt.	Std. Metric Socket	1/2" Dr.
80752	17 mm	12 Pt.	Std. Metric Socket	1/2" Dr.
80753	18 mm	12 Pt.	Std. Metric Socket	1/2" Dr.
80754	19 mm	12 Pt.	Std. Metric Socket	1/2" Dr.
80755	20 mm	12 Pt.	Std. Metric Socket	1/2" Dr.
80756	21 mm	12 Pt.	Std. Metric Socket	1/2" Dr.
80757	22 mm	12 Pt.	Std. Metric Socket	1/2" Dr.
80758	23 mm	12 Pt.	Std. Metric Socket	1/2" Dr.
80759	24 mm	12 Pt.	Std. Metric Socket	1/2" Dr.
81341	5" Extension			1/2" Dr.
81343	15" Extension			1/2" Dr.
81304	Full Polish Teardrop Ratchet			1/2" Dr.

**80717 - 17 Pc. SAE 6 Pt. Standard Socket Set
1/2" DRIVE**

Item No.	Description	
80602	7/16"	6 Pt. Std. SAE Socket 1/2" Dr.
80603	1/2"	6 Pt. Std. SAE Socket 1/2" Dr.
80604	9/16"	6 Pt. Std. SAE Socket 1/2" Dr.
80605	5/8"	6 Pt. Std. SAE Socket 1/2" Dr.
80606	11/16"	6 Pt. Std. SAE Socket 1/2" Dr.
80607	3/4"	6 Pt. Std. SAE Socket 1/2" Dr.
80608	13/16"	6 Pt. Std. SAE Socket 1/2" Dr.
80609	7/8"	6 Pt. Std. SAE Socket 1/2" Dr.
80610	15/16"	6 Pt. Std. SAE Socket 1/2" Dr.
80611	1"	6 Pt. Std. SAE Socket 1/2" Dr.
80612	1-1/16"	6 Pt. Std. SAE Socket 1/2" Dr.
80613	1-1/8"	6 Pt. Std. SAE Socket 1/2" Dr.
80678	1-1/4"	6 Pt. Std. SAE Socket 1/2" Dr.



Item No.	Description	
80679	1-1/2"	6 Pt. Std. SAE Socket 1/2" Dr.
81304	Full Polish Teardrop Ratchet 1/2" Dr.	
81341	5" Extension 1/2" Dr.	
81307	Full Polish Flex Handle 1/2" Dr.	
80600	Std. Universal Joint 1/2" Dr.	

**80716 - 17 Pc. SAE 12 Pt. Standard Socket Set
1/2" DRIVE**

Item No.	Description	
80760	7/16"	12 Pt. Std. SAE Socket 1/2" Dr.
80761	1/2"	12 Pt. Std. SAE Socket 1/2" Dr.
80762	9/16"	12 Pt. Std. SAE Socket 1/2" Dr.
80763	5/8"	12 Pt. Std. SAE Socket 1/2" Dr.
80764	11/16"	12 Pt. Std. SAE Socket 1/2" Dr.
80765	3/4"	12 Pt. Std. SAE Socket 1/2" Dr.
80766	13/16"	12 Pt. Std. SAE Socket 1/2" Dr.
80767	7/8"	12 Pt. Std. SAE Socket 1/2" Dr.
80768	15/16"	12 Pt. Std. SAE Socket 1/2" Dr.
80769	1"	12 Pt. Std. SAE Socket 1/2" Dr.
80770	1-1/16"	12 Pt. Std. SAE Socket 1/2" Dr.
80771	1-1/8"	12 Pt. Std. SAE Socket 1/2" Dr.
80794	1-1/4"	12 Pt. Std. SAE Socket 1/2" Dr.



Item No.	Description	
80680	1-1/2"	12 Pt. Std. SAE Socket 1/2" Dr.
81304	Full Polish Teardrop Ratchet 1/2" Dr.	
81341	5" Extension 1/2" Dr.	
81307	Full Polish Flex Handle 1/2" Dr.	
80600	Universal Joint 1/2" Dr.	

1/2" DRIVE SETS

RATCHETS, SOCKETS & DRIVE TOOLS



**80706 - 15 Pc. SAE 6 Pt. Standard Socket Set
1/2" DRIVE**

Item No.	Description			
80602	7/16"	6 Pt.	Std. SAE Socket	1/2" Dr.
80603	1/2"	6 Pt.	Std. SAE Socket	1/2" Dr.
80604	9/16"	6 Pt.	Std. SAE Socket	1/2" Dr.
80605	5/8"	6 Pt.	Std. SAE Socket	1/2" Dr.
80606	11/16"	6 Pt.	Std. SAE Socket	1/2" Dr.
80607	3/4"	6 Pt.	Std. SAE Socket	1/2" Dr.
80608	13/16"	6 Pt.	Std. SAE Socket	1/2" Dr.
80609	7/8"	6 Pt.	Std. SAE Socket	1/2" Dr.
80610	15/16"	6 Pt.	Std. SAE Socket	1/2" Dr.
80611	1"	6 Pt.	Std. SAE Socket	1/2" Dr.
80612	1-1/16"	6 Pt.	Std. SAE Socket	1/2" Dr.
80613	1-1/8"	6 Pt.	Std. SAE Socket	1/2" Dr.
81341	5" Extension			1/2" Dr.
81343	15" Extension			1/2" Dr.
81304	Full Polish Teardrop Ratchet			1/2" Dr.



**80708 - 18 Pc. METRIC 6 Pt. Standard Socket Set
1/2" DRIVE**

Item No.	Description			
80622	10 mm	6 Pt.	Std. Metric Socket	1/2" Dr.
80623	11 mm	6 Pt.	Std. Metric Socket	1/2" Dr.
80624	12 mm	6 Pt.	Std. Metric Socket	1/2" Dr.
80625	13 mm	6 Pt.	Std. Metric Socket	1/2" Dr.
80626	14 mm	6 Pt.	Std. Metric Socket	1/2" Dr.
80627	15 mm	6 Pt.	Std. Metric Socket	1/2" Dr.
80628	16 mm	6 Pt.	Std. Metric Socket	1/2" Dr.
80629	17 mm	6 Pt.	Std. Metric Socket	1/2" Dr.
80630	18 mm	6 Pt.	Std. Metric Socket	1/2" Dr.
80631	19 mm	6 Pt.	Std. Metric Socket	1/2" Dr.
80632	20 mm	6 Pt.	Std. Metric Socket	1/2" Dr.
80633	21 mm	6 Pt.	Std. Metric Socket	1/2" Dr.
80634	22 mm	6 Pt.	Std. Metric Socket	1/2" Dr.
80635	23mm	6 Pt.	Std. Metric Socket	1/2" Dr.
80636	24 mm	6 Pt.	Std. Metric Socket	1/2" Dr.
81341	5" Extension			1/2" Dr.
81343	15" Extension			1/2" Dr.
81304	Full Polish Teardrop Ratchet			1/2" Dr.

**80729 - 27 Pc. SAE 6 Pt. Standard Socket
Accessory Kit 1/2" DRIVE**

Item No.	Description			
80602	7/16"	6 Pt.	Std. SAE Socket	1/2" Dr.
80603	1/2"	6 Pt.	Std. SAE Socket	1/2" Dr.
80604	9/16"	6 Pt.	Std. SAE Socket	1/2" Dr.
80605	5/8"	6 Pt.	Std. SAE Socket	1/2" Dr.
80606	11/16"	6 Pt.	Std. SAE Socket	1/2" Dr.
80607	3/4"	6 Pt.	Std. SAE Socket	1/2" Dr.
80608	13/16"	6 Pt.	Std. SAE Socket	1/2" Dr.
80609	7/8"	6 Pt.	Std. SAE Socket	1/2" Dr.
80610	15/16"	6 Pt.	Std. SAE Socket	1/2" Dr.
80611	1"	6 Pt.	Std. SAE Socket	1/2" Dr.
80612	1-1/16"	6 Pt.	Std. SAE Socket	1/2" Dr.
80613	1-1/8"	6 Pt.	Std. SAE Socket	1/2" Dr.
80678	1-1/4"	6 Pt.	Std. SAE Socket	1/2" Dr.
80679	1-1/2"	6 Pt.	Std. SAE Socket	1/2" Dr.
80614	1/2"	6 Pt.	Deep SAE Socket	1/2" Dr.
80615	9/16"	6 Pt.	Deep SAE Socket	1/2" Dr.
80616	5/8"	6 Pt.	Deep SAE Socket	1/2" Dr.



Item No.	Description			
80617	11/16"	6 Pt.	Deep SAE Socket	1/2" Dr.
80618	3/4"	6 Pt.	Deep SAE Socket	1/2" Dr.
80619	13/16"	6 Pt.	Deep SAE Socket	1/2" Dr.
80620	7/8"	6 Pt.	Deep SAE Socket	1/2" Dr.
80621	15/16"	6 Pt.	Deep SAE Socket	1/2" Dr.
80674	1"	6 Pt.	Deep SAE Socket	1/2" Dr.
80675	1-1/16"	6 Pt.	Deep SAE Socket	1/2" Dr.
80676	1-1/8"	6 Pt.	Deep SAE Socket	1/2" Dr.
80685	1-1/4"	6 Pt.	Deep SAE Socket	1/2" Dr.
80686	1-1/2"	6 Pt.	Deep SAE Socket	1/2" Dr.

1/2" DRIVE SETS

RATCHETS, SOCKETS & DRIVE TOOLS



80730 - 37 Pc. METRIC 12 Pt. Standard & Deep Socket Set 1/2" DRIVE

Item No.	Description			
80806	9 mm	12 Pt.	Std. Metric Socket	1/2" Dr.
80745	10 mm	12 Pt.	Std. Metric Socket	1/2" Dr.
80746	11 mm	12 Pt.	Std. Metric Socket	1/2" Dr.
80747	12 mm	12 Pt.	Std. Metric Socket	1/2" Dr.
80748	13 mm	12 Pt.	Std. Metric Socket	1/2" Dr.
80749	14 mm	12 Pt.	Std. Metric Socket	1/2" Dr.
80750	15 mm	12 Pt.	Std. Metric Socket	1/2" Dr.
80751	16 mm	12 Pt.	Std. Metric Socket	1/2" Dr.
80752	17 mm	12 Pt.	Std. Metric Socket	1/2" Dr.
80753	18 mm	12 Pt.	Std. Metric Socket	1/2" Dr.
80754	19 mm	12 Pt.	Std. Metric Socket	1/2" Dr.
80755	20 mm	12 Pt.	Std. Metric Socket	1/2" Dr.
80756	21 mm	12 Pt.	Std. Metric Socket	1/2" Dr.
80757	22 mm	12 Pt.	Std. Metric Socket	1/2" Dr.
80758	23 mm	12 Pt.	Std. Metric Socket	1/2" Dr.

Item No.	Description			
80759	24 mm	12 Pt.	Std. Metric Socket	1/2" Dr.
80811	25 mm	12 Pt.	Std. Metric Socket	1/2" Dr.
80681	26 mm	12 Pt.	Std. Metric Socket	1/2" Dr.
80812	27 mm	12 Pt.	Std. Metric Socket	1/2" Dr.
80682	29 mm	12 Pt.	Std. Metric Socket	1/2" Dr.
80683	28 mm	12 Pt.	Std. Metric Socket	1/2" Dr.
80813	30 mm	12 Pt.	Std. Metric Socket	1/2" Dr.
80814	32 mm	12 Pt.	Std. Metric Socket	1/2" Dr.
80815	36 mm	12 Pt.	Std. Metric Socket	1/2" Dr.
80785	14 mm	12 Pt.	Deep Metric Socket	1/2" Dr.
80786	15 mm	12 Pt.	Deep Metric Socket	1/2" Dr.
80787	16 mm	12 Pt.	Deep Metric Socket	1/2" Dr.
80788	17 mm	12 Pt.	Deep Metric Socket	1/2" Dr.
80789	18 mm	12 Pt.	Deep Metric Socket	1/2" Dr.
80790	19 mm	12 Pt.	Deep Metric Socket	1/2" Dr.
80817	20 mm	12 Pt.	Deep Metric Socket	1/2" Dr.
80818	21 mm	12 Pt.	Deep Metric Socket	1/2" Dr.
80820	22 mm	12 Pt.	Deep Metric Socket	1/2" Dr.
80822	24 mm	12 Pt.	Deep Metric Socket	1/2" Dr.
80824	27 mm	12 Pt.	Deep Metric Socket	1/2" Dr.
80826	30 mm	12 Pt.	Deep Metric Socket	1/2" Dr.
80827	32 mm	12 Pt.	Deep Metric Socket	1/2" Dr.

**80731 - 15 Pc. SAE 12 Pt. Standard Socket Set
1/2" DRIVE**

Item No.	Description			
80760	7/16"	12 Pt.	Std. SAE Socket	1/2" Dr.
80761	1/2"	12 Pt.	Std. SAE Socket	1/2" Dr.
80762	9/16"	12 Pt.	Std. SAE Socket	1/2" Dr.
80763	5/8"	12 Pt.	Std. SAE Socket	1/2" Dr.
80764	11/16"	12 Pt.	Std. SAE Socket	1/2" Dr.
80765	3/4"	12 Pt.	Std. SAE Socket	1/2" Dr.
80766	13/16"	12 Pt.	Std. SAE Socket	1/2" Dr.
80767	7/8"	12 Pt.	Std. SAE Socket	1/2" Dr.
80768	15/16"	12 Pt.	Std. SAE Socket	1/2" Dr.
80769	1"	12 Pt.	Std. SAE Socket	1/2" Dr.
80770	1-1/16"	12 Pt.	Std. SAE Socket	1/2" Dr.



80771	1-1/8"	12 Pt.	Std. SAE Socket	1/2" Dr.
80793	1-3/16"	12 Pt.	Std. SAE Socket	1/2" Dr.
80794	1-1/4"	12 Pt.	Std. SAE Socket	1/2" Dr.
80680	1-1/2"	12 Pt.	Std. SAE Socket	1/2" Dr.

**80703 - 11 Pc. SAE 6 Pt. Standard Socket Set
1/2" DRIVE**

Item No.	Description			
80603	1/2"	6 Pt.	Std. SAE Socket	1/2" Dr.
80604	9/16"	6 Pt.	Std. SAE Socket	1/2" Dr.
80605	5/8"	6 Pt.	Std. SAE Socket	1/2" Dr.
80606	11/16"	6 Pt.	Std. SAE Socket	1/2" Dr.
80607	3/4"	6 Pt.	Std. SAE Socket	1/2" Dr.
80608	13/16"	6 Pt.	Std. SAE Socket	1/2" Dr.
80609	7/8"	6 Pt.	Std. SAE Socket	1/2" Dr.



80610	15/16"	6 Pt.	Std. SAE Socket	1/2" Dr.
80611	1"	6 Pt.	Std. SAE Socket	1/2" Dr.
80612	1-1/16"	6 Pt.	Std. SAE Socket	1/2" Dr.
80613	1-1/8"	6 Pt.	Std. SAE Socket	1/2" Dr.

**80711 - 11 Pc. SAE 12 Pt. Standard Socket Set
1/2" DRIVE**

Item No.	Description			
80761	1/2"	12 Pt.	Std. SAE Socket	1/2" Dr.
80762	9/16"	12 Pt.	Std. SAE Socket	1/2" Dr.
80763	5/8"	12 Pt.	Std. SAE Socket	1/2" Dr.
80764	11/16"	12 Pt.	Std. SAE Socket	1/2" Dr.
80765	3/4"	12 Pt.	Std. SAE Socket	1/2" Dr.
80766	13/16"	12 Pt.	Std. SAE Socket	1/2" Dr.



80767	7/8"	12 Pt.	Std. SAE Socket	1/2" Dr.
80768	15/16"	12 Pt.	Std. SAE Socket	1/2" Dr.
80769	1"	12 Pt.	Std. SAE Socket	1/2" Dr.
80770	1-1/16"	12 Pt.	Std. SAE Socket	1/2" Dr.
80771	1-1/8"	12 Pt.	Std. SAE Socket	1/2" Dr.



**80733 - 14 Pc. SAE 6 Pt. Deep Socket Set
1/2" DRIVE**

Item No.	Description
80684	7/16" 6 & 12 Pt. Deep SAE Socket 1/2" Dr.
80614	1/2" 6 Pt. Deep SAE Socket 1/2" Dr.
80615	9/16" 6 Pt. Deep SAE Socket 1/2" Dr.
80616	5/8" 6 Pt. Deep SAE Socket 1/2" Dr.

Item No.	Description
80617	11/16" 6 Pt. Deep SAE Socket 1/2" Dr.
80618	3/4" 6 Pt. Deep SAE Socket 1/2" Dr.
80619	13/16" 6 Pt. Deep SAE Socket 1/2" Dr.
80620	7/8" 6 Pt. Deep SAE Socket 1/2" Dr.
80621	15/16" 6 Pt. Deep SAE Socket 1/2" Dr.
80674	1" 6 Pt. Deep SAE Socket 1/2" Dr.
80675	1-1/16" 6 Pt. Deep SAE Socket 1/2" Dr.
80676	1-1/8" 6 Pt. Deep SAE Socket 1/2" Dr.
80685	1-1/4" 6 Pt. Deep SAE Socket 1/2" Dr.
80686	1-1/2" 6 Pt. Deep SAE Socket 1/2" Dr.
80686	1-1/2" 6 Pt. Deep SAE Socket 1/2" Dr.



**80732 - 14 Pc. SAE 12 Pt. Deep Socket Set
1/2" DRIVE**

Item No.	Description
80772	7/16" 12 Pt. Deep SAE Socket 1/2" Dr.
80773	1/2" 12 Pt. Deep SAE Socket 1/2" Dr.
80774	9/16" 12 Pt. Deep SAE Socket 1/2" Dr.

Item No.	Description
80775	5/8" 12 Pt. Deep SAE Socket 1/2" Dr.
80776	11/16" 12 Pt. Deep SAE Socket 1/2" Dr.
80777	3/4" 12 Pt. Deep SAE Socket 1/2" Dr.
80778	13/16" 12 Pt. Deep SAE Socket 1/2" Dr.
80779	7/8" 12 Pt. Deep SAE Socket 1/2" Dr.
80780	15/16" 12 Pt. Deep SAE Socket 1/2" Dr.
80795	1" 12 Pt. Deep SAE Socket 1/2" Dr.
80796	1-1/16" 12 Pt. Deep SAE Socket 1/2" Dr.
80797	1-1/8" 12 Pt. Deep SAE Socket 1/2" Dr.
80798	1-1/4" 12 Pt. Deep SAE Socket 1/2" Dr.
80687	1-1/2" 12 Pt. Deep SAE Socket 1/2" Dr.

**80705 - 8 Pc. SAE 6 Pt. Deep Socket Set
1/2" DRIVE**

Item No.	Description			
80614	1/2"	6 Pt.	Deep SAE Socket	1/2" Dr.
80615	9/16"	6 Pt.	Deep SAE Socket	1/2" Dr.
80616	5/8"	6 Pt.	Deep SAE Socket	1/2" Dr.
80617	11/16"	6 Pt.	Deep SAE Socket	1/2" Dr.
80618	3/4"	6 Pt.	Deep SAE Socket	1/2" Dr.
80619	13/16"	6 Pt.	Deep SAE Socket	1/2" Dr.



80620	7/8"	6 Pt.	Deep SAE Socket	1/2" Dr.
80621	15/16"	6 Pt.	Deep SAE Socket	1/2" Dr.

**80713 - 8 Pc. SAE 12 Pt. Deep Socket Set
1/2" DRIVE**

Item No.	Description			
80773	1/2"	12 Pt.	Deep SAE Socket	1/2" Dr.
80774	9/16"	12 Pt.	Deep SAE Socket	1/2" Dr.
80775	5/8"	12 Pt.	Deep SAE Socket	1/2" Dr.
80776	11/16"	12 Pt.	Deep SAE Socket	1/2" Dr.
80777	3/4"	12 Pt.	Deep SAE Socket	1/2" Dr.
80778	13/16"	12 Pt.	Deep SAE Socket	1/2" Dr.



80779	7/8"	12 Pt.	Deep SAE Socket	1/2" Dr.
80780	15/16"	12 Pt.	Deep SAE Socket	1/2" Dr.

**80702 - 13 Pc. METRIC 6 Pt. Standard Socket Set
1/2" DRIVE**

Item No.	Description			
80624	12 mm	6 Pt.	Std. Metric Socket	1/2" Dr.
80625	13 mm	6 Pt.	Std. Metric Socket	1/2" Dr.
80626	14 mm	6 Pt.	Std. Metric Socket	1/2" Dr.
80627	15 mm	6 Pt.	Std. Metric Socket	1/2" Dr.
80628	16 mm	6 Pt.	Std. Metric Socket	1/2" Dr.
80629	17 mm	6 Pt.	Std. Metric Socket	1/2" Dr.
80630	18 mm	6 Pt.	Std. Metric Socket	1/2" Dr.
80631	19 mm	6 Pt.	Std. Metric Socket	1/2" Dr.



80632	20 mm	6 Pt.	Std. Metric Socket	1/2" Dr.
80633	21 mm	6 Pt.	Std. Metric Socket	1/2" Dr.
80634	22 mm	6 Pt.	Std. Metric Socket	1/2" Dr.
80635	23mm	6 Pt.	Std. Metric Socket	1/2" Dr.
80636	24 mm	6 Pt.	Std. Metric Socket	1/2" Dr.



80710 - 13 Pc. METRIC 12 Pt. Standard Socket Set 1/2" DRIVE

Item No. Description

80747	12 mm	12 Pt.	Std. Metric Socket	1/2" Dr.
80748	13 mm	12 Pt.	Std. Metric Socket	1/2" Dr.
80749	14 mm	12 Pt.	Std. Metric Socket	1/2" Dr.
80750	15 mm	12 Pt.	Std. Metric Socket	1/2" Dr.
80751	16 mm	12 Pt.	Std. Metric Socket	1/2" Dr.

Item No. Description

80752	17 mm	12 Pt.	Std. Metric Socket	1/2" Dr.
80753	18 mm	12 Pt.	Std. Metric Socket	1/2" Dr.
80754	19 mm	12 Pt.	Std. Metric Socket	1/2" Dr.
80755	20 mm	12 Pt.	Std. Metric Socket	1/2" Dr.
80756	21 mm	12 Pt.	Std. Metric Socket	1/2" Dr.
80757	22 mm	12 Pt.	Std. Metric Socket	1/2" Dr.
80758	23mm	12 Pt.	Std. Metric Socket	1/2" Dr.
80759	24 mm	12 Pt.	Std. Metric Socket	1/2" Dr.



80704 - 10 Pc. METRIC 6 Pt. Deep Socket Set 1/2" DRIVE

Item No. Description

80637	10 mm	6 Pt.	Deep Metric Socket	1/2" Dr.
80638	11 mm	6 Pt.	Deep Metric Socket	1/2" Dr.
80639	12 mm	6 Pt.	Deep Metric Socket	1/2" Dr.

Item No. Description

80640	13 mm	6 Pt.	Deep Metric Socket	1/2" Dr.
80641	14 mm	6 Pt.	Deep Metric Socket	1/2" Dr.
80642	15 mm	6 Pt.	Deep Metric Socket	1/2" Dr.
80643	16 mm	6 Pt.	Deep Metric Socket	1/2" Dr.
80644	17 mm	6 Pt.	Deep Metric Socket	1/2" Dr.
80645	18 mm	6 Pt.	Deep Metric Socket	1/2" Dr.
80646	19 mm	6 Pt.	Deep Metric Socket	1/2" Dr.



80712 - 10 Pc. METRIC 12 Pt. Deep Socket Set 1/2" DRIVE

Item No. Description

80781	10 mm	12 Pt.	Deep Metric Socket	1/2" Dr.
80782	11 mm	12 Pt.	Deep Metric Socket	1/2" Dr.
80783	12 mm	12 Pt.	Deep Metric Socket	1/2" Dr.

Item No. Description

80784	13 mm	12 Pt.	Deep Metric Socket	1/2" Dr.
80785	14 mm	12 Pt.	Deep Metric Socket	1/2" Dr.
80786	15 mm	12 Pt.	Deep Metric Socket	1/2" Dr.
80787	16 mm	12 Pt.	Deep Metric Socket	1/2" Dr.
80788	17 mm	12 Pt.	Deep Metric Socket	1/2" Dr.
80789	18 mm	12 Pt.	Deep Metric Socket	1/2" Dr.
80790	19 mm	12 Pt.	Deep Metric Socket	1/2" Dr.



Patented

Full Polish Teardrop Ratchet 1/2" DRIVE

Item No.	Description	Overall Length (inch)	Weight (lbs)
81304	Full Polish Teardrop Ratchet	11"	1.630

- 60 tooth low profile ratchet

Full Polish Flex Teardrop Ratchet 1/2" DRIVE

Item No.	Description	Overall Length (inch)	Weight (lbs)
81306	Full Polish Flex Teardrop Ratchet	16.98"	1.630

- 60 tooth low profile ratchet



Patented

Cushion Grip Teardrop Ratchet 1/2" DRIVE

Item No.	Description	Overall Length (inch)	Weight (lbs)
81303	Cushion Grip Teardrop Ratchet	11.61"	1.360

- 60 tooth low profile ratchet



Patented

Quick Release Tear Drop Ratchet 1/2" DRIVE

Item No.	Description	Weight (lbs)
81309	Quick Release Tear Drop Ratchet	1.630

- 45 tooth standard ratchet



Sliding T handle 1/2" DRIVE

Item No.	Description	Weight (lbs)
81311	Sliding T handle	1.320



Speeder Handle 1/2" DRIVE

Item No.	Description	Weight (lbs)
81312	Speeder Handle	1.800

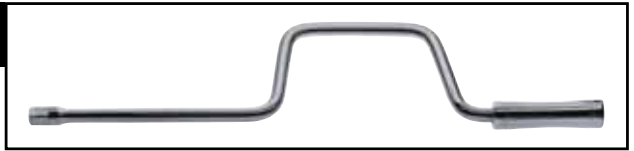

Full Polish Flex Handle SAE 1/2" DRIVE

Item No.	Description	Overall Length (inch)	Weight (lbs)
81307	Full Polish Flex Handle	15"	0.800
81308	Full Polish Flex Handle	24"	1.000

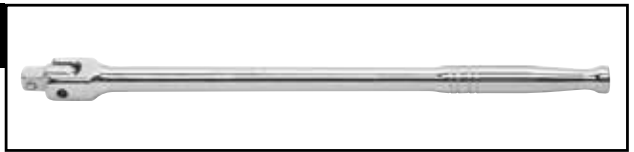

Ratchet Repair Kit 1/2" DRIVE

Item No.	Description
81339	Ratchet Repair Kit

- for non-quick release and non-rotor ratchets

1/2" OPEN STOCK

RATCHETS, SOCKETS & DRIVE TOOLS



Universal Joint SAE 1/2" DRIVE

Item No.	Description	Weight (lbs)
80600	Universal Joint	0.319



Spring Universal Joint SAE 1/2" DRIVE

Item No.	Description	Weight (lbs)
81234	Spring Universal Joint	0.330

Patented



Magnetic Universal Joint SAE 1/2" DRIVE

Item No.	Description	Weight (lbs)
81257	Magnetic Universal Joint	0.733



Standard Adapter SAE 1/2" DRIVE

Item No.	Description	Weight (lbs)
81354	Standard Adapter 1/2" F x 3/8" M	0.110
81355	Standard Adapter 1/2" F x 3/4" M	0.440



81300 - 3 Pc. Standard Extension Set 1/2" DRIVE

Item No.	Description	
81341	5" Extension	1/2" Dr.
81342	10" Extension	1/2" Dr.
81343	15" Extension	1/2" Dr.

Standard Extension SAE 1/2" DRIVE

Item No.	Description	Weight (lbs)
81340	3" Standard Extension	0.280
81341	5" Standard Extension	0.440
81342	10" Standard Extension	0.860
81343	15" Standard Extension	1.360



Magnetic Extension SAE 1/2" DRIVE

Item No.	Description	Weight (lbs)
81263	6" Magnetic Extension	0.688



81301 - 3 Pc. Wobble Extension Set 1/2" DRIVE

Item No.	Description	Weight (lbs)
81345	5" Wobble Extension	1/2" Dr.
81346	10" Wobble Extension	1/2" Dr.
81347	15" Wobble Extension	1/2" Dr.



Wobble Extension SAE 1/2" DRIVE

Item No.	Description	Weight (lbs)
81344	3" Wobble Extension	0.280
81345	5" Wobble Extension	0.440
81346	10" Wobble Extension	0.860
81347	15" Wobble Extension	1.360



81302 - 3 Pc. Locking Extension Set 1/2" DRIVE

Item No.	Description	Weight (lbs)
81348	3" Locking Extension	1/2" Dr.
81349	10" Locking Extension	1/2" Dr.
81350	15" Locking Extension	1/2" Dr.



1/2" OPEN STOCK
RATCHETS, SOCKETS & DRIVE TOOLS

RATCHETS, SOCKETS & DRIVE TOOLS



6 Pt. & 12 Pt. Standard Socket SAE/METRIC 1/2" DRIVE

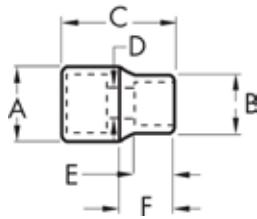

Item No.	Size	Description	Drive End	Wrench	Overall	Bolt	Wrench	Length to	Weight (lbs)
			(inch) A	End (inch) B	Length (inch) C	Clearance D	Depth (Inch) E	Shoulder F	
80602	7/16"	6 Pt. Std. SAE	0.874	0.669	1.488	0.283	0.551	0.748	0.121
80605	1/2"	6 Pt. Std. SAE	0.874	0.732	1.488	0.354	0.551	0.748	0.121
80603	1/2"	6 Pt. Std. SAE	0.874	0.732	1.488	0.354	0.551	0.748	0.121
80604	9/16"	6 Pt. Std. SAE	0.874	0.732	1.488	0.354	0.551	0.748	0.121
80606	11/16"	6 Pt. Std. SAE	0.937	0.937	1.488	0.472	0.591	0.748	0.165
80607	3/4"	6 Pt. Std. SAE	1.020	1.020	1.488	0.472	0.768	0.748	0.165
80608	13/16"	6 Pt. Std. SAE	1.098	1.098	1.488	0.472	0.768	0.748	0.191
80609	7/8"	6 Pt. Std. SAE	1.177	1.177	1.488	0.472	0.768	0.748	0.224
80610	15/16"	6 Pt. Std. SAE	1.256	1.256	1.488	0.472	0.807	0.748	0.253
80611	1"	6 Pt. Std. SAE	1.335	1.335	1.575	0.472	0.886	0.748	0.319
80612	1-1/16"	6 Pt. Std. SAE	1.413	1.413	1.575	0.472	0.886	0.748	0.341
80613	1-1/8"	6 Pt. Std. SAE	1.492	1.492	1.654	0.472	0.965	0.748	0.350
80677	1-3/16"	6 Pt. Std. SAE	1.524	1.571	1.654	0.453	0.965	1.496	0.500
80678	1-1/4"	6 Pt. Std. SAE	1.602	1.650	1.654	0.453	0.965	1.496	0.500
80679	1-1/2"	6 Pt. Std. SAE	1.913	1.961	1.969	0.453	1.220	1.496	0.550
80760	7/16"	12 Pt. Std. SAE	0.874	0.669	1.488	0.283	0.551	0.748	0.121
80761	1/2"	12 Pt. Std. SAE	0.874	0.732	1.488	0.354	0.551	0.748	0.121
80763	1/2"	12 Pt. Std. SAE	0.874	0.732	1.488	0.354	0.551	0.748	0.121
80762	9/16"	12 Pt. Std. SAE	0.874	0.732	1.488	0.354	0.551	0.748	0.121
80764	11/16"	12 Pt. Std. SAE	0.937	0.937	1.488	0.472	0.591	0.748	0.165
80765	3/4"	12 Pt. Std. SAE	1.020	1.020	1.488	0.472	0.768	0.748	0.165
80766	13/16"	12 Pt. Std. SAE	1.098	1.098	1.488	0.472	0.768	0.748	0.191
80767	7/8"	12 Pt. Std. SAE	1.177	1.177	1.488	0.472	0.768	0.748	0.224
80768	15/16"	12 Pt. Std. SAE	1.256	1.256	1.488	0.472	0.807	0.748	0.253
80769	1"	12 Pt. Std. SAE	1.335	1.335	1.575	0.472	0.886	0.748	0.319
80770	1-1/16"	12 Pt. Std. SAE	1.413	1.413	1.575	0.472	0.886	0.748	0.341
80771	1-1/8"	12 Pt. Std. SAE	1.492	1.492	1.654	0.472	0.965	1.496	0.350
80793	1-3/16"	12 Pt. Std. SAE	1.524	1.571	1.654	0.472	0.965	1.496	0.500
80794	1-1/4"	12 Pt. Std. SAE	1.602	1.650	1.654	0.472	0.965	1.496	0.500
80680	1-1/2"	12 Pt. Std. SAE	1.913	1.961	1.969	0.472	1.220	1.496	0.550

Item No.	Size	Description	Drive End (inch) A	Wrench End (inch) B	Overall Length (inch) C	Bolt Clearance D	Wrench Depth (Inch) E	Length to Shoulder F	Weight (lbs)
80622	10mm	6 Pt. Std. Metric	0.866	0.602	1.488	0.283	0.551	0.748	0.110
80623	11mm	6 Pt. Std. Metric	0.866	0.650	1.488	0.354	0.551	0.748	0.114
80624	12mm	6 Pt. Std. Metric	0.866	0.701	1.488	0.354	0.551	0.748	0.114
80625	13mm	6 Pt. Std. Metric	0.866	0.748	1.488	0.421	0.551	0.748	0.121
80626	14mm	6 Pt. Std. Metric	0.866	0.799	1.488	0.421	0.571	0.748	0.125
80627	15mm	6 Pt. Std. Metric	0.866	0.843	1.488	0.421	0.571	0.748	0.125
80628	16mm	6 Pt. Std. Metric	0.866	0.850	1.488	0.472	0.571	0.748	0.132
80629	17mm	6 Pt. Std. Metric	0.941	0.941	1.488	0.472	0.591	0.748	0.158
80630	18mm	6 Pt. Std. Metric	0.980	0.980	1.488	0.472	0.591	0.748	0.172
80631	19mm	6 Pt. Std. Metric	1.020	1.020	1.488	0.472	0.768	0.748	0.176
80632	20mm	6 Pt. Std. Metric	1.094	1.094	1.488	0.472	0.768	0.748	0.198
80633	21mm	6 Pt. Std. Metric	1.098	1.098	1.488	0.472	0.768	0.748	0.187
80634	22mm	6 Pt. Std. Metric	1.177	1.177	1.488	0.472	0.768	0.748	0.220
80635	23mm	6 Pt. Std. Metric	1.256	1.256	1.488	0.472	0.807	0.748	0.264
80636	24mm	6 Pt. Std. Metric	1.256	1.256	1.488	0.472	0.807	0.748	0.275
80805	8mm	12 Pt. Std. Metric	0.866	0.524	1.488	0.283	0.551	0.748	0.330
80806	9mm	12 Pt. Std. Metric	0.866	0.563	1.488	0.283	0.551	0.748	0.130
80745	10mm	12 Pt. Std. Metric	0.866	0.602	1.488	0.283	0.551	0.748	0.110
80746	11mm	12 Pt. Std. Metric	0.866	0.650	1.488	0.354	0.551	0.748	0.114
80747	12mm	12 Pt. Std. Metric	0.866	0.701	1.488	0.354	0.551	0.748	0.114
80748	13mm	12 Pt. Std. Metric	0.866	0.748	1.488	0.421	0.551	0.748	0.121
80749	14mm	12 Pt. Std. Metric	0.866	0.799	1.488	0.421	0.571	0.748	0.125
80750	15mm	12 Pt. Std. Metric	0.866	0.843	1.488	0.421	0.571	0.748	0.125
80751	16mm	12 Pt. Std. Metric	0.866	0.850	1.488	0.472	0.571	0.748	0.132
80752	17mm	12 Pt. Std. Metric	0.941	0.941	1.488	0.472	0.591	0.748	0.158
80753	18mm	12 Pt. Std. Metric	0.980	0.980	1.488	0.472	0.591	0.748	0.172
80754	19mm	12 Pt. Std. Metric	1.020	1.020	1.488	0.472	0.768	0.748	0.176
80755	20mm	12 Pt. Std. Metric	1.094	1.094	1.488	0.472	0.768	0.748	0.198
80756	21mm	12 Pt. Std. Metric	1.098	1.098	1.488	0.472	0.768	0.748	0.187
80757	22mm	12 Pt. Std. Metric	1.177	1.177	1.488	0.472	0.768	0.748	0.220
80758	23mm	12 Pt. Std. Metric	1.256	1.256	1.488	0.472	0.807	0.748	0.264
80759	24mm	12 Pt. Std. Metric	1.256	1.256	1.488	0.472	0.807	0.748	0.275
80811	25mm	12 Pt. Std. Metric	1.262	1.309	1.488	0.000	0.807	0.748	0.130
80681	26 mm	12 Pt. Std. Metric	1.287	1.335	1.575	0.453	0.886	1.496	0.280
80812	27mm	12 Pt. Std. Metric	1.366	1.413	1.575	0.000	0.886	0.748	0.275
80682	28 mm	12 Pt. Std. Metric	1.433	1.480	1.575	0.453	0.886	1.496	0.300
80683	29 mm	12 Pt. Std. Metric	1.445	1.492	1.575	0.453	0.886	1.496	0.330
80813	30mm	12 Pt. Std. Metric	1.524	1.571	1.654	0.000	0.965	0.748	0.275
80814	32mm	12 Pt. Std. Metric	1.602	1.650	1.654	0.000	0.965	0.748	0.275
80815	36mm	12 Pt. Std. Metric	1.921	1.969	1.969	0.000	1.102	0.748	0.300

1/2" OPEN STOCK

RATCHETS, SOCKETS & DRIVE TOOLS



6 Pt. & 12 Pt. Deep Socket SAE/METRIC 1/2" DRIVE

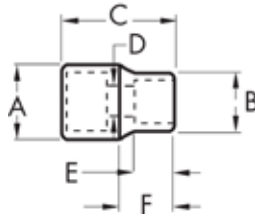

RATCHETS, SOCKETS & DRIVE TOOLS 1/2" OPEN STOCK

Item No.	Size	Description	Drive End	Wrench	Overall	Bolt	Wrench	Length to	Weight
			(inch) A	End (inch) B	Length (inch) C	Clearance D	Depth (Inch) E	Shoulder F	(lbs)
80684	7/16"	6 Pt. Deep SAE	0.866	0.669	3.031	0.394	0.000	1.496	0.231
80614	1/2"	6 Pt. Deep SAE	0.866	0.732	3.031	0.453	0.287	1.496	0.242
80615	9/16"	6 Pt. Deep SAE	0.866	0.811	3.031	0.453	0.350	1.496	0.253
80616	5/8"	6 Pt. Deep SAE	0.866	0.850	3.031	0.453	0.398	1.496	0.286
80617	11/16"	6 Pt. Deep SAE	0.937	0.937	3.031	0.453	0.398	1.496	0.341
80618	3/4"	6 Pt. Deep SAE	1.016	1.016	3.031	0.453	0.457	1.496	0.374
80619	13/16"	6 Pt. Deep SAE	1.094	1.094	3.031	0.453	0.480	1.496	0.418
80620	7/8"	6 Pt. Deep SAE	1.173	1.173	3.031	0.453	0.520	1.496	0.495
80621	15/16"	6 Pt. Deep SAE	1.252	1.252	3.031	0.453	0.567	1.496	0.550
80674	1"	6 Pt. Deep SAE	1.283	1.331	3.031	0.453	0.457	1.496	0.400
80675	1-1/16"	6 Pt. Deep SAE	1.362	1.409	3.031	0.453	0.457	1.496	0.400
80676	1-1/8"	6 Pt. Deep SAE	1.441	1.488	3.031	0.453	0.457	1.496	0.450
80685	1-1/4"	6 Pt. Deep SAE	1.598	1.646	3.031	0.453	0.000	0.000	0.500
80686	1-1/2"	6 Pt. Deep SAE	1.913	1.961	1.969	0.000	1.220	0.000	0.500
80772	7/16"	12 Pt. Deep SAE	0.870	0.670	3.030	0.390	0.240	1.500	0.231
80773	1/2"	12 Pt. Deep SAE	0.866	0.732	3.031	0.453	0.287	1.496	0.242
80774	9/16"	12 Pt. Deep SAE	0.866	0.811	3.031	0.453	0.350	1.496	0.253
80775	5/8"	12 Pt. Deep SAE	0.866	0.850	3.031	0.453	0.398	1.496	0.286
80776	11/16"	12 Pt. Deep SAE	0.937	0.937	3.031	0.453	0.398	1.496	0.341
80777	3/4"	12 Pt. Deep SAE	1.016	1.016	3.031	0.453	0.457	1.496	0.374
80778	13/16"	12 Pt. Deep SAE	1.094	1.094	3.031	0.453	0.480	1.496	0.418
80779	7/8"	12 Pt. Deep SAE	1.173	1.173	3.031	0.453	0.520	1.496	0.495
80780	15/16"	12 Pt. Deep SAE	1.252	1.252	3.031	0.453	0.567	1.496	0.550
80795	1"	12 Pt. Deep SAE	1.283	1.331	3.031	0.453	0.642	1.496	0.550
80796	1-1/16"	12 Pt. Deep SAE	1.362	1.409	3.031	0.453	0.677	1.496	0.550
80797	1-1/8"	12 Pt. Deep SAE	1.441	1.488	3.031	0.453	0.772	1.496	0.280
80798	1-1/4"	12 Pt. Deep SAE	1.598	1.646	3.031	0.453	0.870	1.496	0.300
80687	1-1/2"	12 Pt. Deep SAE	1.598	1.646	3.031	0.453	0.870	1.496	0.300

Item No.	Size	Description	Drive End	Wrench	Overall	Bolt	Wrench	Length to	Weight
			(inch)	End (inch)	Length (inch)	Clearance	Depth (Inch)	Shoulder	(lbs)
			A	B	C	D	E	F	
80637	10mm	6 Pt. Deep Metric	0.866	0.602	3.031	0.374	0.201	1.496	0.231
80638	11mm	6 Pt. Deep Metric	0.866	0.650	3.031	0.394	0.236	1.496	0.231
80639	12mm	6 Pt. Deep Metric	0.866	0.701	3.031	0.433	0.260	1.496	0.238
80640	13mm	6 Pt. Deep Metric	0.866	0.748	3.031	0.453	0.287	1.496	0.246
80641	14mm	6 Pt. Deep Metric	0.866	0.799	3.031	0.453	0.350	1.496	0.246
80642	15mm	6 Pt. Deep Metric	0.866	0.843	3.031	0.453	0.350	1.496	0.246
80643	16mm	6 Pt. Deep Metric	0.866	0.850	3.031	0.453	0.398	1.496	0.286
80644	17mm	6 Pt. Deep Metric	0.937	0.937	3.031	0.453	0.398	1.496	0.304
80645	18mm	6 Pt. Deep Metric	0.976	0.976	3.031	0.453	0.421	1.496	0.330
80646	19mm	6 Pt. Deep Metric	1.016	1.016	3.031	0.453	0.457	1.496	0.341
80781	10mm	12 Pt. Deep Metric	0.866	0.602	3.031	0.374	0.201	1.496	0.231
80782	11mm	12 Pt. Deep Metric	0.866	0.650	3.031	0.394	0.236	1.496	0.231
80783	12mm	12 Pt. Deep Metric	0.866	0.701	3.031	0.433	0.260	1.496	0.238
80784	13mm	12 Pt. Deep Metric	0.866	0.748	3.031	0.453	0.287	1.496	0.246
80785	14mm	12 Pt. Deep Metric	0.866	0.799	3.031	0.453	0.350	1.496	0.246
80786	15mm	12 Pt. Deep Metric	0.866	0.843	3.031	0.453	0.350	1.496	0.246
80787	16mm	12 Pt. Deep Metric	0.866	0.850	3.031	0.453	0.398	1.496	0.286
80788	17mm	12 Pt. Deep Metric	0.937	0.937	3.031	0.453	0.398	1.496	0.304
80789	18mm	12 Pt. Deep Metric	0.976	0.976	3.031	0.453	0.421	1.496	0.330
80790	19mm	12 Pt. Deep Metric	1.016	1.016	3.031	0.453	0.457	1.496	0.341
80817	20mm	12 Pt. Deep Metric	1.047	1.094	3.031	0.453	0.480	0.748	0.400
80818	21mm	12 Pt. Deep Metric	1.047	1.094	3.031	0.453	0.480	0.748	0.430
80820	22mm	12 Pt. Deep Metric	1.126	1.173	3.031	0.453	0.520	0.748	0.450
80822	24mm	12 Pt. Deep Metric	1.205	1.252	3.031	0.453	0.567	0.748	0.460
80824	27mm	12 Pt. Deep Metric	1.362	1.409	3.031	0.453	0.642	0.748	0.480
80826	30mm	12 Pt. Deep Metric	1.520	1.567	3.031	0.453	0.677	0.748	0.500
80827	32mm	12 Pt. Deep Metric	1.598	1.646	3.031	0.453	0.772	0.748	0.550

1/2" OPEN STOCK

RATCHETS, SOCKETS & DRIVE TOOLS



**80879 - 13 Pc. SAE Standard Socket Set
3/4" DRIVE**

Item No.	Description			
80830	7/8"	12 Pt.	Std. SAE Socket	3/4" Dr.
80831	15/16"	12 Pt.	Std. SAE Socket	3/4" Dr.
80833	1"	12 Pt.	Std. SAE Socket	3/4" Dr.
80834	1-1/16"	12 Pt.	Std. SAE Socket	3/4" Dr.
80835	1-1/8"	12 Pt.	Std. SAE Socket	3/4" Dr.
80838	1-3/16"	12 Pt.	Std. SAE Socket	3/4" Dr.
80839	1-1/4"	12 Pt.	Std. SAE Socket	3/4" Dr.
80840	1-5/16"	12 Pt.	Std. SAE Socket	3/4" Dr.
80841	1-7/16"	12 Pt.	Std. SAE Socket	3/4" Dr.
80852	1-1/2"	12 Pt.	Std. SAE Socket	3/4" Dr.
80854	1-1/2"	12 Pt.	Std. SAE Socket	3/4" Dr.
81412	8" Extension			3/4" Dr.
81400	Quick-Release Teardrop Ratchet			3/4" Dr.



**80880 - 27 Pc. SAE Standard Socket Set
3/4" DRIVE**

Item No.	Description			
80852	1-7/16"	12 Pt.	Std. SAE Socket	3/4" Dr.
80854	1-1/2"	12 Pt.	Std. SAE Socket	3/4" Dr.
80855	1-5/8"	12 Pt.	Std. SAE Socket	3/4" Dr.
80856	1-11/16"	12 Pt.	Std. SAE Socket	3/4" Dr.
80857	1-3/4"	12 Pt.	Std. SAE Socket	3/4" Dr.
80859	1-13/16"	12 Pt.	Std. SAE Socket	3/4" Dr.
80860	1-7/8"	12 Pt.	Std. SAE Socket	3/4" Dr.
80861	2"	12 Pt.	Std. SAE Socket	3/4" Dr.
80862	2-1/8"	12 Pt.	Std. SAE Socket	3/4" Dr.
80863	2-3/16"	12 Pt.	Std. SAE Socket	3/4" Dr.
80864	2-1/4"	12 Pt.	Std. SAE Socket	3/4" Dr.
80865	2-3/8"	12 Pt.	Std. SAE Socket	3/4" Dr.
81411	5" Extension			3/4" Dr.
81412	8" Extension			3/4" Dr.
81413	16" Extension			3/4" Dr.
81400	Quick-Release Teardrop Ratchet			3/4" Dr.
81401	18"	Sliding T Handle		3/4" Dr.
81404	19"	Flex Handle		3/4" Dr.

Item No.	Description			
80830	7/8"	12 Pt.	Std. SAE Socket	3/4" Dr.
80831	15/16"	12 Pt.	Std. SAE Socket	3/4" Dr.
80833	1"	12 Pt.	Std. SAE Socket	3/4" Dr.
80834	1-1/16"	12 Pt.	Std. SAE Socket	3/4" Dr.
80835	1-1/8"	12 Pt.	Std. SAE Socket	3/4" Dr.
80838	1-3/16"	12 Pt.	Std. SAE Socket	3/4" Dr.
80839	1-1/4"	12 Pt.	Std. SAE Socket	3/4" Dr.
80840	1-5/16"	12 Pt.	Std. SAE Socket	3/4" Dr.
80841	1-3/8"	12 Pt.	Std. SAE Socket	3/4" Dr.

Quick Release Ratchet 3/4" DRIVE

Item No.	Description	Overall Length (inch)	Weight (lbs)
81400	Quick-Release Ratchet	19.75"	5.280

- 24 tooth standard ratchet



Sliding T Handle 3/4" DRIVE

Item No.	Description	Overall Length (inch)	Weight (lbs)
81401	Sliding T	19.00"	3.036



Flex Handle 3/4" DRIVE

Item No.	Description	Overall Length (inch)	Weight (lbs)
81404	Flex Handle	19.00"	4.070



Standard Extension 3/4" DRIVE

Item No.	Description	Weight (lbs)
81411	5" Standard Extension	1.100
81412	8" Standard Extension	2.000
81413	16" Standard Extension	3.058



81499 - Ratchet Repair Kit 3/4" DRIVE

3/4" OPEN STOCK

RATCHETS, SOCKETS & DRIVE TOOLS



12 Pt. Standard Socket SAE 3/4" DRIVE

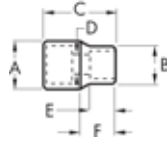

Item No.	Size	Description	Drive End	Wrench	Overall	Bolt	Wrench	Length to	Weight (lbs)
			(inch)	End (inch)	Length (inch)	Clearance	Depth (Inch)	Shoulder	
			A	B	C	D	E	F	
80830	7/8"	12 Pt. Std. SAE	1.417	1.268	1.969	N/A	0.551	0.866	0.462
80831	15/16"	12 Pt. Std. SAE	1.417	1.346	2.008	N/A	0.630	0.866	0.484
80833	1"	12 Pt. Std. SAE	1.417	1.457	2.047	N/A	0.630	1.181	0.484
80834	1-1/16"	12 Pt. Std. SAE	1.417	1.496	2.047	N/A	0.866	1.181	0.484
80835	1-1/8"	12 Pt. Std. SAE	1.496	1.575	2.047	N/A	0.866	1.181	0.550
80838	1-3/16"	12 Pt. Std. SAE	1.496	1.654	2.126	N/A	0.945	1.260	0.594
80839	1-1/4"	12 Pt. Std. SAE	1.496	1.732	2.205	N/A	0.945	1.299	0.638
80840	1-5/16"	12 Pt. Std. SAE	1.496	1.811	2.205	N/A	1.024	1.299	0.682
80841	1-3/8"	12 Pt. Std. SAE	1.654	1.890	2.283	N/A	1.024	1.378	0.814
80852	1-7/16"	12 Pt. Std. SAE	1.654	1.969	2.283	N/A	1.102	1.378	0.858
80854	1-1/2"	12 Pt. Std. SAE	1.772	2.047	2.362	N/A	1.102	1.417	0.990
80855	1-5/8"	12 Pt. Std. SAE	1.772	2.205	2.520	N/A	1.181	1.575	1.166
80856	1-11/16"	12 Pt. Std. SAE	1.772	2.283	2.559	N/A	1.260	1.535	1.210
80857	1-3/4"	12 Pt. Std. SAE	1.890	2.362	2.598	N/A	1.260	1.575	1.320
80859	1-13/16"	12 Pt. Std. SAE	1.850	2.441	2.677	N/A	1.339	1.575	1.430
80860	1-7/8"	12 Pt. Std. SAE	1.890	2.520	2.756	N/A	1.339	1.654	1.540
80861	2"	12 Pt. Std. SAE	1.890	2.677	2.835	N/A	1.417	1.654	1.628
80862	2-1/8"	12 Pt. Std. SAE	1.890	2.835	2.913	N/A	1.496	1.732	1.804
80863	2-3/16"	12 Pt. Std. SAE	1.890	2.913	2.992	N/A	1.496	1.772	1.914
80864	2-1/4"	12 Pt. Std. SAE	1.890	2.992	2.992	N/A	1.575	1.772	2.024
80865	2-3/8"	12 Pt. Std. SAE	1.890	3.150	3.071	N/A	1.575	1.811	2.200

**LOCKING FLEX GEARWRENCH
PASS-THRU™ RATCHET**



XL PASS-THROUGH

**VORTEX™
BIT SOCKETS**

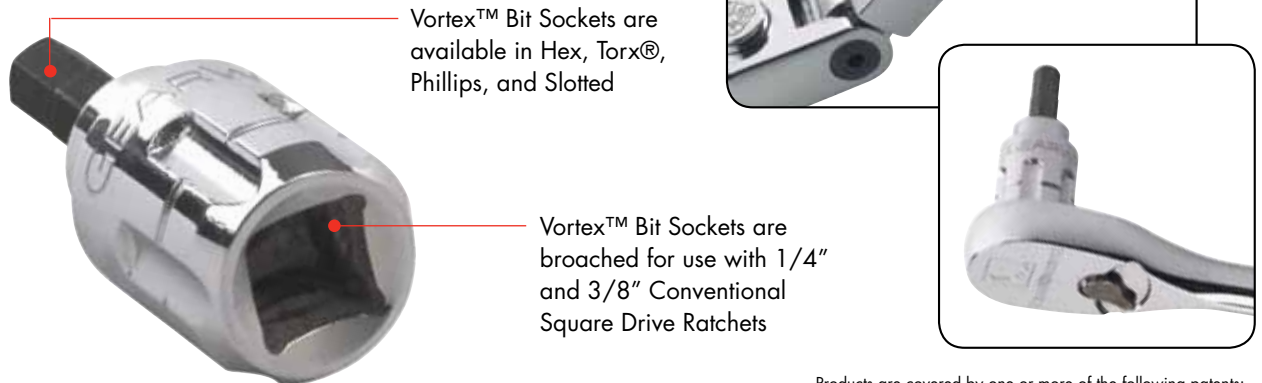

Products are covered by one or more of the following patents:
• US 7,116,346 US 6,868,709 US 7,231,851

SETS

XL PASS-THROUGH



**891427- 27 Pc. SAE/METRIC Pass-Thru®
Ratchet Set Featuring Locking Flex
GearRatchet™ Handle 1/4" DRIVE**

Item No.	Description		
122050	6"	Vortex Extension	1/4" Dr.
122060	3"	Vortex Extension	1/4" Dr.
122070	5.5 mm	Vortex Metric Socket	1/4" Dr.
122080	4.5 mm	Vortex Metric Socket	1/4" Dr.
122090	3.5 mm	Vortex Metric Socket	1/4" Dr.
122100	13 mm	Vortex Metric Socket	1/4" Dr.
122120	12 mm	Vortex Metric Socket	1/4" Dr.

Item No.	Description		
122140	11 mm	Vortex Metric Socket	1/4" Dr.
122160	10 mm	Vortex Metric Socket	1/4" Dr.
122180	9 mm	Vortex Metric Socket	1/4" Dr.
522350	8 mm	Vortex Metric Socket	1/4" Dr.
522040	7 mm	Vortex Metric Socket	1/4" Dr.
522450	6 mm	Vortex Metric Socket	1/4" Dr.
522050	4.5 mm	Vortex Metric Socket	1/4" Dr.
522550	4 mm	Vortex Metric Socket	1/4" Dr.
522060	1/4"	Quick-Release SAE Adapter	1/4" Dr.
522070	9/16"	Vortex SAE Socket	1/4" Dr.
522080	1/2"	Vortex SAE Socket	1/4" Dr.
522090	7/16"	Vortex SAE Socket	1/4" Dr.
522100	3/8"	Vortex SAE Socket	1/4" Dr.
522110	5/16"	Vortex SAE Socket	1/4" Dr.
522120	9/32"	Vortex SAE Socket	1/4" Dr.
522130	1/4"	Vortex SAE Socket	1/4" Dr.
221060	7/32"	Vortex SAE Socket	1/4" Dr.
221080	3/16"	Vortex SAE Socket	1/4" Dr.
231061	5/32"	Vortex SAE Socket	1/4" Dr.
891400	Locking Flex	GearRatchet™ Handle	1/4" Dr.

891226 - 25 Pc. SAE/METRIC Pass-Thru® Ratchet Set Featuring Locking Flex GearRatchet™ Handle 3/8" DRIVE

Item No.	Description		
142200	5/8"	Vortex SAE Socket	3/8" Dr.
142220	1/16"	Vortex SAE Socket	1/2" Dr.
142240	3/4"	Vortex SAE Socket	1/2" Dr.
142260	3/16"	Vortex SAE Socket	1/2" Dr.
142280	7/8"	Vortex SAE Socket	1/2" Dr.
142300	5/16"	Vortex SAE Socket	1/2" Dr.
142320	1"	Vortex SAE Socket	1/2" Dr.
142340	1-1/16"	Vortex SAE Socket	1/2" Dr.
142360	1-1/8"	Vortex SAE Socket	1/2" Dr.
142380	1-1/4"	Vortex SAE Socket	1/2" Dr.
542150	15 mm	Vortex SAE Socket	1/2" Dr.
542160	16 mm	Vortex Metric Socket	1/2" Dr.
542170	17 mm	Vortex Metric Socket	1/2" Dr.
542180	18 mm	Vortex Metric Socket	1/2" Dr.
542190	19 mm	Vortex Metric Socket	1/2" Dr.
542200	20 mm	Vortex Metric Socket	1/2" Dr.
542210	21 mm	Vortex Metric Socket	1/2" Dr.



Item No.	Description		
542220	22 mm	Vortex Metric Socket	1/2" Dr.
542240	24 mm	Vortex Metric Socket	1/2" Dr.
542270	27 mm	Vortex Metric Socket	1/2" Dr.
542300	30 mm	Vortex Metric Socket	1/2" Dr.
542320	32 mm	Vortex Metric Socket	1/2" Dr.
241080	6"	Vortex Metric Socket	1/2" Dr.
241062	1/2" Sq. Dr.	Quick-Release Adapter	1/2" Dr.
891200		Locking Flex GearRatchet™ Adapter	1/2" Dr.

893823 - 23 Pc. SAE/METRIC Pass-Thru® Ratchet Set Featuring Locking Flex GearRatchet™ Handle 1/2" DRIVE

Item No.	Description		
132120	3/8"	Vortex SAE Socket	1/2" Dr.
132140	7/16"	Vortex SAE Socket	3/8" Dr.
132160	1/2"	Vortex SAE Socket	3/8" Dr.
132180	9/16"	Vortex SAE Socket	3/8" Dr.
132200	5/8"	Vortex SAE Socket	3/8" Dr.
132220	1/16"	Vortex SAE Socket	3/8" Dr.
132240	3/4"	Vortex SAE Socket	3/8" Dr.
132260	3/16"	Vortex SAE Socket	3/8" Dr.
132280	7/8"	Vortex SAE Socket	3/8" Dr.
532100	10 mm	Vortex Metric Socket	3/8" Dr.
532110	11 mm	Vortex Metric Socket	3/8" Dr.
532120	12 mm	Vortex Metric Socket	3/8" Dr.
532130	13 mm	Vortex Metric Socket	3/8" Dr.
532140	14 mm	Vortex Metric Socket	3/8" Dr.
532150	15 mm	Vortex Metric Socket	3/8" Dr.



Item No.	Description		
532160	16 mm	Vortex Metric Socket	3/8" Dr.
532170	17 mm	Vortex Metric Socket	3/8" Dr.
532180	8 mm	Vortex Metric Socket	3/8" Dr.
532190	19 mm	Vortex Metric Socket	3/8" Dr.
231060	3"	Vortex Extension	3/8" Dr.
231080	6"	Vortex Extension	3/8" Dr.
231062	3/8" Sq. Dr.	Quick-Release Adapter	3/8" Dr.
893800		Locking Flex GearRatchet™ Adapter	3/8" Dr.

SETS

XL PASS-THROUGH



890040 - 39 Pc. SAE/METRIC Vortex™ Bit Socket Set 1/4" & 3/8" DRIVE

Item No.	Description
89001	#1 Vortex Phillips Phillips Bit Socket 1/4" Dr.
89002	#2 Vortex Phillips Phillips Bit Socket 1/4" Dr.
89003	#3 Vortex Phillips Phillips Bit Socket 1/4" Dr.
89004	1/8" Vortex Slotted SAE Bit Socket 1/4" Dr.
89005	13 mm Vortex Hex Metric Bit Socket 1/4" Dr.
89006	1/4" Vortex Hex SAE Bit Socket 1/4" Dr.
89007	T-8 Vortex Torx® Torx® Bit Socket 1/4" Dr.
89008	T-10 Vortex Torx® Torx® Bit Socket 1/4" Dr.
89009	T-15 Vortex Torx® Torx® Bit Socket 1/4" Dr.
89010	T-20 Vortex Torx® Torx® Bit Socket 1/4" Dr.
89011	T-25 Vortex Torx® Torx® Bit Socket 1/4" Dr.
89012	T-27 Vortex Torx® Torx® Bit Socket 1/4" Dr.
89013	T-30 Vortex Torx® Torx® Bit Socket 1/4" Dr.
89014	1/16" Vortex Hex SAE Bit Socket 1/4" Dr.
89015	5/64" Vortex Hex SAE Bit Socket 1/4" Dr.

Item No.	Description
89016	3/32" Vortex Hex SAE Bit Socket 1/4" Dr.
89017	7/64" Vortex Hex SAE Bit Socket 1/4" Dr.
89018	1/8" Vortex Hex SAE Bit Socket 1/4" Dr.
89019	2 mm Vortex Hex Metric Bit Socket 1/4" Dr.
89020	2.5 mm Vortex Hex Metric Bit Socket 1/4" Dr.
89021	3 mm Vortex Hex Metric Bit Socket 1/4" Dr.
89022	T-470 Vortex Torx® Torx® Bit Socket 3/8" Dr.
89023	T-475 Vortex Torx® Torx® Bit Socket 3/8" Dr.
89024	T-47 Vortex Torx® Torx® Bit Socket 3/8" Dr.
89025	T-50 Vortex Torx® Torx® Bit Socket 3/8" Dr.
89026	T55 Vortex Torx® Torx® Bit Socket 3/8" Dr.
89027	9/64" Vortex Hex SAE Bit Socket 3/8" Dr.
89028	5/32" Vortex Hex SAE Bit Socket 3/8" Dr.
89029	3/16" Vortex Hex SAE Bit Socket 3/8" Dr.
89030	7/32" Vortex Hex SAE Bit Socket 3/8" Dr.
89031	1/4" Vortex Hex SAE Bit Socket 3/8" Dr.
89032	5/16" Vortex Hex SAE Bit Socket 3/8" Dr.
89033	3/8" Vortex Hex Metric Bit Socket 3/8" Dr.
89034	4 mm Vortex Hex Metric Bit Socket 3/8" Dr.
89035	5 mm Vortex Hex Metric Bit Socket 3/8" Dr.
89036	6 mm Vortex Hex Metric Bit Socket 3/8" Dr.
89037	7 mm Vortex Hex Metric Bit Socket 3/8" Dr.
89038	8 mm Vortex Hex Metric Bit Socket 3/8" Dr.
89039	10 mm Vortex Hex Metric Bit Socket 3/8" Dr.



Locking Flex GearRatchet™ Handles

Item No.	Description	Length (inches)	Weight (lbs)
891400	1/4" Dr.	6.50	0.275
893800	3/8" Dr.	12.00	0.858
891200	1/2" Dr.	15.00	1.848

Vortex Sockets 1/4" DRIVE

Item No.	Description	Length (inches)	Weight (lbs)
122050GR	5/32"	0.98	0.019
122060GR	3/16"	0.98	0.019
122070GR	7/32"	0.98	0.02
122080GR	1/4"	0.98	0.022
122090GR	9/32"	1.02	0.023
122100GR	5/16"	1.02	0.024
122120GR	3/8"	1.02	0.024
122140GR	7/16"	1.02	0.031
122160GR	1/2"	1.02	0.036
122180GR	9/16"	1.02	0.037
522350GR	3.5 mm	0.98	0.019
522040GR	4 mm	0.98	0.019
522450GR	4.5 mm	0.98	0.019
522050GR	5 mm	0.98	0.02
522550GR	5.5 mm	0.98	0.021



Item No.	Description	Length (inches)	Weight (lbs)
522060GR	6 mm	0.98	0.022
522070GR	7 mm	1.02	0.023
522080GR	8 mm	1.02	0.024
522090GR	9 mm	1.02	0.025
522100GR	10 mm	1.02	0.028
522110GR	11 mm	1.02	0.031
522120GR	12 mm	1.02	0.035
522130GR	13 mm	1.02	0.037

Vortex Sockets 3/8" DRIVE

Item No.	Description	Length (inches)	Weight (lbs)
132120GR	3/8"	1.26	0.055
132140GR	7/16"	1.26	0.055
132160GR	1/2"	1.26	0.055
132180GR	9/16"	1.26	0.066
132200GR	5/8"	1.26	0.066
132220GR	11/16"	1.26	0.066
132240GR	3/4"	1.30	0.077
132260GR	13/16"	1.38	0.088
132280GR	7/8"	1.38	0.088
532100GR	10 mm	1.26	0.055
532110GR	11 mm	1.26	0.055
532120GR	12 mm	1.26	0.055
532130GR	13 mm	1.26	0.055



Item No.	Description	Length (inches)	Weight (lbs)
532140GR	14 mm	1.26	0.059
532150GR	15 mm	1.26	0.059
532160GR	16 mm	1.26	0.066
532170GR	17 mm	1.26	0.066
532180GR	18 mm	1.26	0.07
532190GR	19 mm	1.30	0.077

OPEN STOCK

XL PASS-THROUGH

OPEN STOCK

XL PASS-THROUGH

Vortex Sockets 1/2" DRIVE

Item No.	Description	Length (inches)	Weight (lbs)
142200GR	5/8"	1.65	0.165
142220GR	11/16"	1.65	0.165
142240GR	3/4"	1.65	0.165
142260GR	13/16"	1.65	0.165
142280GR	7/8"	1.65	0.176
142300GR	15/16"	1.65	0.187
142320GR	1"	1.65	0.209
142340GR	1-1/16"	1.65	0.22
142360GR	1-1/8"	1.77	0.264
142380GR	1-1/4"	1.89	0.308
542150GR	15 mm	1.30	0.165
542160GR	16 mm	1.30	0.165
542170GR	17 mm	1.30	0.165
542180GR	18 mm	1.30	0.165
542190GR	19 mm	1.30	0.165
542200GR	20 mm	1.30	0.172
542210GR	21 mm	1.30	0.172
542220GR	22 mm	1.30	0.176
542240GR	24 mm	1.30	0.187
542300GR	30mm	1.77	0.286
542320GR	32 mm	1.89	0.308
542270GR	27mm	1.30	0.22

Vortex Bit Sockets 1/4" DRIVE

Item No.	Description	Length (inches)	Weight (lbs)
89001	#1 Phillips	1.34	0.033
89002	#2 Phillips	1.34	0.033
89003	#3 Phillips	1.34	0.033
89004	1/8" Slotted	1.34	0.033
89005	3/16" Slotted	1.34	0.033
89006	1/4" Slotted	1.34	0.033
89007	T-8 Torx	1.34	0.033
89008	T-10 Torx	1.34	0.033
89009	T-15 Torx	1.34	0.033
89010	T-20 Torx	1.34	0.033
89011	T-25 Torx	1.34	0.033
89012	T-27 Torx	1.34	0.033
89013	T-30 Torx	1.34	0.033
89014	1/16" Hex	1.34	0.033
89015	5/64" Hex	1.34	0.033
89016	3/32" Hex	1.34	0.033
89017	7/64" Hex	1.34	0.033
89018	1/8" Hex	1.34	0.033

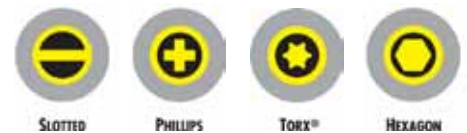

89019	2 mm Hex	1.34	0.033
89020	2.5 mm Hex	1.34	0.033
89021	3 mm Hex	1.34	0.033

Vortex Bit Sockets 3/8" DRIVE

Item No.	Description	Length (inches)	Weight (lbs)
89030	7/32" Hex	1.80	0.132
89039	10 mm Hex	1.80	0.143
89022	T-40 Torx	1.80	0.128
89026	T-55 Torx	1.80	0.143
89027	9/64" Hex	1.80	0.128
89023	T-45 Torx	1.80	0.132
89035	5 mm Hex	1.80	0.128
89037	7 mm Hex	1.80	0.143
89032	5/16" Hex	1.80	0.143
89024	T-47 Torx	1.80	0.132
89028	5/32" Hex	1.80	0.128
89036	6 mm Hex	1.80	0.132
89031	1/4" Hex	1.80	0.143
89034	4 mm Hex	1.80	0.128
89033	3/8" Hex	1.80	0.143
89029	3/16" Hex	1.80	0.132
89025	T-50 Torx	1.80	0.143
89038	8 mm Hex	1.80	0.143
89039	10 mm Hex	1.80	0.143



OPEN STOCK

XL PASS-THROUGH

OPEN STOCK



Pass-Thru® Quick-Release Adapters

Item No.	Description	Length (inches)	Weight (lbs)
231061GR	1/4" Sq. Dr.	0.89	0.275
231062GR	3/8" Sq. Dr.	1.17	0.858
241062GR	1/2" Sq. Dr.	1.57	1.848

XL PASS-THROUGH



Vortex™ Extensions

Item No.	Description	Length (inches)	Weight (lbs)
221060GR	1/4" Vortex Extensions	3.00	0.275
221080GR	1/4" Vortex Extensions	6.00	0.858
241080GR	3/8" Vortex Extensions	3.00	1.848
231060GR	3/8" Vortex Extensions	6.00	0.858
231080GR	1/2" Vortex Extensions	6.00	1.848

BIT SOCKETS & FLEX HEX KEYS













Bit Sockets

- 1/4" Drive Sets
- 1/4" Drive Open Stock
- 3/8" Drive Sets
- 3/8" Drive Open Stock
- 1/2" Drive Sets
- 1/2" Drive Open Stock

Flex Hex™ Keys

**BIT
SOCKETS**

AVAILABLE IN:

 TORX® TAMPER-PROOF	 TORX® PRESS FIT	 INTERNAL TORX®	 EXTERNAL TORX®	 TRIPLE SQUARE
 POZIDRIV®	 BALL HEX	 HEXAGON	 SLOTTED	 PHILLIPS

Ball and Standard Hex in All Sizes



Heat Treated Socket Bases for Durability and Serviceability

Torx® Head Style

Chrome Sockets

Hex Head Style

Packed on Clip Rail Sets



Torx® is a registered trademark of Acument Intellectual Properties, LLC.

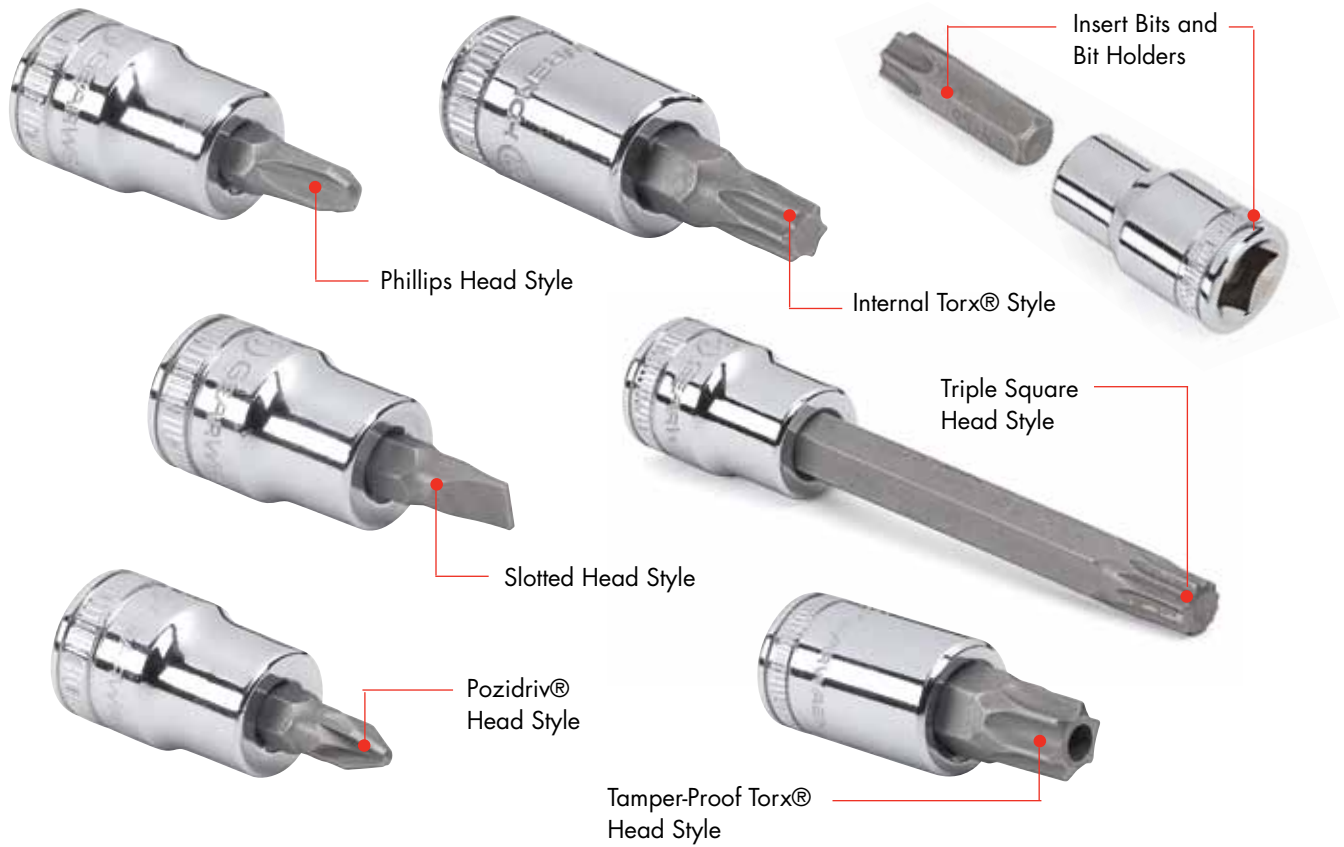

BIT SOCKETS

FLEX HEX™ KEYS

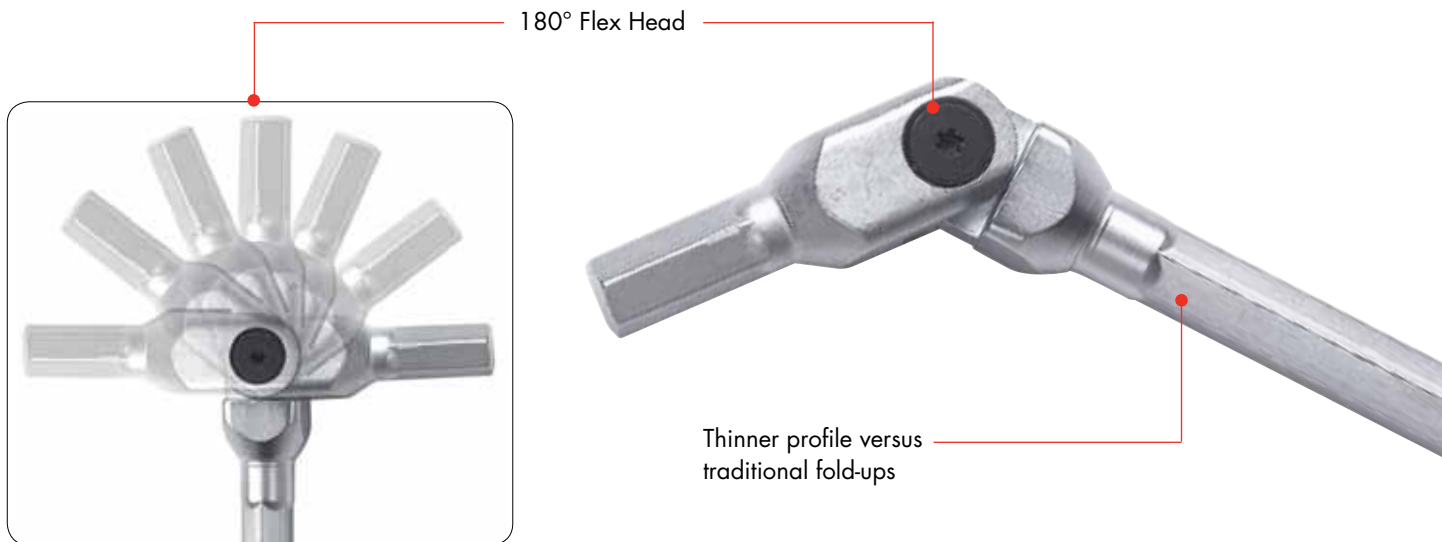

Torx® is a registered trademark of Acument Intellectual Properties, LLC.



80726 - 36 Pc. Master TORX® Set with HEX Bit Sockets 1/4", 3/8" & 1/2" DRIVE

Item No.	Description	
80172	T-10 Torx® Press Fit Bit Socket	1/4" Drive
80173	T-15 Torx® Press Fit Bit Socket	1/4" Drive
80174	T-20 Torx® Press Fit Bit Socket	1/4" Drive
80175	T-25 Torx® Press Fit Bit Socket	1/4" Drive
80176	T-27 Torx® Press Fit Bit Socket	1/4" Drive
80177	T-30 Torx® Press Fit Bit Socket	1/4" Drive
80187	E-5 External Torx® Socket	1/4" Drive
80188	E-6 External Torx® Socket	1/4" Drive
80189	E-7 External Torx® Socket	1/4" Drive
80190	E-8 External Torx® Socket	1/4" Drive
80451	T-40 Torx® Press Fit Bit Socket	3/8" Drive
80452	T-45 Torx® Press Fit Bit Socket	3/8" Drive
80453	T-47 Torx® Press Fit Bit Socket	3/8" Drive
80454	T-50 Torx® Press Fit Bit Socket	3/8" Drive
80455	T-55 Torx® Press Fit Bit Socket	3/8" Drive
80416	5/32" Hex Bit Socket	3/8" Drive
80417	3/16" Hex Bit Socket	3/8" Drive
80418	7/32" Hex Bit Socket	3/8" Drive
80419	1/4" Hex Bit Socket	3/8" Drive
80420	5/16" Hex Bit Socket	3/8" Drive
80421	3/8" Hex Bit Socket	3/8" Drive
80422	2mm Hex Bit Socket	3/8" Drive
80423	2.5mm Hex Bit Socket	3/8" Drive
80424	3mm Hex Bit Socket	3/8" Drive
80425	4mm Hex Bit Socket	3/8" Drive
80426	5mm Hex Bit Socket	3/8" Drive
80427	6mm Hex Bit Socket	3/8" Drive
80428	7mm Hex Bit Socket	3/8" Drive
80429	8mm Hex Bit Socket	3/8" Drive
80430	9mm Hex Bit Socket	3/8" Drive
80431	10mm Hex Bit Socket	3/8" Drive
80460	E-10 External Torx® Socket	3/8" Drive
80461	E-12 External Torx® Socket	3/8" Drive
80462	E-14 External Torx® Socket	3/8" Drive
80463	E-16 External Torx® Socket	3/8" Drive
80669	E-18 External Torx® Socket	1/2" Drive

Torx® is a registered trademark of Acument Intellectual Properties, LLC.

80727 - 36 Pc. Master TORX® Socket Set
1/4", 3/8" & 1/2" DRIVE

Item No.	Description	
80171	T-8 Torx® Press Fit Bit Socket	1/4" Drive
80172	T-10 Torx® Press Fit Bit Socket	1/4" Drive
80173	T-15 Torx® Press Fit Bit Socket	1/4" Drive
80174	T-20 Torx® Press Fit Bit Socket	1/4" Drive
80175	T-25 Torx® Press Fit Bit Socket	1/4" Drive
80176	T-27 Torx® Press Fit Bit Socket	1/4" Drive
80177	T-30 Torx® Press Fit Bit Socket	1/4" Drive
80178	T-7 Torx® Tamper-Proof Bit Socket	1/4" Drive
80179	T-8 Torx® Tamper-Proof Bit Socket	1/4" Drive
80180	T-10 Torx® Tamper-Proof Bit Socket	1/4" Drive
80181	T-15 Torx® Tamper-Proof Bit Socket	1/4" Drive
80182	T-20 Torx® Tamper-Proof Bit Socket	1/4" Drive
80183	T-25 Torx® Tamper-Proof Bit Socket	1/4" Drive
80184	T-27 Torx® Tamper-Proof Bit Socket	1/4" Drive
80185	T-30 Torx® Tamper-Proof Bit Socket	1/4" Drive
80186	E-4 External Torx® Socket	1/4" Drive
80187	E-5 External Torx® Socket	1/4" Drive
80188	E-6 External Torx® Socket	1/4" Drive
80189	E-7 External Torx® Socket	1/4" Drive
80190	E-8 External Torx® Socket	1/4" Drive
80451	T-40 Torx® Press Fit Bit Socket	3/8" Drive
80452	T-45 Torx® Press Fit Bit Socket	3/8" Drive
80453	T-47 Torx® Press Fit Bit Socket	3/8" Drive
80454	T-50 Torx® Press Fit Bit Socket	3/8" Drive
80455	T-55 Torx® Press Fit Bit Socket	3/8" Drive
80456	T-40 Torx® Tamper-Proof Bit Socket	3/8" Drive
80457	T-45 Torx® Tamper-Proof Bit Socket	3/8" Drive
80458	T-50 Torx® Tamper-Proof Bit Socket	3/8" Drive
80459	T-55 Torx® Tamper-Proof Bit Socket	3/8" Drive
80460	E-10 External Torx® Socket	3/8" Drive
80461	E-12 External Torx® Socket	3/8" Drive
80462	E-14 External Torx® Socket	3/8" Drive
80463	E-16 External Torx® Socket	3/8" Drive
80669	E-18 External Torx® Socket	1/2" Drive
80670	E-20 External Torx® Socket	1/2" Drive
80667	T-60 Torx® Press Fit Bit Socket	1/2" Drive



MULTI DRIVE SETS

BIT SOCKETS

Torx® is a registered trademark of Acument Intellectual Properties, LLC.

MULTI DRIVE SETS
BIT SOCKETS



TORX® PRESS FIT

80723 - 13 Pc. TORX® Press Fit Bit Socket Set

Item No.	Description	
80171	T-8 Torx® Press Fit Bit Socket	1/4" Drive
80172	T-10 Torx® Press Fit Bit Socket	1/4" Drive
80173	T-15 Torx® Press Fit Bit Socket	1/4" Drive
80174	T-20 Torx® Press Fit Bit Socket	1/4" Drive
80175	T-25 Torx® Press Fit Bit Socket	1/4" Drive
80176	T-27 Torx® Press Fit Bit Socket	1/4" Drive
80177	T-30 Torx® Press Fit Bit Socket	1/4" Drive
80451	T-40 Torx® Press Fit Bit Socket	3/8" Drive
80452	T-45 Torx® Press Fit Bit Socket	3/8" Drive
80453	T-47 Torx® Press Fit Bit Socket	3/8" Drive
80454	T-50 Torx® Press Fit Bit Socket	3/8" Drive
80455	T-55 Torx® Press Fit Bit Socket	3/8" Drive
80667	T-60 Torx® Press Fit Bit Socket	1/2" Drive



TORX® TAMPER-PROOF

80725 - 13 Pc. TORX® Tamper-Proof Bit Socket Set

Item No.	Description	
80178	T-7 Torx® Tamper-Proof Bit Socket	1/4" Drive
80179	T-8 Torx® Tamper-Proof Bit Socket	1/4" Drive
80180	T-10 Torx® Tamper-Proof Bit Socket	1/4" Drive
80181	T-15 Torx® Tamper-Proof Bit Socket	1/4" Drive
80182	T-20 Torx® Tamper-Proof Bit Socket	1/4" Drive
80183	T-25 Torx® Tamper-Proof Bit Socket	1/4" Drive
80184	T-27 Torx® Tamper-Proof Bit Socket	1/4" Drive
80185	T-30 Torx® Tamper-Proof Bit Socket	1/4" Drive
80456	T-40 Torx® Tamper-Proof Bit Socket	3/8" Drive
80457	T-45 Torx® Tamper-Proof Bit Socket	3/8" Drive
80458	T-50 Torx® Tamper-Proof Bit Socket	3/8" Drive
80459	T-55 Torx® Tamper-Proof Bit Socket	3/8" Drive
80668	T-60 Torx® Tamper-Proof Bit Socket	1/2" Drive



EXTERNAL TORX®

80583 - 13 Pc. External TORX® Socket Set

Item No.	Description	
80186	E-4 External Torx® Socket	1/4" Drive
80187	E-5 External Torx® Socket	1/4" Drive
80188	E-6 External Torx® Socket	1/4" Drive
80189	E-7 External Torx® Socket	1/4" Drive
80190	E-8 External Torx® Socket	1/4" Drive
80460	E-10 External Torx® Socket	3/8" Drive
80461	E-12 External Torx® Socket	3/8" Drive
80462	E-14 External Torx® Socket	3/8" Drive
80463	E-16 External Torx® Socket	3/8" Drive
80669	E-18 External Torx® Socket	1/2" Drive
80670	E-20 External Torx® Socket	1/2" Drive
80672	E-22 External Torx® Socket	1/2" Drive
80673	E-24 External Torx® Socket	1/2" Drive

Torx® is a registered trademark of Acument Intellectual Properties, LLC.

80724 - 11 Pc. TORX® Tamper-Proof Bit Socket Set 1/4" & 3/8" DRIVE

Item No.	Description
80471	T-10 Torx® Tamper-Proof Internal Torx® Bit
80472	T-15 Torx® Tamper-Proof Internal Torx® Bit
80473	T-20 Torx® Tamper-Proof Internal Torx® Bit
80474	T-25 Torx® Tamper-Proof Internal Torx® Bit
80475	T-27 Torx® Tamper-Proof Internal Torx® Bit
80476	T-30 Torx® Tamper-Proof Internal Torx® Bit
80477	T-40 Torx® Tamper-Proof Internal Torx® Bit
80478	T-45 Torx® Tamper-Proof Internal Torx® Bit
80479	T-50 Torx® Tamper-Proof Internal Torx® Bit
80480	1/4" Bit Adapter 3/8" Drive
80481	5/16" Bit Adapter 3/8" Drive



80722 - 10 Pc. TORX® Press Fit Bit Socket Set 1/4" & 3/8" DRIVE

Item No.	Description	
80172	T-10 Torx® Press Fit Bit Socket	1/4" Drive
80173	T-15 Torx® Press Fit Bit Socket	1/4" Drive
80174	T-20 Torx® Press Fit Bit Socket	1/4" Drive
80175	T-25 Torx® Press Fit Bit Socket	1/4" Drive
80176	T-27 Torx® Press Fit Bit Socket	1/4" Drive
80177	T-30 Torx® Press Fit Bit Socket	1/4" Drive
80451	T-40 Torx® Press Fit Bit Socket	3/8" Drive
80452	T-45 Torx® Press Fit Bit Socket	3/8" Drive
80454	T-50 Torx® Press Fit Bit Socket	3/8" Drive
80455	T-55 Torx® Press Fit Bit Socket	3/8" Drive



80588 - 10 Pc. Long TORX® Bit Socket Set 1/4" & 3/8" DRIVE

Item No.	Description	
82510	T-8 Long Torx® Bit Socket	1/4" Drive
82511	T-10 Long Torx® Bit Socket	1/4" Drive
82512	T-15 Long Torx® Bit Socket	1/4" Drive
82513	T-20 Long Torx® Bit Socket	1/4" Drive
82514	T-25 Long Torx® Bit Socket	1/4" Drive
82515	T-27 Long Torx® Bit Socket	1/4" Drive
82516	T-30 Long Torx® Bit Socket	1/4" Drive
82517	T-40 Long Torx® Bit Socket	3/8" Drive
82518	T-45 Long Torx® Bit Socket	3/8" Drive
82519	T-50 Long Torx® Bit Socket	3/8" Drive



Torx® is a registered trademark of Acument Intellectual Properties, LLC.



80582 - 10 Pc. External TORX® Socket Set
1/4", 3/8" & 1/2" DRIVE

Item No.	Description	
80186	E-4 External Torx® Socket	1/4" Drive
80187	E-5 External Torx® Socket	1/4" Drive
80188	E-6 External Torx® Socket	1/4" Drive
80189	E-7 External Torx® Socket	1/4" Drive
80190	E-8 External Torx® Socket	1/4" Drive
80460	E-10 External Torx® Socket	1/4" Drive
80461	E-12 External Torx® Socket	3/8" Drive
80462	E-14 External Torx® Socket	3/8" Drive
80463	E-16 External Torx® Socket	3/8" Drive
80669	E-18 External Torx® Socket	1/2" Drive

MULTI DRIVE SETS

BIT SOCKETS



80579 - 10 Pc. SAE HEX Bit Socket Set
3/8" & 1/2" DRIVE

Item No.	Description	
80414	1/8" Hex Bit Socket	3/8" Drive
80416	5/32" Hex Bit Socket	3/8" Drive
80417	3/16" Hex Bit Socket	3/8" Drive
80418	7/32" Hex Bit Socket	3/8" Drive
80419	1/4" Hex Bit Socket	3/8" Drive
80420	5/16" Hex Bit Socket	3/8" Drive
80421	3/8" Hex Bit Socket	3/8" Drive
80654	1/2" Hex Bit Socket	1/2" Drive
80655	9/16" Hex Bit Socket	1/2" Drive
80656	5/8" Hex Bit Socket	1/2" Drive



80578 - 10 Pc. METRIC HEX Bit Socket Set
3/8" & 1/2" DRIVE

Item No.	Description	
80425	4mm Hex Bit Socket	3/8" Drive
80426	5mm Hex Bit Socket	3/8" Drive
80427	6mm Hex Bit Socket	3/8" Drive
80428	7mm Hex Bit Socket	3/8" Drive
80429	8mm Hex Bit Socket	3/8" Drive
80430	9mm Hex Bit Socket	3/8" Drive
80431	10mm Hex Bit Socket	3/8" Drive
80661	12mm Hex Bit Socket	1/2" Drive
80662	14mm Hex Bit Socket	1/2" Drive
80663	17mm Hex Bit Socket	1/2" Drive

Torx® is a registered trademark of Acument Intellectual Properties, LLC.

80572 - 4 Pc. METRIC TRIPLE SQUARE Bit Socket Set 3/8" & 1/2" DRIVE

Item No.	Description	
80449	6mm Triple Square Bit Socket	3/8" Drive
80450	8mm Triple Square Bit Socket	3/8" Drive
80665	10mm Triple Square Bit Socket	1/2" Drive
80666	12mm Triple Square Bit Socket	1/2" Drive



80323 - 10 Pc. SAE HEX Bit Socket Set 1/4" DRIVE

Item No.	Description	
80151	1/16" Hex Bit Socket	1/4" Drive
80152	5/64" Hex Bit Socket	1/4" Drive
80153	3/32" Hex Bit Socket	1/4" Drive
80154	7/64" Hex Bit Socket	1/4" Drive
80155	1/8" Hex Bit Socket	1/4" Drive
80156	9/64" Hex Bit Socket	1/4" Drive
80157	5/32" Hex Bit Socket	1/4" Drive
80158	3/16" Hex Bit Socket	1/4" Drive
80159	7/32" Hex Bit Socket	1/4" Drive
80160	1/4" Hex Bit Socket	1/4" Drive



80321 - 6 Pc. METRIC HEX Bit Socket Set 1/4" DRIVE

Item No.	Description	
80161	2mm Hex Bit Socket	1/4" Drive
80162	2.5mm Hex Bit Socket	1/4" Drive
80163	3mm Hex Bit Socket	1/4" Drive
80164	4mm Hex Bit Socket	1/4" Drive
80165	5mm Hex Bit Socket	1/4" Drive
80166	6mm Hex Bit Socket	1/4" Drive





**80322 - 6 Pc. DEEP External TORX® Socket Set
1/4" DRIVE**

Item No.	Description	
80191	E-4 Deep External Torx® Socket	1/4" Drive
80192	E-5 Deep External Torx® Socket	1/4" Drive
80193	E-6 Deep External Torx® Socket	1/4" Drive
80194	E-7 Deep External Torx® Socket	1/4" Drive
80195	E-8 Deep External Torx® Socket	1/4" Drive
80196	E-10 Deep External Torx® Socket	1/4" Drive



**80320 - 4 Pc. METRIC TRIPLE SQUARE
Bit Socket Set 1/4" DRIVE**

Item No.	Description	
80167	4mm Triple Square Bit Socket	1/4" Drive
80168	5mm Triple Square Bit Socket	1/4" Drive
80169	6mm Triple Square Bit Socket	1/4" Drive
80170	8mm Triple Square Bit Socket	1/4" Drive



**80581 - 12 Pc. SAE HEX Bit Socket Set
3/8" DRIVE**

Item No.	Description	
80410	1/16" Hex Bit Socket	3/8" Drive
80411	5/64" Hex Bit Socket	3/8" Drive
80412	3/32" Hex Bit Socket	3/8" Drive
80413	7/64" Hex Bit Socket	3/8" Drive
80414	1/8" Hex Bit Socket	3/8" Drive
80415	9/64" Hex Bit Socket	3/8" Drive
80416	5/32" Hex Bit Socket	3/8" Drive
80417	3/16" Hex Bit Socket	3/8" Drive
80418	7/32" Hex Bit Socket	3/8" Drive
80419	1/4" Hex Bit Socket	3/8" Drive
80420	5/16" Hex Bit Socket	3/8" Drive
80421	3/8" Hex Bit Socket	3/8" Drive

Torx® is a registered trademark of Acument Intellectual Properties, LLC.

**80580 - 12 Pc. METRIC HEX Bit Socket Set
3/8" DRIVE**

Item No.	Description	
80422	2mm Hex Bit Socket	3/8" Drive
80423	2.5mm Hex Bit Socket	3/8" Drive
80424	3mm Hex Bit Socket	3/8" Drive
80425	4mm Hex Bit Socket	3/8" Drive
80426	5mm Hex Bit Socket	3/8" Drive
80427	6mm Hex Bit Socket	3/8" Drive
80428	7mm Hex Bit Socket	3/8" Drive
80429	8mm Hex Bit Socket	3/8" Drive
80430	9mm Hex Bit Socket	3/8" Drive
80431	10mm Hex Bit Socket	3/8" Drive
80432	11mm Hex Bit Socket	3/8" Drive
80433	12mm Hex Bit Socket	3/8" Drive



**80586 - 7 Pc. SAE BALL HEX Bit Socket Set
3/8" DRIVE**

Item No.	Description	
80539	1/8" Ball Hex Bit Socket	3/8" Drive
80540	5/32" Ball Hex Bit Socket	3/8" Drive
80541	3/16" Ball Hex Bit Socket	3/8" Drive
80542	7/32" Ball Hex Bit Socket	3/8" Drive
80543	1/4" Ball Hex Bit Socket	3/8" Drive
80544	5/16" Ball Hex Bit Socket	3/8" Drive
80545	3/8" Ball Hex Bit Socket	3/8" Drive



**80587 - 7 Pc. METRIC BALL HEX Bit Socket Set
3/8" DRIVE**

Item No.	Description	
82500	4mm Ball Hex Bit Socket	3/8" Drive
82501	5mm Ball Hex Bit Socket	3/8" Drive
82502	6mm Ball Hex Bit Socket	3/8" Drive
82503	7mm Ball Hex Bit Socket	3/8" Drive
82504	8mm Ball Hex Bit Socket	3/8" Drive
82505	9mm Ball Hex Bit Socket	3/8" Drive
82506	10mm Ball Hex Bit Socket	3/8" Drive



3/8" DRIVE SETS

BIT SOCKETS



80573 - 8 Pc. METRIC LONG BALL HEX Bit Socket Set 3/8" DRIVE

Item No.	Description	
80441	3mm Long Ball Hex Bit Socket	3/8" Drive
80442	4mm Long Ball Hex Bit Socket	3/8" Drive
80443	5mm Long Ball Hex Bit Socket	3/8" Drive
80444	6mm Long Ball Hex Bit Socket	3/8" Drive
80445	7mm Long Ball Hex Bit Socket	3/8" Drive
80446	8mm Long Ball Hex Bit Socket	3/8" Drive
80447	9mm Long Ball Hex Bit Socket	3/8" Drive
80448	10mm Long Ball Hex Bit Socket	3/8" Drive



80574 - 7 Pc. SAE LONG BALL HEX Bit Socket Set 3/8" DRIVE

Item No.	Description	
80434	1/8" Long Ball Hex Bit Socket	3/8" Drive
80435	5/32" Long Ball Hex Bit Socket	3/8" Drive
80436	3/16" Long Ball Hex Bit Socket	3/8" Drive
80437	7/32" Long Ball Hex Bit Socket	3/8" Drive
80438	1/4" Long Ball Hex Bit Socket	3/8" Drive
80439	5/16" Long Ball Hex Bit Socket	3/8" Drive
80440	3/8" Long Ball Hex Bit Socket	3/8" Drive



80577 - 7 Pc. SCREWDRIVER Bit Socket Set 3/8" DRIVE

Item No.	Description	
80464	4mm Slotted Screwdriver Bit Socket	3/8" Drive
80465	5mm Slotted Screwdriver Bit Socket	3/8" Drive
80466	6mm Slotted Screwdriver Bit Socket	3/8" Drive
80467	#1 Phillips Screwdriver Bit Socket	3/8" Drive
80468	#2 Phillips Screwdriver Bit Socket	3/8" Drive
80469	#3 Phillips Screwdriver Bit Socket	3/8" Drive
80470	#2 Pozidriv® Screwdriver Bit Socket	3/8" Drive



**80571 - 3 Pc. TORX® BRAKE Bit Socket Set
3/8" DRIVE**

Item No.	Description	
80451	T-40 Torx® Press Fit Bit Socket	3/8" Drive
80452	T-45 Torx® Press Fit Bit Socket	3/8" Drive
80454	T-50 Torx® Press Fit Bit Socket	3/8" Drive



**80570 - 3 Pc. HEX SAE/METRIC Bit Socket Set
3/8" DRIVE**

Item No.	Description	
80419	1/4" Hex Bit Socket	3/8" Drive
80421	3/8" Hex Bit Socket	3/8" Drive
80429	8mm Hex Bit Socket	3/8" Drive



80721 - 7 Pc. SAE HEX Bit Socket Set 1/2" DRIVE

Item No.	Description	
80651	5/16" Hex Bit Socket	1/2" Drive
80652	3/8" Hex Bit Socket	1/2" Drive
80653	7/16" Hex Bit Socket	1/2" Drive
80654	1/2" Hex Bit Socket	1/2" Drive
80655	9/16" Hex Bit Socket	1/2" Drive
80656	5/8" Hex Bit Socket	1/2" Drive
80657	3/4" Hex Bit Socket	1/2" Drive



**80720 - 7 Pc. METRIC HEX Bit Socket Set
1/2" DRIVE**

Item No.	Description	
80658	6mm Hex Bit Socket	1/2" Drive
80659	8mm Hex Bit Socket	1/2" Drive
80660	10mm Hex Bit Socket	1/2" Drive
80661	12mm Hex Bit Socket	1/2" Drive
80662	14mm Hex Bit Socket	1/2" Drive
80663	17mm Hex Bit Socket	1/2" Drive
80664	19mm Hex Bit Socket	1/2" Drive



Torx® is a registered trademark of Acument Intellectual Properties, LLC.

3/8" DRIVE SETS
BIT SOCKETS

1/4" OPEN STOCK
BIT SOCKETS



HEX Bit Sockets 1/4" Drive

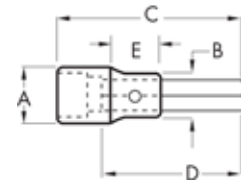

Item No.	Bit Size	Drive End (inch) A	Nose Dia. (inch) B	Overall Length (inch) C	Bit Length (inch) D	Length to Shoulder E	Weight (lbs)
80151	1/16"	0.508	0.508	1.530	0.984	N/A	0.059
80152	5/64"	0.508	0.508	1.530	0.984	N/A	0.059
80153	3/32"	0.508	0.508	1.530	0.984	N/A	0.059
80154	7/64"	0.508	0.508	1.530	0.984	N/A	0.059
80155	1/8"	0.508	0.508	1.530	0.984	N/A	0.059
80156	9/64"	0.508	0.508	1.530	0.984	N/A	0.059
80157	5/32"	0.508	0.508	1.530	0.984	N/A	0.059
80158	3/16"	0.508	0.508	1.530	0.984	N/A	0.059
80159	7/32"	0.508	0.508	1.530	0.984	N/A	0.059
80160	1/4"	0.508	0.508	1.530	0.984	N/A	0.059
80161	2 mm	0.508	0.508	1.530	0.984	N/A	0.059
80162	2.5 mm	0.508	0.508	1.530	0.984	N/A	0.059
80163	3 mm	0.508	0.508	1.530	0.984	N/A	0.059
80164	4 mm	0.508	0.508	1.530	0.984	N/A	0.059
80165	5 mm	0.508	0.508	1.530	0.984	N/A	0.059
80166	6 mm	0.508	0.508	1.530	0.984	N/A	0.059



TRIPLE SQUARE Bit Socket

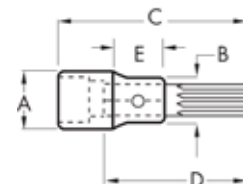

Item No.	Bit Size	Drive End (inch) A	Nose Dia. (inch) B	Overall Length (inch) C	Bit Length (inch) D	Length to Shoulder E	Weight (lbs)
80167	4 mm	0.508	0.508	1.290	0.748	N/A	0.070
80168	5 mm	0.508	0.508	1.290	0.748	N/A	0.070
80169	6 mm	0.508	0.508	1.290	0.748	N/A	0.070
80170	8 mm	0.560	0.560	1.290	0.748	N/A	0.070

TORX® Press Fit Bit Sockets 1/4" DRIVE

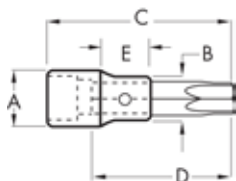

Item No.	Torx® Opening	Drive End (inch) A	Nose Dia. (inch) B	Overall Length (inch) C	Bit Length (inch) D	Length to Shoulder E	Weight (lbs)
80171	T-8	0.508	0.508	1.530	0.984	N/A	0.059
80172	T-10	0.508	0.508	1.530	0.984	N/A	0.059
80173	T-15	0.508	0.508	1.530	0.984	N/A	0.059
80174	T-20	0.508	0.508	1.530	0.984	N/A	0.059
80175	T-25	0.508	0.508	1.530	0.984	N/A	0.059
80176	T-27	0.508	0.508	1.530	0.984	N/A	0.059
80177	T-30	0.508	0.508	1.530	0.984	N/A	0.059

TORX® Tamper-Proof Bit Sockets 1/4" DRIVE

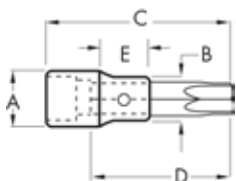

Item No.	Torx® Opening	Drive End (inch) A	Nose Dia. (inch) B	Overall Length (inch) C	Bit Length (inch) D	Length to Shoulder E	Weight (lbs)
80178	T-7	0.508	0.508	1.530	0.984	N/A	0.059
80179	T-8	0.508	0.508	1.530	0.984	N/A	0.059
80180	T-10	0.508	0.508	1.530	0.984	N/A	0.059
80181	T-15	0.508	0.508	1.530	0.984	N/A	0.059
80182	T-20	0.508	0.508	1.530	0.984	N/A	0.059
80183	T-25	0.508	0.508	1.530	0.984	N/A	0.059
80184	T-27	0.508	0.508	1.530	0.984	N/A	0.059
80185	T-30	0.508	0.508	1.530	0.984	N/A	0.059

Torx® is a registered trademark of Acument Intellectual Properties, LLC.

1/4" OPEN STOCK

BIT SOCKETS

BIT SOCKETS
1/4" OPEN STOCK



External TORX® Sockets 1/4" DRIVE

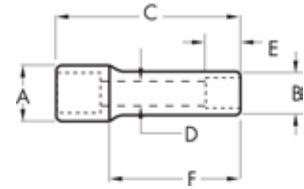

Item No.	Torx® Opening	Drive End (inch) A	Wrench End (inch) B	Overall Length (inch) C	Bolt End Clearance D	Bolt Depth E	Length to Shoulder F	Weight (lbs)
80186	E-4	0.508	0.251	0.984	0.078	0.137	0.421	0.044
80187	E-5	0.508	0.295	0.984	0.098	0.196	0.421	0.044
80188	E-6	0.508	0.322	0.984	0.110	0.255	0.421	0.046
80189	E-7	0.508	0.370	0.984	0.150	0.255	0.421	0.046
80190	E-8	0.508	0.437	0.984	0.150	0.255	0.421	0.046



DEEP External TORX® Sockets 1/4" DRIVE

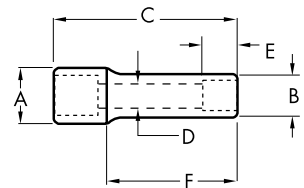

Item No.	Torx® Opening	Drive End (inch) A	Wrench End (inch) B	Overall Length (inch) C	Bolt Clearance D	Bolt Depth E	Length to Shoulder F	Weight (lbs)
80191	E-4	0.470	0.224	1.968	0.078	0.157	1.405	0.057
80192	E-5	0.470	0.275	1.968	0.098	0.216	1.405	0.057
80193	E-6	0.470	0.314	1.968	0.118	0.255	1.405	0.057
80194	E-7	0.470	0.354	1.968	0.157	0.275	1.405	0.057
80195	E-8	0.470	0.393	1.968	0.157	0.393	1.405	0.068
80196	E-10	0.470	0.470	1.968	0.216	0.590	0.000	0.068

Torx® is a registered trademark of Acument Intellectual Properties, LLC.

80480 - 1/4" Bit Holder Socket
Open Stock - Tamper-Proof Internal Torx® Bits



Bit Holder works with the following insert bits:



Item No.	Bit Size	Bit Holder Size	Overall Length (inch) C	Bit Length (inch) D	Weight (lbs)
80471	T-10	1/4"	0.984	0.984	0.011
80472	T-15	1/4"	0.984	0.984	0.011
80473	T-20	1/4"	0.984	0.984	0.011
80474	T-25	1/4"	0.984	0.984	0.011
80475	T-27	1/4"	0.984	0.984	0.011
80476	T-30	1/4"	0.984	0.984	0.011

LONG TORX® Bit Sockets 1/4" DRIVE

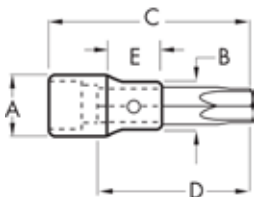

Item No.	Bit Size	Drive End (inch) A	Nose Dia. (inch) B	Overall Length (inch) C	Bit Length (inch) D	Length to Shoulder (inch) E	Weight (lbs)
82510	T-8	0.508	0.508	5.980	5.393	0.551	0.123
82511	T-10	0.508	0.508	5.980	5.393	0.551	0.123
82512	T-15	0.508	0.508	5.980	5.393	0.551	0.125
82513	T-20	0.508	0.508	5.980	5.393	0.551	0.125
82514	T-25	0.508	0.508	5.980	5.393	0.551	0.123
82515	T-27	0.508	0.508	5.980	5.393	0.551	0.127
82516	T-30	0.508	0.508	5.980	5.393	0.551	0.127

Torx® is a registered trademark of Acument Intellectual Properties, LLC.



HEX Bit Sockets 3/8" DRIVE

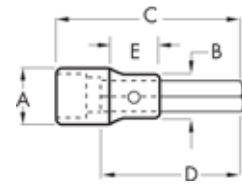

BIT SOCKETS 3/8" OPEN STOCK

Item No.	Bit Size	Drive End (inch) A	Nose Dia. (inch) B	Overall Length (inch) C	Bit Length (inch) D	Length to Shoulder E	Weight (lbs)
80410	1/16"	0.688	0.590	1.653	0.984	0.551	0.092
80411	5/64"	0.688	0.590	1.653	0.984	0.551	0.092
80412	3/32"	0.688	0.590	1.653	0.984	0.551	0.092
80413	7/64"	0.688	0.590	1.653	0.984	0.551	0.092
80414	1/8"	0.688	0.590	1.653	0.984	0.551	0.092
80415	9/64"	0.688	0.590	1.653	0.984	0.551	0.094
80416	5/32"	0.688	0.590	1.653	0.984	0.551	0.094
80417	3/16"	0.688	0.590	1.653	0.984	0.551	0.094
80418	7/32"	0.688	0.590	1.653	0.984	0.551	0.099
80419	1/4"	0.688	0.590	1.653	0.984	0.551	0.099
80420	5/16"	0.688	0.590	1.850	1.181	0.551	0.107
80421	3/8"	0.750	0.750	1.181	1.181	0.000	0.158
80422	2 mm	0.688	0.590	1.653	0.984	0.551	0.092
80423	2.5 mm	0.688	0.590	1.653	0.984	0.551	0.092
80424	3 mm	0.688	0.590	1.653	0.984	0.551	0.092
80425	4 mm	0.688	0.590	1.653	0.984	0.551	0.094
80426	5 mm	0.688	0.590	1.653	0.984	0.551	0.099
80427	6 mm	0.688	0.590	1.653	0.984	0.551	0.099
80428	7 mm	0.688	0.590	1.850	1.181	0.551	0.107
80429	8 mm	0.688	0.590	1.850	1.181	0.551	0.107
80430	9 mm	0.750	0.750	1.968	1.181	0.551	0.160
80431	10 mm	0.750	0.750	1.968	1.181	0.551	0.162
80432	11 mm	0.750	0.750	1.968	1.181	0.551	0.165
80433	12 mm	0.750	0.750	1.968	1.181	0.551	0.173

LONG BALL HEX Bit Sockets 3/8" DRIVE

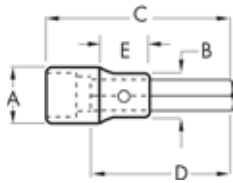

Item No.	Bit Size	Drive End (inch) A	Nose Dia. (inch) B	Overall Length (inch) C	Bit Length (inch) D	Length to Shoulder E	Weight (lbs)
80434	1/8"	0.688	0.590	5.984	5.196	0.551	0.112
80435	5/32"	0.688	0.590	5.984	5.196	0.551	0.112
80436	3/16"	0.688	0.590	5.984	5.196	0.551	0.129
80437	7/32"	0.688	0.590	5.984	5.275	0.551	0.149
80438	1/4"	0.688	0.590	5.984	5.393	0.551	0.158
80439	5/16"	0.688	0.590	5.984	5.393	0.551	0.204
80440	3/8"	0.750	0.750	5.984	5.275	0.551	0.294
80441	3 mm	0.688	0.590	5.984	5.196	0.551	0.112
80442	4 mm	0.688	0.590	5.984	5.196	0.551	0.112
80443	5 mm	0.688	0.590	5.984	5.196	0.551	0.129
80444	6 mm	0.688	0.590	5.984	5.314	0.551	0.149
80445	7 mm	0.688	0.590	5.984	5.393	0.551	0.204
80446	8 mm	0.688	0.590	5.984	5.393	0.551	0.204
80447	9 mm	0.750	0.750	5.984	5.275	0.551	0.396
80448	10 mm	0.750	0.750	5.984	5.275	0.551	0.396

3/8" OPEN STOCK

BIT SOCKETS

BIT SOCKETS 3/8" OPEN STOCK



BALL HEX Bit Sockets 3/8" DRIVE

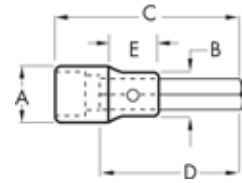

Item No.	Bit Size	Drive End (inch) A	Nose Dia. (inch) B	Overall Length (inch) C	Bit Length (inch) D	Length to Shoulder E	Weight (lbs)
80539	1/8"	0.688	0.590	1.653	0.984	0.551	0.105
80540	5/32"	0.688	0.590	1.653	0.984	0.551	0.105
80541	3/16"	0.688	0.590	1.653	0.984	0.551	0.105
80542	7/32"	0.688	0.590	1.653	0.984	0.551	0.105
80543	1/4"	0.688	0.590	1.653	0.984	0.551	0.105
80544	5/16"	0.688	0.590	1.653	1.181	0.551	0.105
80545	3/8"	0.750	0.750	1.968	1.181	0.000	0.105
82500	4 mm	0.688	0.590	1.654	0.984	0.551	0.105
82501	5 mm	0.688	0.590	1.654	0.984	0.551	0.105
82502	6 mm	0.688	0.590	1.654	0.984	0.551	0.105
82503	7 mm	0.688	0.590	1.850	1.181	0.551	0.105
82504	8 mm	0.688	0.590	1.850	1.181	0.551	0.105
82505	9 mm	0.750	0.750	0.968	1.181	0.551	0.105
82506	10 mm	0.750	0.750	0.968	1.181	0.551	0.105



TRIPLE SQUARE Bit Sockets 3/8" DRIVE

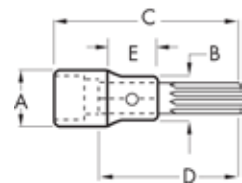

Item No.	Bit Size	Drive End (inch) A	Nose Dia. (inch) B	Overall Length (inch) C	Bit Length (inch) D	Length to Shoulder E	Weight (lbs)
80449	6 mm	0.69	5/16"	3.15	2.48	0.55	0.116
80450	8 mm	0.69	5/16"	3.66	3.66	0.55	0.131

TORX® Press Fit Bit Sockets 3/8" DRIVE

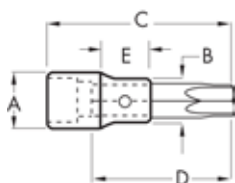

Item No.	Bit Size	Drive End (inch) A	Nose Dia. (inch) B	Overall Length (inch) C	Bit Length (inch) D	Length to Shoulder E	Weight (lbs)
80534	T-15	0.688	0.590	0.984	1.181	0.551	0.105
80535	T-20	0.688	0.590	0.984	1.181	0.551	0.105
80536	T-25	0.688	0.590	0.984	1.181	0.551	0.105
80537	T-27	0.688	0.590	0.984	1.181	0.551	0.105
80538	T-30	0.688	0.590	0.984	1.181	0.551	0.105
80451	T-40	0.688	0.590	1.850	1.181	0.551	0.105
80452	T-45	0.688	0.590	1.850	1.181	0.551	0.105
80453	T-47	0.688	0.590	1.850	1.181	0.551	0.105
80454	T-50	0.688	0.590	1.850	1.181	0.551	0.105
80455	T-55	0.750	0.750	1.968	1.181	0.551	0.158

TORX® Tamper-Proof Bit Sockets 3/8" DRIVE

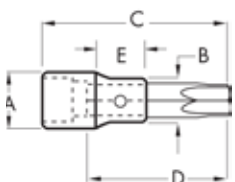

Item No.	Bit Size	Drive End (inch) A	Nose Dia. (inch) B	Overall Length (inch) C	Bit Length (inch) D	Length to Shoulder E	Weight (lbs)
80456	T-40	0.688	0.590	1.850	1.181	0.551	0.105
80457	T-45	0.688	0.590	1.850	1.181	0.551	0.105
80458	T-50	0.688	0.590	1.850	1.181	0.551	0.105
80459	T-55	0.750	0.750	1.850	1.181	0.551	0.158

3/8" OPEN STOCK

BIT SOCKETS

Torx® is a registered trademark of Acument Intellectual Properties, LLC.



External TORX® Sockets 3/8" DRIVE

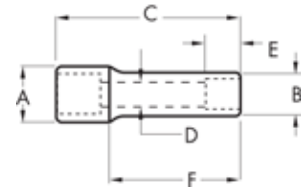

Item No.	Torx® Opening	Drive End (inch) A	Wrench End (inch) B	Overall Length (inch) C	Bolt Clearance D	Bolt Depth E	Length to Shoulder F	Weight (lbs)
80460	E-10	0.750	0.750	1.240	0.196	0.433	0.565	0.088
80461	E-12	0.750	0.750	1.240	0.314	0.433	0.565	0.092
80462	E-14	0.750	0.750	1.240	0.314	0.433	0.565	0.103
80463	E-16	0.750	0.750	1.240	0.314	0.433	0.565	0.114



**80481 - 5/16" Bit Holder Socket
Open Stock - Tamper-Proof Internal Torx® Bits**



Bit Holder works with the following insert bits:



Item No.	Bit Size	Bit Holder Size	Overall Length (inch) C	Bit Length (inch) D	Weight (lbs)
80477	T-40	5/16"	1.181	1.181	0.011
80478	T-45	5/16"	1.181	1.181	0.011
80479	T-50	5/16"	1.181	1.181	0.011



Long TORX® Bit Sockets 3/8" DRIVE

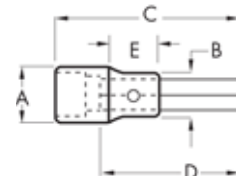

Item No.	Torx® Opening	Drive End (inch) A	Nose Dia. (inch) B	Overall Length (inch) C	Length to Shoulder F	Weight (lbs)
82517	T-40	0.688	0.590	5.984	0.551	0.198
82518	T-45	0.688	0.590	5.984	0.551	0.198
82519	T-50	0.688	0.590	5.984	0.551	0.200

Torx® is a registered trademark of Acument Intellectual Properties, LLC.

SCREWDRIVER Bit Sockets 3/8" DRIVE

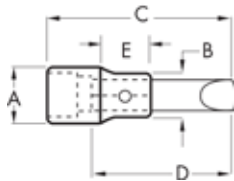

Item No.	Bit Size	Drive End (inch) A	Nose Dia. (inch) B	Overall Length (inch) C	Bit Length (inch) D	Length to Shoulder E	Weight (lbs)
80464	4 mm Slotted	0.688	0.590	1.653	0.984	0.551	0.096
80465	5 mm Slotted	0.688	0.590	1.653	0.984	0.551	0.096
80466	6 mm Slotted	0.688	0.590	1.653	0.984	0.551	0.096
80467	#1 Phillips	0.688	0.590	1.653	0.984	0.551	0.096
80468	#2 Phillips	0.688	0.590	1.653	0.984	0.551	0.096
80469	#3 Phillips	0.688	0.590	1.653	0.984	0.551	0.096
80470	#2 Pozidriv®	0.688	0.590	1.653	0.984	0.551	0.096

HEX Bit Sockets 1/2" DRIVE

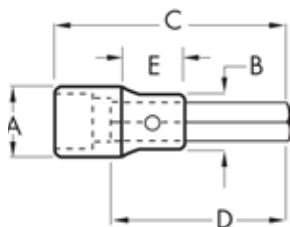

Item No.	Bit Size	Drive End (inch) A	Nose Dia. (inch) B	Overall Length (inch) C	Bit Length (inch) D	Length to Shoulder E	Weight (lbs)
80651	5/16"	0.944	0.665	2.480	1.490	0.787	0.206
80652	3/8"	0.944	0.700	2.480	1.490	0.787	0.233
80653	7/16"	0.944	0.748	2.480	1.490	0.787	0.244
80654	1/2"	0.944	0.944	2.480	1.490	0.000	0.277
80655	9/16"	1.023	1.023	2.480	1.490	0.000	0.334
80656	5/8"	1.023	1.023	2.480	1.490	0.000	0.343
80657	3/4"	1.102	1.102	2.480	1.490	0.000	0.437
80658	6 mm	0.944	0.665	2.480	1.490	0.787	0.204
80659	8 mm	0.944	0.665	2.480	1.490	0.787	0.206
80660	10 mm	0.944	0.748	2.480	1.490	0.787	0.237
80661	12 mm	0.944	0.944	2.480	1.490	0.000	0.290
80662	14 mm	1.023	1.023	2.480	1.490	0.000	0.352
80663	17 mm	1.102	1.102	2.480	1.490	0.000	0.426
80664	19 mm	1.102	1.102	2.480	1.490	0.000	0.437

1/2" OPEN STOCK

BIT SOCKETS

1/2" OPEN STOCK
BIT SOCKETS



TRIPLE SQUARE Bit Sockets 1/2" DRIVE

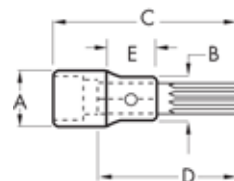

Item No.	Bit Size	Drive End (inch) A	Nose Dia. (inch) B	Overall Length (inch) C	Bit Length (inch) D	Length to Shoulder E	Weight (lbs)
80665	10 mm	0.944	0.748	4.210	3.180	0.7187	0.312
80666	12 mm	0.944	0.944	4.680	3.660	0.000	0.413



Torx® Press Fit Bit Sockets 1/2" DRIVE

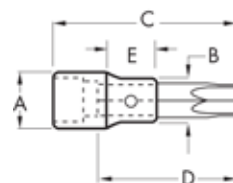

Item No.	Bit Size	Drive End (inch) A	Nose Dia. (inch) B	Overall Length (inch) C	Bit Length (inch) D	Length to Shoulder E	Weight (lbs)
80667	T-60	0.944	0.944	2.480	1.490	N/A	0.288

Torx® is a registered trademark of Acument Intellectual Properties, LLC.

Torx® Tamper-Proof Bit Sockets 1/2" DRIVE

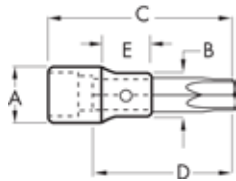

Item No.	Bit Size	Drive End (inch) A	Nose Dia. (inch) B	Overall Length (inch) C	Bit Length (inch) D	Length to Shoulder E	Weight (lbs)
80668	T-60	0.944	0.944	2.480	1.490	N/A	0.288

External Torx® Sockets 1/2" DRIVE

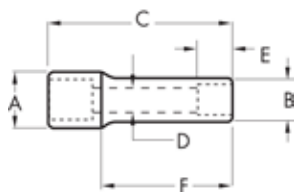

Item No.	Torx® Opening	Drive End (inch) A	Wrench End (inch) B	Overall Length (inch) C	Bolt Clearance D	Bolt Depth E	Length to Shoulder F	Weight (lbs)
80669	E-18	0.944	0.944	1.500	0.000	0.472	0.565	0.202
80670	E-20	0.944	0.944	1.750	0.000	0.472	0.565	0.222
80672	E-22	1.125	1.125	2.000	0.000	0.551	0.565	0.402
80673	E-24	1.125	1.125	2.000	0.000	0.551	0.565	0.391

Torx® is a registered trademark of Acument Intellectual Properties, LLC.



82401 - 5 Pc. SAE Flex Hex™ Key Set - Chrome

Item No.	Description
45053C	3/16" Satin Chrome Finish Flexible Hex Key
45054C	7/32" Satin Chrome Finish Flexible Hex Key
45055C	1/4" Satin Chrome Finish Flexible Hex Key
45056C	5/16" Satin Chrome Finish Flexible Hex Key
45057C	3/8" Satin Chrome Finish Flexible Hex Key



82411 - 6 Pc. METRIC Flex Hex™ Key Set - Chrome

Item No.	Description
45090C	3mm Satin Chrome Finish Flexible Hex Key
45091C	4mm Satin Chrome Finish Flexible Hex Key
45092C	5mm Satin Chrome Finish Flexible Hex Key
45093C	6mm Satin Chrome Finish Flexible Hex Key
45094C	8mm Satin Chrome Finish Flexible Hex Key
45095C	10mm Satin Chrome Finish Flexible Hex Key



82421 - 6 Pc. METRIC Flex Hex™ Key Set - Chrome

Item No.	Description
45080C	T-25 Satin Chrome Finish Flexible Torx® Key
45081C	T-27 Satin Chrome Finish Flexible Torx® Key
45082C	T-30 Satin Chrome Finish Flexible Torx® Key
45085C	T-40 Satin Chrome Finish Flexible Torx® Key
45087C	T-45 Satin Chrome Finish Flexible Torx® Key
45089C	T-50 Satin Chrome Finish Flexible Torx® Key

Torx® is a registered trademark of Acument Intellectual Properties, LLC.

SETS
FLEX HEX KEYS

Open Stock - Flex Hex™ Keys - Chrome



Item No.	Description	Weight (lbs)
45053C	3/16" Satin Chrome Finish Flexible Hex Key	0.040
45054C	7/32" Satin Chrome Finish Flexible Hex Key	0.073
45055C	1/4" Satin Chrome Finish Flexible Hex Key	0.123
45056C	5/16" Satin Chrome Finish Flexible Hex Key	0.249
45057C	3/8" Satin Chrome Finish Flexible Hex Key	0.438

Open Stock - Flex Hex™ Keys - Chrome



Item No.	Description	Key Size	Weight (lbs)
45080C	T-25 Satin Chrome Finish Flexible Torx® Key	T-25	0.057
45081C	T-27 Satin Chrome Finish Flexible Torx® Key	T-27	0.057
45082C	T-30 Satin Chrome Finish Flexible Torx® Key	T-30	0.057
45085C	T-40 Satin Chrome Finish Flexible Torx® Key	T-40	0.099
45087C	T-45 Satin Chrome Finish Flexible Torx® Key	T-45	0.202
45089C	T-50 Satin Chrome Finish Flexible Torx® Key	T-50	0.205

OPEN STOCK
FLEX HEX KEYS

Torx® is a registered trademark of Acument Intellectual Properties, LLC.

Open Stock - Flex Hex™ Keys - Chrome



Item No.	Description	Weight (lbs)
45090C	3mm Satin Chrome Finish Flexible Hex Key	0.020
45091C	4mm Satin Chrome Finish Flexible Hex Key	0.040
45092C	5mm Satin Chrome Finish Flexible Hex Key	0.073
45093C	6mm Satin Chrome Finish Flexible Hex Key	0.123
45094C	8mm Satin Chrome Finish Flexible Hex Key	0.249
45095C	10mm Satin Chrome Finish Flexible Hex Key	0.438

FLEX HEX KEYS OPEN STOCK

Torx® is a registered trademark of Acument Intellectual Properties, LLC.

IMPACT SOCKETS

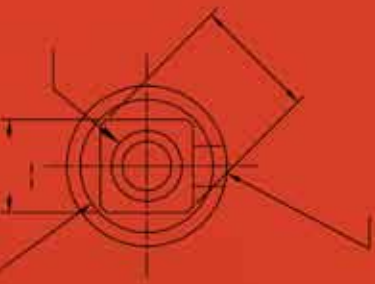

Impact Sockets

1/4" Drive Sets

1/4" Drive Open Stock

3/8" Drive Sets

3/8" Drive Open Stock

1/2" Drive Sets

1/2" Drive Open Stock

3/4" Drive Open Stock

IMPACT SOCKETS

AVAILABLE IN:

- 1/4" Drive
- 3/8" Drive
- 1/2" Drive
- 3/4" Drive
- Universal Sockets
- Hex Sockets
- Adapters and Drive Tools



Reinforced Molded cases with sizes marked for quick identification and storage

Reinforced Steel hinges for added durability

Steel Buckles provide security and strength

IMPACT SOCKETS

Surface Drive™ Technology



Chrome Molybdenum Alloy Steel (CR-MO) for exceptional strength and long lasting durability

High Visibility Laser Etched Markings

Additional Hard Stamping (on opposite side)



Pin hole available for use with pin and o-ring for secure socket retention



84903 - 71 Pc. Impact SAE/METRIC Standard, Deep & Universal Socket Set 1/4" DRIVE

Item No.	Description		
84100	3/16"	6 Pt. Std. Metric Socket	1/4" Dr.
84101	7/32"	6 Pt. Std. Metric Socket	1/4" Dr.
84102	1/4"	6 Pt. Std. Metric Socket	1/4" Dr.
84103	9/32"	6 Pt. Std. Metric Socket	1/4" Dr.
84104	5/16"	6 Pt. Std. Metric Socket	1/4" Dr.
84105	11/32"	6 Pt. Std. Metric Socket	1/4" Dr.
84106	3/8"	6 Pt. Std. Metric Socket	1/4" Dr.
84107	7/16"	6 Pt. Std. Metric Socket	1/4" Dr.
84108	1/2"	6 Pt. Std. Metric Socket	1/4" Dr.
84109	9/16"	6 Pt. Std. Metric Socket	1/4" Dr.
84111	4 mm	6 Pt. Std. Metric Socket	1/4" Dr.
84112	4.5 mm	6 Pt. Std. Metric Socket	1/4" Dr.
84113	5 mm	6 Pt. Std. Metric Socket	1/4" Dr.
84114	5.5 mm	6 Pt. Std. Metric Socket	1/4" Dr.
84115	6 mm	6 Pt. Std. Metric Socket	1/4" Dr.
84116	7 mm	6 Pt. Std. Metric Socket	1/4" Dr.
84117	8 mm	6 Pt. Std. Metric Socket	1/4" Dr.
84118	9 mm	6 Pt. Std. Metric Socket	1/4" Dr.
84119	10 mm	6 Pt. Std. Metric Socket	1/4" Dr.
84120	11 mm	6 Pt. Std. Metric Socket	1/4" Dr.
84121	12 mm	6 Pt. Std. Metric Socket	1/4" Dr.
84122	13 mm	6 Pt. Std. Metric Socket	1/4" Dr.
84123	14 mm	6 Pt. Std. Metric Socket	1/4" Dr.
84124	15 mm	6 Pt. Deep Metric Socket	1/4" Dr.
84126	3/16"	6 Pt. Deep Metric Socket	1/4" Dr.
84127	7/32"	6 Pt. Deep Metric Socket	1/4" Dr.
84128	1/4"	6 Pt. Deep Metric Socket	1/4" Dr.
84129	9/32"	6 Pt. Deep Metric Socket	1/4" Dr.
84130	5/16"	6 Pt. Deep Metric Socket	1/4" Dr.
84131	11/32"	6 Pt. Deep Metric Socket	1/4" Dr.

Item No.	Description		
84132	3/8"	6 Pt. Deep Metric Socket	1/4" Dr.
84133	7/16"	6 Pt. Deep Metric Socket	1/4" Dr.
84134	1/2"	6 Pt. Deep Metric Socket	1/4" Dr.
84135	9/16"	6 Pt. Deep Metric Socket	1/4" Dr.
84137	4 mm	6 Pt. Deep Metric Socket	1/4" Dr.
84138	4.5 mm	6 Pt. Deep Metric Socket	1/4" Dr.
84139	5 mm	6 Pt. Deep Metric Socket	1/4" Dr.
84140	5.5 mm	6 Pt. Deep Metric Socket	1/4" Dr.
84141	6 mm	6 Pt. Deep Metric Socket	1/4" Dr.
84142	7 mm	6 Pt. Deep Metric Socket	1/4" Dr.
84143	8 mm	6 Pt. Deep Metric Socket	1/4" Dr.
84144	9 mm	6 Pt. Deep Metric Socket	1/4" Dr.
84145	10 mm	6 Pt. Deep Metric Socket	1/4" Dr.
84146	11 mm	6 Pt. Deep Metric Socket	1/4" Dr.
84147	12 mm	6 Pt. Deep Metric Socket	1/4" Dr.
84148	13 mm	6 Pt. Deep Metric Socket	1/4" Dr.
84149	14 mm	6 Pt. Deep Metric Socket	1/4" Dr.
84150	15 mm	6 Pt. Deep Metric Socket	1/4" Dr.
84152	1/4"	6 Pt. Unv. SAE Socket	1/4" Dr.
84153	5/16"	6 Pt. Unv. SAE Socket	1/4" Dr.
84154	3/8"	6 Pt. Unv. SAE Socket	1/4" Dr.
84155	7/16"	6 Pt. Unv. Metric Socket	1/4" Dr.
84156	1/2"	6 Pt. Unv. Metric Socket	1/4" Dr.
84157	9/16"	6 Pt. Unv. Metric Socket	1/4" Dr.
84159	5 mm	6 Pt. Unv. Metric Socket	1/4" Dr.
84160	5.5 mm	6 Pt. Unv. Metric Socket	1/4" Dr.
84161	6 mm	6 Pt. Unv. Metric Socket	1/4" Dr.
84162	7 mm	6 Pt. Unv. Metric Socket	1/4" Dr.
84163	8 mm	6 Pt. Unv. Metric Socket	1/4" Dr.
84164	9 mm	6 Pt. Unv. Metric Socket	1/4" Dr.
84165	10 mm	6 Pt. Unv. Metric Socket	1/4" Dr.
84166	11 mm	6 Pt. Unv. Metric Socket	1/4" Dr.
84167	12 mm	6 Pt. Unv. Metric Socket	1/4" Dr.
84168	13 mm	6 Pt. Unv. Metric Socket	1/4" Dr.
84169	14 mm	6 Pt. Unv. Metric Socket	1/4" Dr.
84170	15 mm	6 Pt. Unv. Metric Socket	1/4" Dr.
84172	2" Extension		1/4" Dr.
84173	4" Extension		1/4" Dr.
84174	6" Extension		1/4" Dr.
80101	1/4" Unv. Joint		1/4" Dr.
84176	1/4" F x 3/8" M Adapter		1/4" Dr.

1/4" DRIVE SETS
IMPACT SOCKETS



84902 - 48 Pc. Impact SAE/METRIC Standard & Deep Socket Set 1/4" DRIVE

Item No.	Description	
84100	3/16"	6 Pt. Std. SAE Socket 1/4" Dr.
84101	7/32"	6 Pt. Std. SAE Socket 1/4" Dr.
84102	1/4"	6 Pt. Std. SAE Socket 1/4" Dr.
84103	9/32"	6 Pt. Std. SAE Socket 1/4" Dr.
84104	5/16"	6 Pt. Std. SAE Socket 1/4" Dr.
84105	11/32"	6 Pt. Std. SAE Socket 1/4" Dr.
84106	3/8"	6 Pt. Std. SAE Socket 1/4" Dr.
84107	7/16"	6 Pt. Std. SAE Socket 1/4" Dr.
84108	1/2"	6 Pt. Std. SAE Socket 1/4" Dr.
84109	9/16"	6 Pt. Std. SAE Socket 1/4" Dr.
84111	4 mm	6 Pt. Std. Metric Socket 1/4" Dr.
84112	4.5 mm	6 Pt. Std. Metric Socket 1/4" Dr.
84113	5 mm	6 Pt. Std. Metric Socket 1/4" Dr.
84114	5.5 mm	6 Pt. Std. Metric Socket 1/4" Dr.
84115	6 mm	6 Pt. Std. Metric Socket 1/4" Dr.
84116	7 mm	6 Pt. Std. Metric Socket 1/4" Dr.
84117	8 mm	6 Pt. Std. Metric Socket 1/4" Dr.
84118	9 mm	6 Pt. Std. Metric Socket 1/4" Dr.
84119	10 mm	6 Pt. Std. Metric Socket 1/4" Dr.
84120	11 mm	6 Pt. Std. Metric Socket 1/4" Dr.

Item No.	Description	
84121	12 mm	6 Pt. Std. Metric Socket 1/4" Dr.
84122	13 mm	6 Pt. Std. Metric Socket 1/4" Dr.
84123	14 mm	6 Pt. Deep Metric Socket 1/4" Dr.
84124	15 mm	6 Pt. Deep Metric Socket 1/4" Dr.
84126	3/16"	6 Pt. Deep SAE Socket 1/4" Dr.
84127	7/32"	6 Pt. Deep SAE Socket 1/4" Dr.
84128	1/4"	6 Pt. Deep SAE Socket 1/4" Dr.
84129	9/32"	6 Pt. Deep SAE Socket 1/4" Dr.
84130	5/16"	6 Pt. Deep SAE Socket 1/4" Dr.
84131	11/32"	6 Pt. Deep SAE Socket 1/4" Dr.
84132	3/8"	6 Pt. Deep SAE Socket 1/4" Dr.
84133	7/16"	6 Pt. Deep SAE Socket 1/4" Dr.
84134	1/2"	6 Pt. Deep SAE Socket 1/4" Dr.
84135	9/16"	6 Pt. Deep SAE Socket 1/4" Dr.
84137	4 mm	6 Pt. Deep Metric Socket 1/4" Dr.
84138	4.5 mm	6 Pt. Deep Metric Socket 1/4" Dr.
84139	5 mm	6 Pt. Deep Metric Socket 1/4" Dr.
84140	5.5 mm	6 Pt. Deep Metric Socket 1/4" Dr.
84141	6 mm	6 Pt. Deep Metric Socket 1/4" Dr.
84142	7 mm	6 Pt. Deep Metric Socket 1/4" Dr.
84143	8 mm	6 Pt. Deep Metric Socket 1/4" Dr.
84144	9 mm	6 Pt. Deep Metric Socket 1/4" Dr.
84145	10 mm	6 Pt. Deep Metric Socket 1/4" Dr.
84146	11 mm	6 Pt. Deep Metric Socket 1/4" Dr.
84147	12 mm	6 Pt. Deep Metric Socket 1/4" Dr.
84148	13 mm	6 Pt. Deep Metric Socket 1/4" Dr.
84149	14 mm	6 Pt. Deep Metric Socket 1/4" Dr.
84150	15 mm	6 Pt. Deep Metric Socket 1/4" Dr.

IMPACT SOCKETS 1/4" DRIVE SETS

84900 - 20 Pc. Impact SAE Standard & Deep Socket Set 1/4" DRIVE

Item No.	Description			
84100	3/16"	6 Pt. Std. SAE Socket	1/4" Dr.	
84101	7/32"	6 Pt. Std. SAE Socket	1/4" Dr.	
84102	1/4"	6 Pt. Std. SAE Socket	1/4" Dr.	
84103	9/32"	6 Pt. Std. SAE Socket	1/4" Dr.	
84104	5/16"	6 Pt. Std. SAE Socket	1/4" Dr.	
84105	11/32"	6 Pt. Std. SAE Socket	1/4" Dr.	
84106	3/8"	6 Pt. Std. SAE Socket	1/4" Dr.	
84107	7/16"	6 Pt. Std. SAE Socket	1/4" Dr.	
84108	1/2"	6 Pt. Std. SAE Socket	1/4" Dr.	
84109	9/16"	6 Pt. Std. SAE Socket	1/4" Dr.	
84126	3/16"	6 Pt. Deep SAE Socket	1/4" Dr.	
84127	7/32"	6 Pt. Deep SAE Socket	1/4" Dr.	
84128	1/4"	6 Pt. Deep SAE Socket	1/4" Dr.	
84129	9/32"	6 Pt. Deep SAE Socket	1/4" Dr.	
84130	5/16"	6 Pt. Deep SAE Socket	1/4" Dr.	



Item No.	Description			
84131	11/32"	6 Pt. Deep SAE Socket	1/4" Dr.	
84132	3/8"	6 Pt. Deep SAE Socket	1/4" Dr.	
84133	7/16"	6 Pt. Deep SAE Socket	1/4" Dr.	
84134	1/2"	6 Pt. Deep SAE Socket	1/4" Dr.	
84135	9/16"	6 Pt. Deep SAE Socket	1/4" Dr.	

84901 - 28 Pc. Impact METRIC Standard & Deep Socket Set 1/4" DRIVE

Item No.	Description			
84111	4 mm	6 Pt. Std. Metric Socket	1/4" Dr.	
84112	4.5 mm	6 Pt. Std. Metric Socket	1/4" Dr.	
84113	5 mm	6 Pt. Std. Metric Socket	1/4" Dr.	
84114	5.5 mm	6 Pt. Std. Metric Socket	1/4" Dr.	
84115	6 mm	6 Pt. Std. Metric Socket	1/4" Dr.	
84116	7 mm	6 Pt. Std. Metric Socket	1/4" Dr.	
84117	8 mm	6 Pt. Std. Metric Socket	1/4" Dr.	
84118	9 mm	6 Pt. Std. Metric Socket	1/4" Dr.	
84119	10 mm	6 Pt. Std. Metric Socket	1/4" Dr.	
84120	11 mm	6 Pt. Std. Metric Socket	1/4" Dr.	
84121	12 mm	6 Pt. Std. Metric Socket	1/4" Dr.	
84122	13 mm	6 Pt. Std. Metric Socket	1/4" Dr.	
84123	14 mm	6 Pt. Std. Metric Socket	1/4" Dr.	
84124	15 mm	6 Pt. Deep Metric Socket	1/4" Dr.	
84137	4 mm	6 Pt. Deep Metric Socket	1/4" Dr.	
84138	4.5 mm	6 Pt. Deep Metric Socket	1/4" Dr.	
84139	5 mm	6 Pt. Deep Metric Socket	1/4" Dr.	
84140	5.5 mm	6 Pt. Deep Metric Socket	1/4" Dr.	
84141	6 mm	6 Pt. Deep Metric Socket	1/4" Dr.	



Item No.	Description			
84142	7 mm	6 Pt. Deep Metric Socket	1/4" Dr.	
84143	8 mm	6 Pt. Deep Metric Socket	1/4" Dr.	
84144	9 mm	6 Pt. Deep Metric Socket	1/4" Dr.	
84145	10 mm	6 Pt. Deep Metric Socket	1/4" Dr.	
84146	11 mm	6 Pt. Deep Metric Socket	1/4" Dr.	
84147	12 mm	6 Pt. Deep Metric Socket	1/4" Dr.	
84148	13 mm	6 Pt. Deep Metric Socket	1/4" Dr.	
84149	14 mm	6 Pt. Deep Metric Socket	1/4" Dr.	
84150	15 mm	6 Pt. Deep Metric Socket	1/4" Dr.	



**84906 - 10 Pc. Impact SAE Standard Socket Set
1/4" DRIVE**

Item No.	Description
84107	7/16" 6 Pt. Std. SAE Socket 1/4" Dr.
84108	1/2" 6 Pt. Std. SAE Socket 1/4" Dr.
84109	9/16" 6 Pt. Std. SAE Socket 1/4" Dr.

Item No.	Description
84100	3/16" 6 Pt. Std. SAE Socket 1/4" Dr.
84101	7/32" 6 Pt. Std. SAE Socket 1/4" Dr.
84102	1/4" 6 Pt. Std. SAE Socket 1/4" Dr.
84103	9/32" 6 Pt. Std. SAE Socket 1/4" Dr.
84104	5/16" 6 Pt. Std. SAE Socket 1/4" Dr.
84105	11/32" 6 Pt. Std. SAE Socket 1/4" Dr.
84106	3/8" 6 Pt. Std. SAE Socket 1/4" Dr.



**84907 - 14 Pc. Impact METRIC Standard & Deep Socket Set
1/4" DRIVE**

Item No.	Description
84120	11 mm 6 Pt. Std. Metric Socket 1/4" Dr.
84121	12 mm 6 Pt. Std. Metric Socket 1/4" Dr.
84122	13 mm 6 Pt. Std. Metric Socket 1/4" Dr.
84123	14 mm 6 Pt. Std. Metric Socket 1/4" Dr.
84124	15 mm 6 Pt. Std. Metric Socket 1/4" Dr.

Item No.	Description
84111	4 mm 6 Pt. Std. Metric Socket 1/4" Dr.
84112	4.5 mm 6 Pt. Std. Metric Socket 1/4" Dr.
84113	5 mm 6 Pt. Std. Metric Socket 1/4" Dr.
84114	5.5 mm 6 Pt. Std. Metric Socket 1/4" Dr.
84115	6 mm 6 Pt. Std. Metric Socket 1/4" Dr.
84116	7 mm 6 Pt. Std. Metric Socket 1/4" Dr.
84117	8 mm 6 Pt. Std. Metric Socket 1/4" Dr.
84118	9 mm 6 Pt. Std. Metric Socket 1/4" Dr.
84119	10 mm 6 Pt. Std. Metric Socket 1/4" Dr.



**84908 - 10 Pc. Impact SAE Deep Socket Set
1/4" DRIVE**

Item No.	Description
84133	7/16" 6 Pt. Deep SAE Socket 1/4" Dr.
84134	1/2" 6 Pt. Deep SAE Socket 1/4" Dr.
84135	9/16" 6 Pt. Deep SAE Socket 1/4" Dr.

Item No.	Description
84126	3/16" 6 Pt. Deep SAE Socket 1/4" Dr.
84127	7/32" 6 Pt. Deep SAE Socket 1/4" Dr.
84128	1/4" 6 Pt. Deep SAE Socket 1/4" Dr.
84129	9/32" 6 Pt. Deep SAE Socket 1/4" Dr.
84130	5/16" 6 Pt. Deep SAE Socket 1/4" Dr.
84131	11/32" 6 Pt. Deep SAE Socket 1/4" Dr.
84132	3/8" 6 Pt. Deep SAE Socket 1/4" Dr.

IMPACT SOCKETS 1/4" DRIVE SETS

**84909 - 14 Pc. Impact METRIC Deep Socket Set
1/4" DRIVE**

Item No.	Description		
84137	4 mm	6 Pt. Deep Metric Socket	1/4" Dr.
84138	4.5 mm	6 Pt. Deep Metric Socket	1/4" Dr.
84139	5 mm	6 Pt. Deep Metric Socket	1/4" Dr.
84140	5.5 mm	6 Pt. Deep Metric Socket	1/4" Dr.
84141	6 mm	6 Pt. Deep Metric Socket	1/4" Dr.
84142	7 mm	6 Pt. Deep Metric Socket	1/4" Dr.
84143	8 mm	6 Pt. Deep Metric Socket	1/4" Dr.
84144	9 mm	6 Pt. Deep Metric Socket	1/4" Dr.
84145	10 mm	6 Pt. Deep Metric Socket	1/4" Dr.



84146	11 mm	6 Pt. Deep Metric Socket	1/4" Dr.
84147	12 mm	6 Pt. Deep Metric Socket	1/4" Dr.
84148	13 mm	6 Pt. Deep Metric Socket	1/4" Dr.
84149	14 mm	6 Pt. Deep Metric Socket	1/4" Dr.
84150	15 mm	6 Pt. Deep Metric Socket	1/4" Dr.

**84904 - 6 Pc. Impact SAE Universal Socket Set
1/4" DRIVE**

Item No.	Description		
84152	1/4"	6 Pt. Universal SAE Socket	1/4" Dr.
84153	5/16"	6 Pt. Universal SAE Socket	1/4" Dr.
84154	3/8"	6 Pt. Universal SAE Socket	1/4" Dr.
84155	7/16"	6 Pt. Universal SAE Socket	1/4" Dr.



Item No.	Description		
84156	1/2"	6 Pt. Universal SAE Socket	1/4" Dr.
84157	9/16"	6 Pt. Universal SAE Socket	1/4" Dr.

**84905 - 12 Pc. Impact METRIC Universal Socket Set
1/4" DRIVE**

Item No.	Description		
84159	5 mm	6 Pt. Universal Metric Socket	1/4" Dr.
84160	5.5 mm	6 Pt. Universal Metric Socket	1/4" Dr.
84161	6 mm	6 Pt. Universal Metric Socket	1/4" Dr.
84162	7 mm	6 Pt. Universal Metric Socket	1/4" Dr.
84163	8 mm	6 Pt. Universal Metric Socket	1/4" Dr.
84164	9 mm	6 Pt. Universal Metric Socket	1/4" Dr.
84165	10 mm	6 Pt. Universal Metric Socket	1/4" Dr.
84166	11 mm	6 Pt. Universal Metric Socket	1/4" Dr.



Item No.	Description		
84167	12 mm	6 Pt. Universal Metric Socket	1/4" Dr.
84168	13 mm	6 Pt. Universal Metric Socket	1/4" Dr.
84169	14 mm	6 Pt. Universal Metric Socket	1/4" Dr.
84170	15 mm	6 Pt. Universal Metric Socket	1/4" Dr.

Impact Extension Bars SAE 1/4" DRIVE

Item No.	Description	Weight (lbs)
84172	2" Extension Bar	0.066
84173	4" Extension Bar	0.132
84174	6" Extension Bar	0.172





Standard Impact Adapters SAE 1/4" DRIVE

Item No.	Description	Weight (lbs)
84176	1/4" F x 3/8" M Impact Adapter	0.04



Universal Impact Joints SAE 1/4" DRIVE

Item No.	Description	Weight (lbs)
80101	1/4" Universal Joints	0.095



6 Pt. Standard Impact Sockets SAE/METRIC 1/4" DRIVE

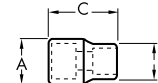

Item No.	Size	Description	Drive End (inch) A	Wrench End (inch) B	Overall Length (inch) C	Weight (lbs)
84100	3/16"	6 Pt. Std. SAE	0.512	0.335	0.906	0.026
84101	7/32"	6 Pt. Std. SAE	0.512	0.374	0.906	0.026
84102	1/4"	6 Pt. Std. SAE	0.512	0.406	0.906	0.026
84103	9/32"	6 Pt. Std. SAE	0.512	0.445	0.906	0.026
84104	5/16"	6 Pt. Std. SAE	0.512	0.492	0.906	0.031
84105	11/32"	6 Pt. Std. SAE	0.512	0.543	0.906	0.037
84106	3/8"	6 Pt. Std. SAE	0.512	0.591	0.906	0.037
84107	7/16"	6 Pt. Std. SAE	0.512	0.642	0.906	0.066
84108	1/2"	6 Pt. Std. SAE	0.512	0.74	0.906	0.066
84109	9/16"	6 Pt. Std. SAE	0.512	0.74	0.906	0.066
84111	4 mm	6 Pt. Std. Metric	0.512	0.335	0.906	0.026
84112	4.5 mm	6 Pt. Std. Metric	0.512	0.335	0.906	0.026
84113	5 mm	6 Pt. Std. Metric	0.512	0.346	0.906	0.026
84114	5.5 mm	6 Pt. Std. Metric	0.512	0.374	0.906	0.026
84115	6 mm	6 Pt. Std. Metric	0.512	0.394	0.906	0.026
84116	7 mm	6 Pt. Std. Metric	0.512	0.445	0.906	0.029
84117	8 mm	6 Pt. Std. Metric	0.512	0.492	0.906	0.031
84118	9 mm	6 Pt. Std. Metric	0.512	0.543	0.906	0.037
84119	10 mm	6 Pt. Std. Metric	0.512	0.591	0.906	0.042
84120	11 mm	6 Pt. Std. Metric	0.512	0.642	0.906	0.049
84121	12 mm	6 Pt. Std. Metric	0.512	0.669	0.906	0.057
84122	13 mm	6 Pt. Std. Metric	0.512	0.74	0.906	0.068
84123	14 mm	6 Pt. Std. Metric	0.512	0.787	0.906	0.084
84124	15 mm	6 Pt. Std. Metric	0.512	0.827	0.906	0.095

IMPACT SOCKETS 1/4" OPEN STOCK

6 Pt. Deep Impact Sockets SAE/METRIC 1/4" DRIVE

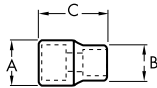

Item No.	Size	Description	Drive End	Wrench End	Overall	Weight
			(inch) A	(inch) B	Length (inch) C	
84126	3/16"	6 Pt. Deep SAE	0.512	0.335	1.968	0.053
84127	7/32"	6 Pt. Deep SAE	0.512	0.374	1.968	0.053
84128	1/4"	6 Pt. Deep SAE	0.512	0.406	1.968	0.053
84129	9/32"	6 Pt. Deep SAE	0.512	0.445	1.968	0.053
84130	5/16"	6 Pt. Deep SAE	0.512	0.492	1.968	0.053
84131	11/32"	6 Pt. Deep SAE	0.512	0.543	1.968	0.066
84132	3/8"	6 Pt. Deep SAE	0.512	0.591	1.968	0.093
84133	7/16"	6 Pt. Deep SAE	0.512	0.642	1.968	0.132
84134	1/2"	6 Pt. Deep SAE	0.512	0.74	1.968	0.132
84135	9/16"	6 Pt. Deep SAE	0.512	0.787	1.968	0.132
84137	4 mm	6 Pt. Deep Metric	0.512	0.335	1.968	0.053
84138	4.5 mm	6 Pt. Deep Metric	0.512	0.335	1.968	0.053
84139	5 mm	6 Pt. Deep Metric	0.512	0.335	1.968	0.053
84140	5.5 mm	6 Pt. Deep Metric	0.512	0.374	1.968	0.053
84141	6 mm	6 Pt. Deep Metric	0.512	0.394	1.968	0.053
84142	7 mm	6 Pt. Deep Metric	0.512	0.445	1.968	0.053
84143	8 mm	6 Pt. Deep Metric	0.512	0.492	1.968	0.053
84144	9 mm	6 Pt. Deep Metric	0.512	0.543	1.968	0.066
84145	10 mm	6 Pt. Deep Metric	0.512	0.591	1.968	0.093
84146	11 mm	6 Pt. Deep Metric	0.512	0.642	1.968	0.132
84147	12 mm	6 Pt. Deep Metric	0.512	0.669	1.968	0.132
84148	13 mm	6 Pt. Deep Metric	0.512	0.74	1.968	0.132
84149	14 mm	6 Pt. Deep Metric	0.512	0.787	1.968	0.132
84150	15 mm	6 Pt. Deep Metric	0.512	0.827	1.968	0.132

1/4" OPEN STOCK
IMPACT SOCKETS



6 Pt. Universal Impact Sockets SAE/METRIC 1/4" DRIVE

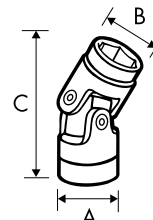

Item No.	Size	Description	Drive End (inch) A	Wrench End (inch) B	Overall Length (inch) C	Weight (lbs)
84152	1/4"	6 Pt. Unv. SAE	0.787	0.406	1.831	0.095
84153	5/16"	6 Pt. Unv. SAE	0.787	0.492	1.831	0.093
84154	3/8"	6 Pt. Unv. SAE	0.787	0.591	1.831	0.110
84156	1/2"	6 Pt. Unv. SAE	0.787	0.591	1.831	0.115
84157	9/16"	6 Pt. Unv. SAE	0.787	0.591	1.831	0.120
84159	5 mm	6 Pt. Unv. Metric	0.787	0.374	1.831	0.088
84160	5.5 mm	6 Pt. Unv. Metric	0.787	0.374	1.831	0.088
84161	6 mm	6 Pt. Unv. Metric	0.787	0.394	1.831	0.088
84162	7 mm	6 Pt. Unv. Metric	0.787	0.453	1.831	0.095
84163	8 mm	6 Pt. Unv. Metric	0.787	0.492	1.831	0.095
84164	9 mm	6 Pt. Unv. Metric	0.787	0.551	1.831	0.093
84165	10 mm	6 Pt. Unv. Metric	0.787	0.591	1.831	0.104
84166	11 mm	6 Pt. Unv. Metric	0.787	0.65	1.831	0.115
84167	12 mm	6 Pt. Unv. Metric	0.787	0.661	1.831	0.115
84168	13 mm	6 Pt. Unv. Metric	0.787	0.74	1.831	0.123
84169	14 mm	6 Pt. Unv. Metric	0.787	0.78	1.831	0.132
84170	15 mm	6 Pt. Unv. Metric	0.787	0.819	1.831	0.141

IMPACT SOCKETS 1/4" OPEN STOCK

84916 - 44 Pc. Impact SAE/METRIC Standard & Deep Socket Set 3/8" DRIVE

Item No.	Description		
84300	5/16"	6 Pt. Std. SAE Socket	3/8" Dr.
84301	3/8"	6 Pt. Std. SAE Socket	3/8" Dr.
84302	7/16"	6 Pt. Std. SAE Socket	3/8" Dr.
84303	1/2"	6 Pt. Std. SAE Socket	3/8" Dr.
84304	9/16"	6 Pt. Std. SAE Socket	3/8" Dr.
84305	5/8"	6 Pt. Std. SAE Socket	3/8" Dr.
84306	11/16"	6 Pt. Std. SAE Socket	3/8" Dr.
84307	3/4"	6 Pt. Std. SAE Socket	3/8" Dr.
84309	8 mm	6 Pt. Std. Metric Socket	3/8" Dr.
84310	9 mm	6 Pt. Std. Metric Socket	3/8" Dr.
84311	10 mm	6 Pt. Std. Metric Socket	3/8" Dr.
84312	11 mm	6 Pt. Std. Metric Socket	3/8" Dr.
84313	12 mm	6 Pt. Std. Metric Socket	3/8" Dr.
84314	13 mm	6 Pt. Std. Metric Socket	3/8" Dr.
84315	14 mm	6 Pt. Std. Metric Socket	3/8" Dr.
84316	15 mm	6 Pt. Std. Metric Socket	3/8" Dr.
84317	16 mm	6 Pt. Std. Metric Socket	3/8" Dr.
84318	17 mm	6 Pt. Std. Metric Socket	3/8" Dr.
84319	18 mm	6 Pt. Std. Metric Socket	3/8" Dr.
84320	19 mm	6 Pt. Std. Metric Socket	3/8" Dr.
84322	5/16"	6 Pt. Deep SAE Socket	3/8" Dr.
84323	3/8"	6 Pt. Deep SAE Socket	3/8" Dr.
84324	7/16"	6 Pt. Deep SAE Socket	3/8" Dr.
84325	1/2"	6 Pt. Deep SAE Socket	3/8" Dr.
84326	9/16"	6 Pt. Deep SAE Socket	3/8" Dr.
84327	5/8"	6 Pt. Deep SAE Socket	3/8" Dr.
84328	11/16"	6 Pt. Deep SAE Socket	3/8" Dr.
84329	3/4"	6 Pt. Deep SAE Socket	3/8" Dr.



Item No.	Description		
84331	8 mm	6 Pt. Deep Metric Socket	3/8" Dr.
84332	9 mm	6 Pt. Deep Metric Socket	3/8" Dr.
84333	10 mm	6 Pt. Deep Metric Socket	3/8" Dr.
84334	11 mm	6 Pt. Deep Metric Socket	3/8" Dr.
84335	12 mm	6 Pt. Deep Metric Socket	3/8" Dr.
84336	13 mm	6 Pt. Deep Metric Socket	3/8" Dr.
84337	14 mm	6 Pt. Deep Metric Socket	3/8" Dr.
84338	15 mm	6 Pt. Deep Metric Socket	3/8" Dr.
84339	16 mm	6 Pt. Deep Metric Socket	3/8" Dr.
84340	17 mm	6 Pt. Deep Metric Socket	3/8" Dr.
84341	18 mm	6 Pt. Deep Metric Socket	3/8" Dr.
84342	19 mm	6 Pt. Deep Metric Socket	3/8" Dr.
84343	21 mm	6 Pt. Deep Metric Socket	3/8" Dr.
84406	3' Extension		3/8" Dr.
84407	6' Extension		3/8" Dr.
84405	10' Extension		3/8" Dr.

3/8" DRIVE SETS

IMPACT SOCKETS



**84910 - 8 Pc. Impact SAE Standard Socket Set
3/8" DRIVE**

Item No.	Description		
84300	5/16"	6 Pt. Std. SAE Socket	3/8" Dr.
84301	3/8"	6 Pt. Std. SAE Socket	3/8" Dr.
84302	7/16"	6 Pt. Std. SAE Socket	3/8" Dr.
84303	1/2"	6 Pt. Std. SAE Socket	3/8" Dr.
84304	9/16"	6 Pt. Std. SAE Socket	3/8" Dr.
84305	5/8"	6 Pt. Std. SAE Socket	3/8" Dr.
84306	11/16"	6 Pt. Std. SAE Socket	3/8" Dr.
84307	3/4"	6 Pt. Std. SAE Socket	3/8" Dr.



**84911 - 12 Pc. Impact METRIC Standard Socket Set
3/8" DRIVE**

Item No.	Description		
84309	8 mm	6 Pt. Std. Metric Socket	3/8" Dr.
84310	9 mm	6 Pt. Std. Metric Socket	3/8" Dr.
84311	10 mm	6 Pt. Std. Metric Socket	3/8" Dr.
84312	11 mm	6 Pt. Std. Metric Socket	3/8" Dr.
84313	12 mm	6 Pt. Std. Metric Socket	3/8" Dr.
84314	13 mm	6 Pt. Std. Metric Socket	3/8" Dr.
84315	14 mm	6 Pt. Std. Metric Socket	3/8" Dr.
84316	15 mm	6 Pt. Std. Metric Socket	3/8" Dr.
84317	16 mm	6 Pt. Std. Metric Socket	3/8" Dr.
84318	17 mm	6 Pt. Std. Metric Socket	3/8" Dr.
84319	18 mm	6 Pt. Std. Metric Socket	3/8" Dr.
84320	19 mm	6 Pt. Std. Metric Socket	3/8" Dr.



**84915 - 8 Pc. Impact SAE Deep Socket Set
3/8" DRIVE**

Item No.	Description		
84322	5/16"	6 Pt. Deep SAE Socket	3/8" Dr.
84323	3/8"	6 Pt. Deep SAE Socket	3/8" Dr.
84324	7/16"	6 Pt. Deep SAE Socket	3/8" Dr.
84325	1/2"	6 Pt. Deep SAE Socket	3/8" Dr.
84326	9/16"	6 Pt. Deep SAE Socket	3/8" Dr.
84327	5/8"	6 Pt. Deep SAE Socket	3/8" Dr.
84328	11/16"	6 Pt. Deep SAE Socket	3/8" Dr.
84329	3/4"	6 Pt. Deep SAE Socket	3/8" Dr.

IMPACT SOCKETS 3/8" DRIVE SETS

**84914 - 13 Pc. Impact METRIC Deep Socket Set
3/8" DRIVE**

Item No.	Description		
84331	8 mm	6 Pt. Deep Metric Socket	3/8" Dr.
84332	9 mm	6 Pt. Deep Metric Socket	3/8" Dr.
84333	10 mm	6 Pt. Deep Metric Socket	3/8" Dr.
84334	11 mm	6 Pt. Deep Metric Socket	3/8" Dr.
84335	12 mm	6 Pt. Deep Metric Socket	3/8" Dr.
84336	13 mm	6 Pt. Deep Metric Socket	3/8" Dr.
84337	14 mm	6 Pt. Deep Metric Socket	3/8" Dr.
84338	15 mm	6 Pt. Deep Metric Socket	3/8" Dr.
84339	16 mm	6 Pt. Deep Metric Socket	3/8" Dr.
84340	17 mm	6 Pt. Deep Metric Socket	3/8" Dr.
84341	18 mm	6 Pt. Deep Metric Socket	3/8" Dr.
84342	19 mm	6 Pt. Deep Metric Socket	3/8" Dr.
84343	21 mm	6 Pt. Deep Metric Socket	3/8" Dr.



**84913 - 7 Pc. Impact SAE HEX Socket Set
3/8" DRIVE**

Item No.	Description		
84397	3/16"	6 Pt. Hex Bit SAE Socket	3/8" Dr.
84398	7/16"	6 Pt. Hex Bit SAE Socket	3/8" Dr.
84399	1/4"	6 Pt. Hex Bit SAE Socket	3/8" Dr.
84400	5/16"	6 Pt. Hex Bit SAE Socket	3/8" Dr.
84401	3/8"	6 Pt. Hex Bit SAE Socket	3/8" Dr.
84402	7/16"	6 Pt. Hex Bit SAE Socket	3/8" Dr.
84403	1/2"	6 Pt. Hex Bit SAE Socket	3/8" Dr.



**84912 - 7 Pc. Impact METRIC HEX Socket Set
3/8" DRIVE**

Item No.	Description		
84389	4 mm	6 Pt. Hex Bit Metric Socket	3/8" Dr.
84390	5 mm	6 Pt. Hex Bit Metric Socket	3/8" Dr.
84391	6 mm	6 Pt. Hex Bit Metric Socket	3/8" Dr.
84392	7 mm	6 Pt. Hex Bit Metric Socket	3/8" Dr.
84393	8 mm	6 Pt. Hex Bit Metric Socket	3/8" Dr.
84394	10 mm	6 Pt. Hex Bit SAE Socket	3/8" Dr.
84395	12 mm	6 Pt. Hex Bit SAE Socket	3/8" Dr.





**84917 - 8 Pc. Impact SAE Universal Socket Set
3/8" DRIVE**

Item No.	Description		
84345	5/8"	6 Pt. Unv. SAE Socket	3/8" Dr.
84346	3/8"	6 Pt. Unv. SAE Socket	3/8" Dr.
84347	7/16"	6 Pt. Unv. SAE Socket	3/8" Dr.
84348	1/2"	6 Pt. Unv. SAE Socket	3/8" Dr.
84349	9/16"	6 Pt. Unv. SAE Socket	3/8" Dr.
84350	5/8"	6 Pt. Unv. SAE Socket	3/8" Dr.
84351	11/16"	6 Pt. Unv. SAE Socket	3/8" Dr.
84352	3/4"	6 Pt. Unv. SAE Socket	3/8" Dr.



**84918 - 15 Pc. Impact METRIC Universal Socket Set
3/8" DRIVE**

Item No.	Description		
84354	8 mm	6 Pt. Unv. Metric Socket	3/8" Dr.
84355	9 mm	6 Pt. Unv. Metric Socket	3/8" Dr.
84356	10 mm	6 Pt. Unv. Metric Socket	3/8" Dr.
84357	11 mm	6 Pt. Unv. Metric Socket	3/8" Dr.
84358	12 mm	6 Pt. Unv. Metric Socket	3/8" Dr.
84359	13 mm	6 Pt. Unv. Metric Socket	3/8" Dr.
84360	14 mm	6 Pt. Unv. Metric Socket	3/8" Dr.
84361	15 mm	6 Pt. Unv. Metric Socket	3/8" Dr.
84362	16 mm	6 Pt. Unv. Metric Socket	3/8" Dr.
84363	17 mm	6 Pt. Unv. Metric Socket	3/8" Dr.
84364	18 mm	6 Pt. Unv. Metric Socket	3/8" Dr.
84365	19 mm	6 Pt. Unv. Metric Socket	3/8" Dr.
84366	20 mm	6 Pt. Unv. Metric Socket	3/8" Dr.
84367	21 mm	6 Pt. Unv. Metric Socket	3/8" Dr.
84368	22 mm	6 Pt. Unv. Metric Socket	3/8" Dr.



Impact Extension Bars SAE 3/8" DRIVE

Item No.	Description	Weight (lbs)
84406	3" Extension Bar	0.176
84407	6" Extension Bar	0.353
84405	10" Extension Bar	0.551



Standard Impact Adapters SAE 3/8" DRIVE

Item No.	Description	Weight (lbs)
84408	3/8" F x 1/2" M Impact Adapter	0.117

IMPACT SOCKETS 3/8" DRIVE SETS

Universal Impact Joints SAE 3/8" DRIVE

Item No.	Description	Weight (lbs)
80548	3/8" Universal Joint	0.243



6 Pt. Standard Impact Sockets SAE/METRIC 3/8" DRIVE

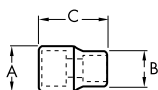

Item No.	Size	Description	Drive End (inch) A	Wrench End (inch) B	Overall Length (inch) C	Weight (lbs)
84300	5/16"	6 Pt. Std. SAE	0.748	0.496	1.161	0.071
84301	3/8"	6 Pt. Std. SAE	0.748	0.575	1.161	0.075
84302	7/16"	6 Pt. Std. SAE	0.748	0.669	1.161	0.079
84303	1/2"	6 Pt. Std. SAE	0.787	0.787	1.161	0.095
84304	9/16"	6 Pt. Std. SAE	0.827	0.827	1.161	0.106
84305	5/8"	6 Pt. Std. SAE	0.906	0.906	1.181	0.132
84306	11/16"	6 Pt. Std. SAE	0.945	0.945	1.181	0.139
84307	3/4"	6 Pt. Std. SAE	1.024	1.024	1.181	0.157
84309	8 mm	6 Pt. Std. Metric	0.748	0.5	1.161	0.071
84310	9 mm	6 Pt. Std. Metric	0.748	0.551	1.161	0.075
84311	10 mm	6 Pt. Std. Metric	0.748	0.598	1.161	0.075
84312	11 mm	6 Pt. Std. Metric	0.748	0.669	1.161	0.079
84313	12 mm	6 Pt. Std. Metric	0.748	0.748	1.161	0.088
84314	13 mm	6 Pt. Std. Metric	0.787	0.787	1.161	0.095
84315	14 mm	6 Pt. Std. Metric	0.827	0.827	1.161	0.11
84316	15 mm	6 Pt. Std. Metric	0.866	0.866	1.161	0.121
84317	16 mm	6 Pt. Std. Metric	0.906	0.906	1.181	0.132
84318	17 mm	6 Pt. Std. Metric	0.945	0.945	1.181	0.143
84319	18 mm	6 Pt. Std. Metric	0.984	0.984	1.181	0.154
84320	19 mm	6 Pt. Std. Metric	1.024	1.024	1.181	0.154

3/8" OPEN STOCK
IMPACT SOCKETS



6 Pt. Deep Impact Sockets SAE/METRIC 3/8" DRIVE

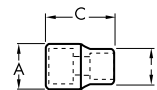

IMPACT SOCKETS 3/8" OPEN STOCK

Item No.	Size	Description	Drive End (inch) A	Wrench End (inch) B	Overall Length (inch) C	Weight (lbs)
84322	5/16"	6 Pt. Deep SAE	0.748	0.496	2.52	0.209
84323	3/8"	6 Pt. Deep SAE	0.748	0.575	2.52	0.209
84324	7/16"	6 Pt. Deep SAE	0.748	0.673	2.52	0.209
84325	1/2"	6 Pt. Deep SAE	0.787	0.787	2.52	0.221
84326	9/16"	6 Pt. Deep SAE	0.827	0.827	2.52	0.221
84327	5/8"	6 Pt. Deep SAE	0.906	0.906	2.52	0.221
84328	11/16"	6 Pt. Deep SAE	0.906	0.906	2.52	0.221
84329	3/4"	6 Pt. Deep SAE	0.906	0.906	2.52	0.221
84331	8 mm	6 Pt. Deep Metric	0.748	0.598	2.52	0.209
84332	9 mm	6 Pt. Deep Metric	0.748	0.551	2.52	0.209
84333	10 mm	6 Pt. Deep Metric	0.748	0.598	2.52	0.209
84334	11 mm	6 Pt. Deep Metric	0.748	0.669	2.52	0.209
84335	12 mm	6 Pt. Deep Metric	0.748	0.748	2.52	0.221
84336	13 mm	6 Pt. Deep Metric	0.787	0.787	2.52	0.221
84337	14 mm	6 Pt. Deep Metric	0.827	0.827	2.52	0.221
84338	15 mm	6 Pt. Deep Metric	0.866	0.866	2.52	0.265
84339	16 mm	6 Pt. Deep Metric	0.906	0.906	2.52	0.265
84340	17 mm	6 Pt. Deep Metric	0.945	0.945	2.52	0.276
84341	18 mm	6 Pt. Deep Metric	0.984	0.984	2.52	0.309
84342	19 mm	6 Pt. Deep Metric	1.024	1.024	2.52	0.309
84343	21 mm	6 Pt. Deep Metric	1.102	1.102	2.52	0.353

6 Pt. Hex Impact Sockets SAE/METRIC 3/8" DRIVE

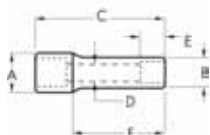

Item No.	Size	Description	Drive End (inch) A	Overall Length (inch) C	Weight (lbs)
84397	3/16"	6 Pt. Hex SAE	0.827	1.968	0.094
84398	7/32"	6 Pt. Hex SAE	0.827	1.968	0.099
84399	1/4"	6 Pt. Hex SAE	0.827	1.968	0.099
84400	5/16"	6 Pt. Hex SAE	0.827	1.968	0.107
84401	3/8"	6 Pt. Hex SAE	0.827	1.968	0.158
84402	7/16"	6 Pt. Hex SAE	0.827	1.968	0.165
84403	1/2"	6 Pt. Hex SAE	0.827	1.968	0.178
84389	4 mm	6 Pt. Hex Metric	0.827	1.968	0.094
84390	5 mm	6 Pt. Hex Metric	0.827	1.968	0.099
84391	6 mm	6 Pt. Hex Metric	0.827	1.968	0.099
84392	7 mm	6 Pt. Hex Metric	0.827	1.968	0.107
84393	8 mm	6 Pt. Hex Metric	0.827	1.968	0.107
84394	10 mm	6 Pt. Hex Metric	0.827	1.968	0.107
84395	12 mm	6 Pt. Hex Metric	0.827	1.968	0.160

3/8" OPEN STOCK
IMPACT SOCKETS



6 Pt. Universal Impact Sockets SAE/METRIC 3/8" DRIVE

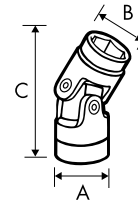

Item No.	Size	Description	Drive End (inch) A	Wrench End (inch) B	Overall Length (inch) C	Weight (lbs)
84345	5/16"	6 Pt. Unv. SAE	0.945	0.551	2.047	0.223
84346	3/8"	6 Pt. Unv. SAE	0.945	0.709	2.047	0.243
84347	7/16"	6 Pt. Unv. SAE	0.945	0.756	2.047	0.247
84348	1/2"	6 Pt. Unv. SAE	0.945	0.866	2.047	0.262
84349	9/16"	6 Pt. Unv. SAE	0.945	0.866	2.047	0.262
84350	5/8"	6 Pt. Unv. SAE	0.945	1.024	2.047	0.284
84351	11/16"	6 Pt. Unv. SAE	0.945	1.055	2.047	0.284
84352	3/4"	6 Pt. Unv. SAE	0.945	1.102	2.047	0.282
84354	8 mm	6 Pt. Unv. Metric	0.945	0.551	2.047	0.223
84355	9 mm	6 Pt. Unv. Metric	0.945	0.638	2.047	0.238
84356	10 mm	6 Pt. Unv. Metric	0.945	0.709	2.047	0.241
84357	11 mm	6 Pt. Unv. Metric	0.945	0.756	2.047	0.247
84358	12 mm	6 Pt. Unv. Metric	0.945	0.756	2.047	0.243
84359	13 mm	6 Pt. Unv. Metric	0.945	0.866	2.047	0.262
84360	14 mm	6 Pt. Unv. Metric	0.945	0.866	2.047	0.262
84361	15 mm	6 Pt. Unv. Metric	0.945	0.866	2.047	0.255
84362	16 mm	6 Pt. Unv. Metric	0.945	1.024	2.047	0.284
84363	17 mm	6 Pt. Unv. Metric	0.945	1.055	2.047	0.284
84364	18 mm	6 Pt. Unv. Metric	0.945	1.063	2.047	0.282
84365	19 mm	6 Pt. Unv. Metric	0.945	1.102	2.047	0.282
84366	20 mm	6 Pt. Unv. Metric	0.945	1.181	2.047	0.303
84367	21 mm	6 Pt. Unv. Metric	0.945	1.26	2.047	0.318
84368	22 mm	6 Pt. Unv. Metric	0.945	1.26	2.047	0.309

IMPACT SOCKETS 3/8" OPEN STOCK



**84931 - 12 Pc. Impact SAE Standard Socket Set
1/2" DRIVE**

Item No.	Description			
84500	3/8"	6 Pt.	Std. SAE Socket	1/2" Dr.
84501	7/16"	6 Pt.	Std. SAE Socket	1/2" Dr.
84502	1/2"	6 Pt.	Std. SAE Socket	1/2" Dr.

Item No.	Description			
84503	9/16"	6 Pt.	Std. SAE Socket	1/2" Dr.
84504	5/8"	6 Pt.	Std. SAE Socket	1/2" Dr.
84505	11/16"	6 Pt.	Std. SAE Socket	1/2" Dr.
84506	3/4"	6 Pt.	Std. SAE Socket	1/2" Dr.
84507	13/16"	6 Pt.	Std. SAE Socket	1/2" Dr.
84508	7/8"	6 Pt.	Std. SAE Socket	1/2" Dr.
84509	15/16"	6 Pt.	Std. SAE Socket	1/2" Dr.
84510	1"	6 Pt.	Std. SAE Socket	1/2" Dr.
84511	1-1/16"	6 Pt.	Std. SAE Socket	1/2" Dr.



**84930 - 12 Pc. Impact METRIC Standard Socket Set
1/2" DRIVE**

Item No.	Description			
84520	8 mm	6 Pt.	Std. Metric Socket	1/2" Dr.
84521	9 mm	6 Pt.	Std. Metric Socket	1/2" Dr.
84522	10 mm	6 Pt.	Std. Metric Socket	1/2" Dr.

Item No.	Description			
84523	11 mm	6 Pt.	Std. Metric Socket	1/2" Dr.
84524	12 mm	6 Pt.	Std. Metric Socket	1/2" Dr.
84525	13 mm	6 Pt.	Std. Metric Socket	1/2" Dr.
84526	14 mm	6 Pt.	Std. Metric Socket	1/2" Dr.
84527	15 mm	6 Pt.	Std. Metric Socket	1/2" Dr.
84528	16 mm	6 Pt.	Std. Metric Socket	1/2" Dr.
84529	17 mm	6 Pt.	Std. Metric Socket	1/2" Dr.
84530	18 mm	6 Pt.	Std. Metric Socket	1/2" Dr.
84531	19 mm	6 Pt.	Std. Metric Socket	1/2" Dr.



**84932 - 19 Pc. Impact SAE Standard Socket Set
1/2" DRIVE**

Item No.	Description			
84500	3/8"	6 Pt.	Std. SAE Socket	1/2" Dr.
84501	7/16"	6 Pt.	Std. SAE Socket	1/2" Dr.
84502	1/2"	6 Pt.	Std. SAE Socket	1/2" Dr.
84503	9/16"	6 Pt.	Std. SAE Socket	1/2" Dr.
84504	5/8"	6 Pt.	Std. SAE Socket	1/2" Dr.
84505	11/16"	6 Pt.	Std. SAE Socket	1/2" Dr.

Item No.	Description			
84506	3/4"	6 Pt.	Std. SAE Socket	1/2" Dr.
84507	13/16"	6 Pt.	Std. SAE Socket	1/2" Dr.
84508	7/8"	6 Pt.	Std. SAE Socket	1/2" Dr.
84509	15/16"	6 Pt.	Std. SAE Socket	1/2" Dr.
84510	1"	6 Pt.	Std. SAE Socket	1/2" Dr.
84511	1-1/16"	6 Pt.	Std. SAE Socket	1/2" Dr.
84512	1-1/8"	6 Pt.	Std. SAE Socket	1/2" Dr.
84513	1-3/16"	6 Pt.	Std. SAE Socket	1/2" Dr.
84514	1-1/4"	6 Pt.	Std. SAE Socket	1/2" Dr.
84515	1-5/16"	6 Pt.	Std. SAE Socket	1/2" Dr.
84516	1-3/8"	6 Pt.	Std. SAE Socket	1/2" Dr.
84517	1-7/16"	6 Pt.	Std. SAE Socket	1/2" Dr.
84518	1-1/2"	6 Pt.	Std. SAE Socket	1/2" Dr.



84933 - 25 Pc. Impact METRIC Standard Socket Set 1/2" DRIVE

Item No.	Description			
84527	15 mm	6 Pt.	Std. Metric Socket	1/2" Dr.
84528	16 mm	6 Pt.	Std. Metric Socket	1/2" Dr.
84529	17 mm	6 Pt.	Std. Metric Socket	1/2" Dr.
84530	18 mm	6 Pt.	Std. Metric Socket	1/2" Dr.
84531	19 mm	6 Pt.	Std. Metric Socket	1/2" Dr.
84532	20 mm	6 Pt.	Std. Metric Socket	1/2" Dr.
84533	21 mm	6 Pt.	Std. Metric Socket	1/2" Dr.
84534	22 mm	6 Pt.	Std. Metric Socket	1/2" Dr.
84535	23 mm	6 Pt.	Std. Metric Socket	1/2" Dr.
84536	24 mm	6 Pt.	Std. Metric Socket	1/2" Dr.
84537	25 mm	6 Pt.	Std. Metric Socket	1/2" Dr.
84538	26 mm	6 Pt.	Std. Metric Socket	1/2" Dr.
84539	28 mm	6 Pt.	Std. Metric Socket	1/2" Dr.
84540	29 mm	6 Pt.	Std. Metric Socket	1/2" Dr.
84541	30 mm	6 Pt.	Std. Metric Socket	1/2" Dr.
84542	31 mm	6 Pt.	Std. Metric Socket	1/2" Dr.
84543	32 mm	6 Pt.	Std. Metric Socket	1/2" Dr.
84544	36 mm	6 Pt.	Std. Metric Socket	1/2" Dr.

Item No.	Description			
84520	8 mm	6 Pt.	Std. Metric Socket	1/2" Dr.
84521	9 mm	6 Pt.	Std. Metric Socket	1/2" Dr.
84522	10 mm	6 Pt.	Std. Metric Socket	1/2" Dr.
84523	11 mm	6 Pt.	Std. Metric Socket	1/2" Dr.
84524	12 mm	6 Pt.	Std. Metric Socket	1/2" Dr.
84525	13 mm	6 Pt.	Std. Metric Socket	1/2" Dr.
84526	14 mm	6 Pt.	Std. Metric Socket	1/2" Dr.



84942 - 12 Pc. Impact SAE Deep Socket Set 1/2" DRIVE

Item No.	Description			
84546	3/8"	6 Pt.	Deep SAE Socket	1/2" Dr.
84547	7/16"	6 Pt.	Deep SAE Socket	1/2" Dr.
84548	1/2"	6 Pt.	Deep SAE Socket	1/2" Dr.
84549	9/16"	6 Pt.	Deep SAE Socket	1/2" Dr.
84550	5/8"	6 Pt.	Deep SAE Socket	1/2" Dr.
84551	11/16"	6 Pt.	Deep SAE Socket	1/2" Dr.
84552	3/4"	6 Pt.	Deep SAE Socket	1/2" Dr.
84553	13/16"	6 Pt.	Deep SAE Socket	1/2" Dr.
84554	7/8"	6 Pt.	Deep SAE Socket	1/2" Dr.
84555	15/16"	6 Pt.	Deep SAE Socket	1/2" Dr.
84556	1"	6 Pt.	Deep SAE Socket	1/2" Dr.
84557	1-1/16"	6 Pt.	Deep SAE Socket	1/2" Dr.

1/2" DRIVE SETS

IMPACT SOCKETS

**84944 - 12 Pc. Impact METRIC Deep Socket Set
1/2" DRIVE**

Item No.	Description		
84566	8 mm	6 Pt. Deep Metric Socket	1/2" Dr.
84567	9 mm	6 Pt. Deep Metric Socket	1/2" Dr.
84568	10 mm	6 Pt. Deep Metric Socket	1/2" Dr.
84569	11 mm	6 Pt. Deep Metric Socket	1/2" Dr.
84570	12 mm	6 Pt. Deep Metric Socket	1/2" Dr.
84571	13 mm	6 Pt. Deep Metric Socket	1/2" Dr.
84572	14 mm	6 Pt. Deep Metric Socket	1/2" Dr.
84573	15 mm	6 Pt. Deep Metric Socket	1/2" Dr.
84574	16 mm	6 Pt. Deep Metric Socket	1/2" Dr.
84575	17 mm	6 Pt. Deep Metric Socket	1/2" Dr.
84576	18 mm	6 Pt. Deep Metric Socket	1/2" Dr.
84577	19 mm	6 Pt. Deep Metric Socket	1/2" Dr.



**84934 - 19 Pc. Impact SAE Deep Socket Set
1/2" DRIVE**

Item No.	Description		
84546	3/8"	6 Pt. Deep SAE Socket	1/2" Dr.
84547	7/16"	6 Pt. Deep SAE Socket	1/2" Dr.
84548	1/2"	6 Pt. Deep SAE Socket	1/2" Dr.
84549	9/16"	6 Pt. Deep SAE Socket	1/2" Dr.
84550	5/8"	6 Pt. Deep SAE Socket	1/2" Dr.
84551	11/16"	6 Pt. Deep SAE Socket	1/2" Dr.
84552	3/4"	6 Pt. Deep SAE Socket	1/2" Dr.
84553	13/16"	6 Pt. Deep SAE Socket	1/2" Dr.
84554	7/8"	6 Pt. Deep SAE Socket	1/2" Dr.
84555	15/16"	6 Pt. Deep SAE Socket	1/2" Dr.
84556	1"	6 Pt. Deep SAE Socket	1/2" Dr.
84557	1-1/16"	6 Pt. Deep SAE Socket	1/2" Dr.
84558	1-1/8"	6 Pt. Deep SAE Socket	1/2" Dr.
84559	1-13/16"	6 Pt. Deep SAE Socket	1/2" Dr.
84560	1-1/4"	6 Pt. Deep SAE Socket	1/2" Dr.
84561	1-5/16"	6 Pt. Deep SAE Socket	1/2" Dr.
84562	1-3/8"	6 Pt. Deep SAE Socket	1/2" Dr.
84563	1-7/16"	6 Pt. Deep SAE Socket	1/2" Dr.
84564	1-1/2"	6 Pt. Deep SAE Socket	1/2" Dr.



1/2" DRIVE SETS

IMPACT SOCKETS



**84935 - 29 Pc. Impact METRIC Deep Socket Set
1/2" DRIVE**

Item No.	Description			
84574	16 mm	6 Pt.	Deep Metric Socket	1/2" Dr.
84575	17 mm	6 Pt.	Deep Metric Socket	1/2" Dr.
84576	18 mm	6 Pt.	Deep Metric Socket	1/2" Dr.
84577	19 mm	6 Pt.	Deep Metric Socket	1/2" Dr.
84578	20 mm	6 Pt.	Deep Metric Socket	1/2" Dr.
84579	21 mm	6 Pt.	Deep Metric Socket	1/2" Dr.
84580	22 mm	6 Pt.	Deep Metric Socket	1/2" Dr.
84581	23 mm	6 Pt.	Deep Metric Socket	1/2" Dr.
84582	24 mm	6 Pt.	Deep Metric Socket	1/2" Dr.
84583	25 mm	6 Pt.	Deep Metric Socket	1/2" Dr.
84584	26 mm	6 Pt.	Deep Metric Socket	1/2" Dr.
84585	27 mm	6 Pt.	Deep Metric Socket	1/2" Dr.
84586	28 mm	6 Pt.	Deep Metric Socket	1/2" Dr.
84587	29 mm	6 Pt.	Deep Metric Socket	1/2" Dr.
84588	30 mm	6 Pt.	Deep Metric Socket	1/2" Dr.
84589	31 mm	6 Pt.	Deep Metric Socket	1/2" Dr.
84590	32 mm	6 Pt.	Deep Metric Socket	1/2" Dr.
84591	33 mm	6 Pt.	Deep Metric Socket	1/2" Dr.
84592	34 mm	6 Pt.	Deep Metric Socket	1/2" Dr.
84593	35 mm	6 Pt.	Deep Metric Socket	1/2" Dr.
84594	36 mm	6 Pt.	Deep Metric Socket	1/2" Dr.

Item No.	Description			
84566	8 mm	6 Pt.	Deep Metric Socket	1/2" Dr.
84567	9 mm	6 Pt.	Deep Metric Socket	1/2" Dr.
84568	10 mm	6 Pt.	Deep Metric Socket	1/2" Dr.
84569	11 mm	6 Pt.	Deep Metric Socket	1/2" Dr.
84570	12 mm	6 Pt.	Deep Metric Socket	1/2" Dr.
84571	13 mm	6 Pt.	Deep Metric Socket	1/2" Dr.
84572	14 mm	6 Pt.	Deep Metric Socket	1/2" Dr.
84573	15 mm	6 Pt.	Deep Metric Socket	1/2" Dr.



**84940 - 7 Pc. Impact SAE HEX Socket Set
1/2" DRIVE**

Item No.	Description			
84634	3/8"	6 Pt.	Hex Bit SAE Socket	1/2" Dr.
84635	7/16"	6 Pt.	Hex Bit SAE Socket	1/2" Dr.
84636	1/2"	6 Pt.	Hex Bit SAE Socket	1/2" Dr.
84637	9/16"	6 Pt.	Hex Bit SAE Socket	1/2" Dr.
84638	5/8"	6 Pt.	Hex Bit SAE Socket	1/2" Dr.
84639	11/16"	6 Pt.	Hex Bit SAE Socket	1/2" Dr.
84640	3/4"	6 Pt.	Hex Bit SAE Socket	1/2" Dr.

IMPACT SOCKETS 1/2" DRIVE SETS

84941 - 7 Pc. Impact METRIC HEX Socket Set 1/2" DRIVE

Item No.	Description	
84626	9 mm	6 Pt. Hex Bit Metric Socket 1/2" Dr.
84627	10 mm	6 Pt. Hex Bit Metric Socket 1/2" Dr.
84628	11 mm	6 Pt. Hex Bit Metric Socket 1/2" Dr.
84629	12 mm	6 Pt. Hex Bit Metric Socket 1/2" Dr.
84630	13 mm	6 Pt. Hex Bit Metric Socket 1/2" Dr.
84631	14 mm	6 Pt. Hex Bit Metric Socket 1/2" Dr.
84632	15 mm	6 Pt. Hex Bit Metric Socket 1/2" Dr.



84938 - 13 Pc. Impact SAE Universal Socket Set 1/2" DRIVE

Item No.	Description	
84596	1/2"	6 Pt. Unv. SAE Socket 1/2" Dr.
84597	9/16"	6 Pt. Unv. SAE Socket 1/2" Dr.
84598	5/8"	6 Pt. Unv. SAE Socket 1/2" Dr.
84599	11/16"	6 Pt. Unv. SAE Socket 1/2" Dr.
84600	3/4"	6 Pt. Unv. SAE Socket 1/2" Dr.
84601	13/16"	6 Pt. Unv. SAE Socket 1/2" Dr.
84602	7/8"	6 Pt. Unv. SAE Socket 1/2" Dr.
84603	15/16"	6 Pt. Unv. SAE Socket 1/2" Dr.
84604	1"	6 Pt. Unv. SAE Socket 1/2" Dr.
84605	1-1/16"	6 Pt. Unv. SAE Socket 1/2" Dr.
84606	1-1/8"	6 Pt. Unv. SAE Socket 1/2" Dr.



Item No.	Description	
84607	1-3/16"	6 Pt. Unv. SAE Socket 1/2" Dr.
84608	1-1/4"	6 Pt. Unv. SAE Socket 1/2" Dr.

84939 - 15 Pc. Impact METRIC Universal Socket Set 1/2" DRIVE

Item No.	Description	
84610	10 mm	6 Pt. Unv. Metric Socket 1/2" Dr.
84611	11 mm	6 Pt. Unv. Metric Socket 1/2" Dr.
84612	12 mm	6 Pt. Unv. Metric Socket 1/2" Dr.
84613	13 mm	6 Pt. Unv. Metric Socket 1/2" Dr.
84614	14 mm	6 Pt. Unv. Metric Socket 1/2" Dr.
84615	15 mm	6 Pt. Unv. Metric Socket 1/2" Dr.
84616	16 mm	6 Pt. Unv. Metric Socket 1/2" Dr.
84617	17 mm	6 Pt. Unv. Metric Socket 1/2" Dr.
84618	18 mm	6 Pt. Unv. Metric Socket 1/2" Dr.
84619	19 mm	6 Pt. Unv. Metric Socket 1/2" Dr.
84620	20 mm	6 Pt. Unv. Metric Socket 1/2" Dr.
84621	21 mm	6 Pt. Unv. Metric Socket 1/2" Dr.



Item No.	Description	
84622	22 mm	6 Pt. Unv. Metric Socket 1/2" Dr.
84623	23 mm	6 Pt. Unv. Metric Socket 1/2" Dr.
84624	24 mm	6 Pt. Unv. Metric Socket 1/2" Dr.

1/2" DRIVE SETS
IMPACT SOCKETS



Impact Extension Bars SAE 1/2" DRIVE

Item No.	Description	Weight (lbs)
84645	3" Extension Bar	0.315
84646	5" Extension Bar	0.498
84644	10" Extension Bar	0.492



Standard Impact Adapters SAE 1/2" DRIVE

Item No.	Description	Weight (lbs)
84643	1/2" F x 3/8" M	0.154



Universal Impact Joints SAE 1/2" DRIVE

Item No.	Description	Weight (lbs)
80671	1/2" Universal Joint	0.374

1/2" OPEN STOCK
IMPACT SOCKETS

6 Pt. Standard Impact Sockets SAE/METRIC 1/2" DRIVE

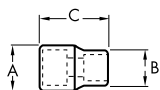

Item No.	Size	Description	Drive End (inch) A	Wrench End (inch) B	Overall Length (inch) C	Weight (lbs)
84500	3/8"	6 Pt. Std. SAE	0.866	0.63	1.496	0.143
84501	7/16"	6 Pt. Std. SAE	0.866	0.709	1.496	0.143
84502	1/2"	6 Pt. Std. SAE	0.866	0.787	1.496	0.143
84503	9/16"	6 Pt. Std. SAE	0.945	0.866	1.496	0.176
84504	5/8"	6 Pt. Std. SAE	0.984	0.984	1.496	0.194
84505	11/16"	6 Pt. Std. SAE	1.024	1.024	1.496	0.209
84506	3/4"	6 Pt. Std. SAE	1.102	1.102	1.496	0.234
84507	13/16"	6 Pt. Std. SAE	1.181	1.181	1.496	0.265
84508	7/8"	6 Pt. Std. SAE	1.26	1.26	1.496	0.32
84509	15/16"	6 Pt. Std. SAE	1.339	1.339	1.496	0.357
84510	1"	6 Pt. Std. SAE	1.417	1.417	1.496	0.419
84511	1-1/16"	6 Pt. Std. SAE	1.496	1.496	1.575	0.467
84512	1-1/8"	6 Pt. Std. SAE	1.496	1.575	1.575	0.492
84513	1-3/16"	6 Pt. Std. SAE	1.496	1.654	1.575	0.518
84514	1-1/4"	6 Pt. Std. SAE	1.496	1.732	1.575	0.551

1/2" OPEN STOCK
IMPACT SOCKETS



6 Pt. Standard Impact Sockets SAE/METRIC 1/2" DRIVE

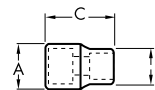

Item No.	Size	Description	Drive End (inch) A	Wrench End (inch) B	Overall Length (inch) C	Weight (lbs)
84515	1-5/16"	6 Pt. Std. SAE	1.496	1.772	1.693	0.646
84516	1-3/8"	6 Pt. Std. SAE	1.496	1.85	1.693	0.675
84517	1-7/16"	6 Pt. Std. SAE	1.496	1.89	1.693	0.679
84518	1-1/2"	6 Pt. Std. SAE	1.496	1.968	1.693	0.765
84520	8 mm	6 Pt. Std. Metric	0.866	0.571	1.496	0.11
84521	9 mm	6 Pt. Std. Metric	0.866	0.614	1.496	0.11
84522	10 mm	6 Pt. Std. Metric	0.866	0.657	1.496	0.143
84523	11 mm	6 Pt. Std. Metric	0.866	0.709	1.496	0.143
84524	12 mm	6 Pt. Std. Metric	0.866	0.748	1.496	0.143
84525	13 mm	6 Pt. Std. Metric	0.945	0.795	1.496	0.176
84526	14 mm	6 Pt. Std. Metric	0.945	0.846	1.496	0.176
84527	15 mm	6 Pt. Std. Metric	0.984	0.906	1.496	0.192
84528	16 mm	6 Pt. Std. Metric	0.984	0.984	1.496	0.192
84529	17 mm	6 Pt. Std. Metric	1.024	1.024	1.496	0.209
84530	18 mm	6 Pt. Std. Metric	1.063	1.063	1.496	0.225
84531	19 mm	6 Pt. Std. Metric	1.102	1.102	1.496	0.232
84532	20 mm	6 Pt. Std. Metric	1.181	1.181	1.496	0.276
84533	21 mm	6 Pt. Std. Metric	1.181	1.181	1.496	0.276
84534	22 mm	6 Pt. Std. Metric	1.26	1.26	1.496	0.318
84535	23 mm	6 Pt. Std. Metric	1.299	1.299	1.496	0.34
84536	24 mm	6 Pt. Std. Metric	1.339	1.339	1.496	0.353
84537	25 mm	6 Pt. Std. Metric	1.417	1.417	1.654	0.443
84538	26 mm	6 Pt. Std. Metric	1.417	1.417	1.654	0.43
84539	28 mm	6 Pt. Std. Metric	1.496	1.496	1.654	0.494
84540	29 mm	6 Pt. Std. Metric	1.614	1.614	1.654	0.584
84541	30 mm	6 Pt. Std. Metric	1.496	1.654	1.654	0.558
84542	31 mm	6 Pt. Std. Metric	1.496	1.654	1.654	0.558
84543	32 mm	6 Pt. Std. Metric	1.496	1.732	1.654	0.573
84544	36 mm	6 Pt. Std. Metric	1.496	1.968	1.968	0.573

IMPACT SOCKETS 1/2" OPEN STOCK

6 Pt. Deep Impact Sockets SAE/METRIC 1/2" DRIVE

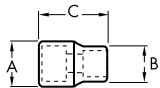

Item No.	Size	Description	Drive End (inch) A	Wrench End (inch) B	Overall Length (inch) C	Weight (lbs)
84546	3/8"	6 Pt. Deep SAE	0.866	0.63	3.071	0.331
84547	7/16"	6 Pt. Deep SAE	0.866	0.709	3.071	0.335
84548	1/2"	6 Pt. Deep SAE	0.866	0.787	3.071	0.335
84549	9/16"	6 Pt. Deep SAE	0.945	0.866	3.071	0.368
84550	5/8"	6 Pt. Deep SAE	0.984	0.984	3.071	0.401
84551	11/16"	6 Pt. Deep SAE	1.024	1.024	3.071	0.419
84552	3/4"	6 Pt. Deep SAE	1.102	1.102	3.071	0.485
84553	13/16"	6 Pt. Deep SAE	1.181	1.181	3.071	0.54
84554	7/8"	6 Pt. Deep SAE	1.26	1.26	3.071	0.624
84555	15/16"	6 Pt. Deep SAE	1.339	1.339	3.071	0.706
84556	1"	6 Pt. Deep SAE	1.417	1.417	3.071	0.807
84557	1-1/16"	6 Pt. Deep SAE	1.496	1.496	3.071	0.915
84558	1-1/8"	6 Pt. Deep SAE	1.496	1.575	3.071	0.937
84560	1-1/4"	6 Pt. Deep SAE	1.496	1.732	3.071	1.08
84561	1-5/16"	6 Pt. Deep SAE	1.496	1.772	3.071	1.224
84562	1-3/8"	6 Pt. Deep SAE	1.496	1.85	3.071	1.259
84563	1-7/16"	6 Pt. Deep SAE	1.496	1.89	3.071	1.336
84564	1-1/2"	6 Pt. Deep SAE	1.496	1.968	3.071	1.413
84559	1-13/16"	6 Pt. Deep SAE	1.496	1.654	3.071	1.036
84566	8 mm	6 Pt. Deep Metric	0.866	0.571	3.071	0.309
84567	9 mm	6 Pt. Deep Metric	0.866	0.614	3.071	0.309
84568	10 mm	6 Pt. Deep Metric	0.866	0.657	3.071	0.335
84569	11 mm	6 Pt. Deep Metric	0.866	0.709	3.071	0.342
84570	12 mm	6 Pt. Deep Metric	0.866	0.748	3.071	0.331
84571	13 mm	6 Pt. Deep Metric	0.945	0.795	3.071	0.386

1/2" OPEN STOCK
IMPACT SOCKETS



6 Pt. Deep Impact Sockets SAE/METRIC 1/2" DRIVE

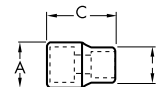

Item No.	Size	Description	Drive End (inch) A	Wrench End (inch) B	Overall Length (inch) C	Weight (lbs)
84572	14 mm	6 Pt. Deep Metric	0.945	0.846	3.071	0.37
84573	15 mm	6 Pt. Deep Metric	0.945	0.945	3.071	0.377
84574	16 mm	6 Pt. Deep Metric	0.984	0.984	3.071	0.426
84575	17 mm	6 Pt. Deep Metric	1.024	1.024	3.071	0.419
84576	18 mm	6 Pt. Deep Metric	1.024	1.024	3.071	0.397
84577	19 mm	6 Pt. Deep Metric	1.102	1.102	3.071	0.485
84578	20 mm	6 Pt. Deep Metric	1.181	1.181	3.071	0.573
84579	21 mm	6 Pt. Deep Metric	1.181	1.181	3.071	0.54
84580	22 mm	6 Pt. Deep Metric	1.26	1.26	3.071	0.631
84581	23 mm	6 Pt. Deep Metric	1.26	1.26	3.071	0.609
84582	24 mm	6 Pt. Deep Metric	1.339	1.339	3.071	0.692
84583	25 mm	6 Pt. Deep Metric	1.417	1.417	3.071	0.794
84584	26 mm	6 Pt. Deep Metric	1.417	1.417	3.071	0.798
84585	27 mm	6 Pt. Deep Metric	1.496	1.496	3.071	0.893
84586	28 mm	6 Pt. Deep Metric	1.575	1.575	3.071	0.983
84587	29 mm	6 Pt. Deep Metric	1.575	1.575	3.071	0.959
84588	30 mm	6 Pt. Deep Metric	1.496	1.654	3.071	0.999
84589	31 mm	6 Pt. Deep Metric	1.496	1.732	3.071	1.036
84590	32 mm	6 Pt. Deep Metric	1.496	1.732	3.071	1.091
84591	33 mm	6 Pt. Deep Metric	1.496	1.811	3.071	1.105
84592	34 mm	6 Pt. Deep Metric	1.496	1.89	3.071	1.129
84593	35 mm	6 Pt. Deep Metric	1.496	1.89	3.071	1.158
84594	36 mm	6 Pt. Deep Metric	1.496	1.968	3.071	1.235

IMPACT SOCKETS 1/2" OPEN STOCK

6 Pt. Hex Impact Sockets SAE/METRIC 1/2" DRIVE

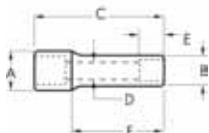

Item No.	Size	Description	Drive End (inch) A	Overall Length (inch) C	Weight (lbs)
84634	3/8"	6 Pt. Hex SAE	0.984	3.071	0.233
84635	7/16"	6 Pt. Hex SAE	0.984	3.071	0.244
84636	1/2"	6 Pt. Hex SAE	0.984	3.071	0.277
84637	9/16"	6 Pt. Hex SAE	0.984	3.071	0.334
84638	5/8"	6 Pt. Hex SAE	0.984	3.071	0.343
84639	11/16"	6 Pt. Hex SAE	0.984	3.071	0.437
84640	3/4"	6 Pt. Hex SAE	0.984	3.071	0.437
84626	9 mm	6 Pt. Hex Metric	0.984	3.071	0.237
84627	10 mm	6 Pt. Hex Metric	0.984	3.071	0.290
84628	11 mm	6 Pt. Hex Metric	0.984	3.071	0.352
84629	12 mm	6 Pt. Hex Metric	0.984	3.071	0.426
84630	13 mm	6 Pt. Hex Metric	0.984	3.071	0.426
84631	14 mm	6 Pt. Hex Metric	0.984	3.071	0.437
84632	15 mm	6 Pt. Hex Metric	0.984	3.071	0.437

1/2" OPEN STOCK
IMPACT SOCKETS



6 Pt. Universal Impact Sockets SAE/METRIC 1/2" DRIVE

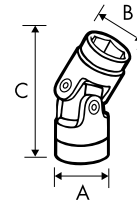

IMPACT SOCKETS 1/2" OPEN STOCK

Item No.	Size	Description	Drive End (inch) A	Wrench End (inch) B	Overall Length (inch) C	Weight (lbs)
84596	1/2"	6 Pt. Unv. SAE	1.083	0.748	2.598	0.375
84597	9/16"	6 Pt. Unv. SAE	1.083	0.866	2.598	0.406
84598	5/8"	6 Pt. Unv. SAE	1.083	0.945	2.598	0.415
84599	11/16"	6 Pt. Unv. SAE	1.083	1.024	2.598	0.388
84600	3/4"	6 Pt. Unv. SAE	1.083	1.102	2.598	0.441
84601	13/16"	6 Pt. Unv. SAE	1.083	1.181	2.598	0.45
84602	7/8"	6 Pt. Unv. SAE	1.083	1.26	2.598	0.463
84603	15/16"	6 Pt. Unv. SAE	1.083	1.378	2.598	0.507
84604	1"	6 Pt. Unv. SAE	1.083	1.389	2.598	0.511
84605	1-1/16"	6 Pt. Unv. SAE	1.083	1.562	2.598	0.612
84606	1-1/8"	6 Pt. Unv. SAE	1.083	1.781	2.598	0.734
84607	1-3/16"	6 Pt. Unv. SAE	1.083	1.802	2.598	0.851
84608	1-1/4"	6 Pt. Unv. SAE	1.083	1.947	2.598	0.912
84610	10 mm	6 Pt. Unv. Metric	1.083	0.709	2.598	0.381
84611	11 mm	6 Pt. Unv. Metric	1.083	0.748	2.598	0.386
84612	12 mm	6 Pt. Unv. Metric	1.083	0.748	2.598	0.375
84613	13 mm	6 Pt. Unv. Metric	1.083	0.866	2.598	0.408
84614	14 mm	6 Pt. Unv. Metric	1.083	0.866	2.598	0.406
84615	15 mm	6 Pt. Unv. Metric	1.083	0.866	2.598	0.397
84616	16 mm	6 Pt. Unv. Metric	1.083	0.945	2.598	0.415
84617	17 mm	6 Pt. Unv. Metric	1.083	0.984	2.598	0.401
84618	18 mm	6 Pt. Unv. Metric	1.083	1.024	2.598	0.388
84619	19 mm	6 Pt. Unv. Metric	1.083	1.102	2.598	0.441
84620	20 mm	6 Pt. Unv. Metric	1.083	1.181	2.598	0.452
84621	21 mm	6 Pt. Unv. Metric	1.083	1.181	2.598	0.45
84622	22 mm	6 Pt. Unv. Metric	1.083	1.26	2.598	0.463
84623	23 mm	6 Pt. Unv. Metric	1.083	1.26	2.598	0.459
84624	24 mm	6 Pt. Unv. Metric	1.083	1.378	2.598	0.507

Impact Extension Bars SAE 3/4" DRIVE

Item No.	Description	Weight (lbs)
84885	6" Extension Bar	1.742
84886	10" Extension Bar	2.58



Standard Impact Adapters SAE 3/4" DRIVE

Item No.	Description	Weight (lbs)
84888	3/4" F X 1/2" M Impact Adapter	0.725
84887	3/4" F X 1" M Impact Adapter	1.552





6 Pt. Standard Impact Sockets SAE/METRIC 3/4" DRIVE

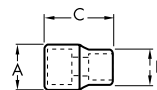

Item No.	Size	Description	Drive End (inch) A	Wrench End (inch) B	Overall Length (inch) C	Weight (lbs)
84800	3/4"	6 Pt. Std. SAE	1.654	1.260	2.008	0.662
84801	13/16"	6 Pt. Std. SAE	1.654	1.378	2.008	0.706
84802	7/8"	6 Pt. Std. SAE	1.654	1.417	2.008	0.706
84803	15/16"	6 Pt. Std. SAE	1.654	1.496	2.008	0.750
84804	1"	6 Pt. Std. SAE	1.654	1.575	2.087	0.750
84805	1-1/16"	6 Pt. Std. SAE	1.732	1.654	2.087	0.838
84806	1-1/8"	6 Pt. Std. SAE	1.732	1.732	2.087	0.860
84808	1-1/4"	6 Pt. Std. SAE	1.732	1.890	2.244	0.992
84809	1-5/16"	6 Pt. Std. SAE	1.732	1.968	2.244	1.080
84810	1-3/8"	6 Pt. Std. SAE	1.732	2.047	2.244	1.102
84811	1-7/16"	6 Pt. Std. SAE	1.732	2.087	2.244	1.102
84812	1-1/2"	6 Pt. Std. SAE	1.732	2.205	2.244	1.147
84813	1-9/16"	6 Pt. Std. SAE	1.732	2.283	2.283	1.257
84814	1-5/8"	6 Pt. Std. SAE	1.732	2.362	2.283	1.301
84815	1-11/16"	6 Pt. Std. SAE	1.732	2.441	2.441	1.433
84816	1-3/4"	6 Pt. Std. SAE	1.732	2.520	2.441	1.477
84807	1-13/16"	6 Pt. Std. SAE	1.732	1.811	2.087	0.882
84818	1-7/8"	6 Pt. Std. SAE	1.732	2.598	2.677	1.543
84819	1-15/16"	6 Pt. Std. SAE	1.732	2.756	2.677	1.830
84820	2"	6 Pt. Std. SAE	1.732	2.795	2.677	1.830
84821	2-1/16"	6 Pt. Std. SAE	2.126	2.874	2.795	2.249
84822	2-1/8"	6 Pt. Std. SAE	2.126	2.953	2.795	2.470
84823	2-3/16"	6 Pt. Std. SAE	2.126	3.031	2.795	2.536
84824	2-1/4"	6 Pt. Std. SAE	2.126	3.150	2.874	2.712
84825	2-5/16"	6 Pt. Std. SAE	2.126	3.150	2.874	2.734
84826	2-3/8"	6 Pt. Std. SAE	2.126	3.268	2.874	2.778
84827	2-7/16"	6 Pt. Std. SAE	2.126	3.268	2.874	2.869
84828	2-1/2"	6 Pt. Std. SAE	2.126	3.268	2.874	2.977
84830	19 mm	6 Pt. Std. Metric	1.732	1.26	1.968	0.728
84831	20 mm	6 Pt. Std. Metric	1.732	1.319	1.968	0.75

IMPACT SOCKETS 3/4" OPEN STOCK

6 Pt. Standard Impact Sockets SAE/METRIC 3/4" DRIVE

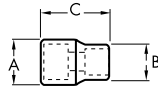

Item No.	Size	Description	Drive End (inch) A	Wrench End (inch) B	Overall Length (inch) C	Weight (lbs)
84832	21 mm	6 Pt. Std. Metric	1.732	1.358	1.968	0.75
84833	22 mm	6 Pt. Std. Metric	1.732	1.402	1.968	0.772
84834	23 mm	6 Pt. Std. Metric	1.732	1.476	1.968	0.772
84835	24 mm	6 Pt. Std. Metric	1.732	1.508	1.968	0.794
84836	25 mm	6 Pt. Std. Metric	1.732	1.575	1.968	0.816
84837	26 mm	6 Pt. Std. Metric	1.732	1.602	1.968	0.838
84838	27 mm	6 Pt. Std. Metric	1.732	1.654	1.968	0.838
84839	28 mm	6 Pt. Std. Metric	1.732	1.732	1.968	0.86
84840	29 mm	6 Pt. Std. Metric	1.732	1.772	2.087	0.882
84841	30 mm	6 Pt. Std. Metric	1.732	1.811	2.087	0.882
84842	31 mm	6 Pt. Std. Metric	1.732	1.89	2.205	0.948
84843	32 mm	6 Pt. Std. Metric	1.732	1.89	2.205	0.992
84844	33 mm	6 Pt. Std. Metric	1.732	1.968	2.205	1.014
84845	34 mm	6 Pt. Std. Metric	1.732	2.008	2.205	1.058
84846	35 mm	6 Pt. Std. Metric	1.732	2.047	2.205	1.102
84847	36 mm	6 Pt. Std. Metric	1.732	2.087	2.205	1.102
84848	37 mm	6 Pt. Std. Metric	1.732	2.165	2.205	1.125
84849	38 mm	6 Pt. Std. Metric	1.732	2.205	2.205	1.147
84850	39 mm	6 Pt. Std. Metric	1.732	2.244	2.205	1.213
84851	40 mm	6 Pt. Std. Metric	1.732	2.323	2.205	1.301
84852	41 mm	6 Pt. Std. Metric	1.732	2.323	2.205	1.433
84853	42 mm	6 Pt. Std. Metric	1.732	2.402	2.205	1.477
84854	43 mm	6 Pt. Std. Metric	1.732	2.402	2.205	1.499
84855	44 mm	6 Pt. Std. Metric	1.732	2.402	2.205	1.499
84856	45 mm	6 Pt. Std. Metric	1.732	2.48	2.205	1.521
84857	46 mm	6 Pt. Std. Metric	1.732	2.598	2.441	1.543
84858	47 mm	6 Pt. Std. Metric	1.732	2.598	2.441	1.566
84859	48 mm	6 Pt. Std. Metric	1.732	2.598	2.441	1.588
84860	49 mm	6 Pt. Std. Metric	1.732	2.598	2.52	1.61
84861	50 mm	6 Pt. Std. Metric	1.732	2.598	2.52	1.654

3/4" OPEN STOCK
IMPACT SOCKETS



6 Pt. Deep Impact Sockets SAE 3/4" DRIVE

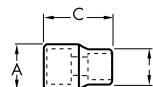

Item No.	Size	Description	Drive End (inch) A	Wrench End (inch) B	Overall Length (inch) C	Weight (lbs)
84863	3/4"	6 Pt. Deep SAE	1.654	1.26	2.008	1.058
84864	13/16"	6 Pt. Deep SAE	1.654	1.378	2.008	1.125
84865	7/8"	6 Pt. Deep SAE	1.654	1.417	2.008	1.213
84866	15/16"	6 Pt. Deep SAE	1.654	1.496	2.008	1.279
84867	1"	6 Pt. Deep SAE	1.654	1.575	2.087	1.345
84868	1-1/16"	6 Pt. Deep SAE	1.732	1.654	2.087	1.389
84869	1-1/8"	6 Pt. Deep SAE	1.732	1.732	2.087	1.433
84870	1-3/16"	6 Pt. Deep SAE	1.732	1.811	2.087	1.543
84871	1-1/4"	6 Pt. Deep SAE	1.732	1.89	2.244	1.632
84872	1-5/16"	6 Pt. Deep SAE	1.732	1.968	2.244	1.676
84873	1-3/8"	6 Pt. Deep SAE	1.732	2.047	3.425	1.852
84874	1-7/16"	6 Pt. Deep SAE	1.732	2.087	2.244	1.852
84875	1-1/2"	6 Pt. Deep SAE	1.732	2.205	2.244	1.94
84876	1-9/16"	6 Pt. Deep SAE	1.732	2.283	2.283	2.007
84877	1-5/8"	6 Pt. Deep SAE	1.732	2.362	2.283	2.095
84878	1-11/16"	6 Pt. Deep SAE	1.732	2.441	2.441	2.183
84879	1-3/4"	6 Pt. Deep SAE	1.732	2.52	2.441	2.293
84880	1-13/16"	6 Pt. Deep SAE	1.732	2.598	2.441	2.381
84881	1-7/8"	6 Pt. Deep SAE	1.732	2.677	2.677	2.646
84882	1-15/16"	6 Pt. Deep SAE	1.732	2.756	2.677	2.69
84883	2"	6 Pt. Deep SAE	1.732	2.795	2.677	2.734

IMPACT SOCKETS 3/4" OPEN STOCK

WRENCHES



Ratcheting Wrenches

Non-Ratcheting Wrenches

**RATCHETING
WRENCHES**

Patented award-winning design

Ratcheting box end needs as little as 5° to move fasteners versus 30° for standard box end wrenches

Surface Drive® box reduces fastener rounding

Flexible Head

Hex head set screw, instead of being pinned

Up to 25% longer to access hard-to-reach fasteners

X-Beam™ allows you to apply force to the flat side of the wrench, reducing hand fatigue

XL X-Beam Flex Ratcheting Wrench™

AVAILABLE IN:

XL Combination	XL X-Beam™	XL Locking Flex	XL Spline	XL GearBox™
Reversible	Flex	Subby Flex	Combination	Stubby
QuadBox™	Double Box	Half Moon	S-Shape	E-Torx®

WRENCHES

RATCHETING WRENCHES

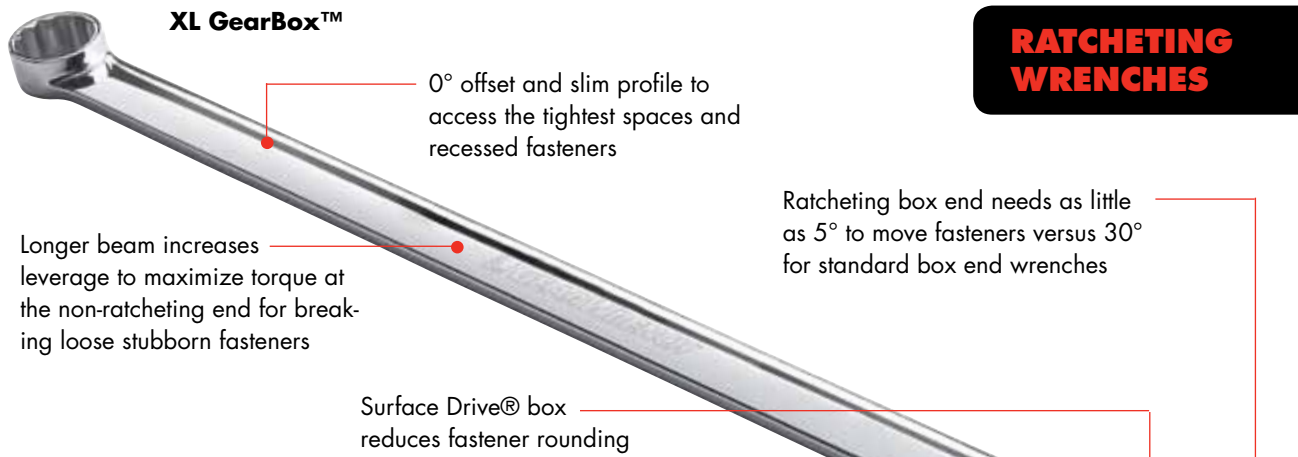

Open Ended Ratcheting Wrench

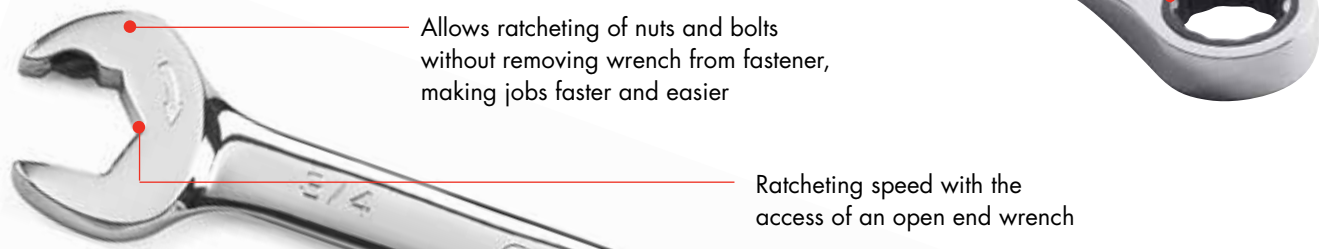

Indexing Ratcheting Wrench

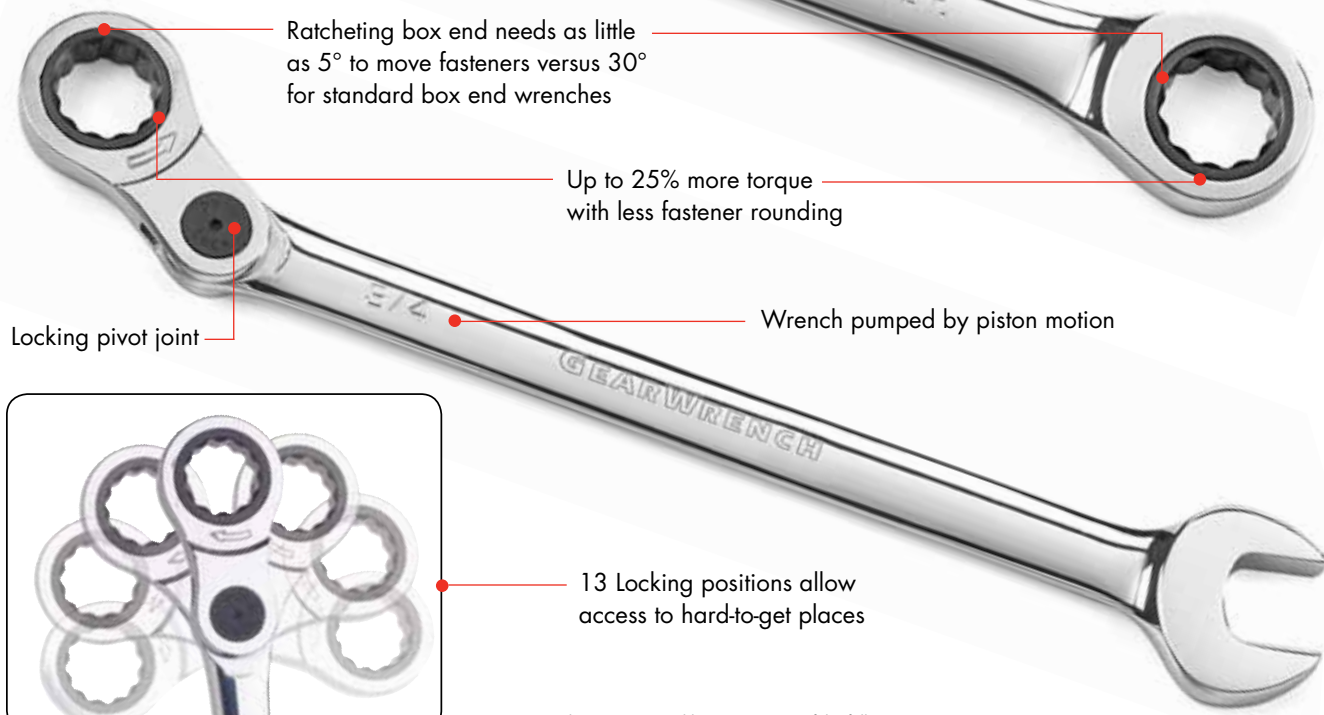

Products are covered by one or more of the following patents:
 • US 5,636,557 US 6,629,477 US 6,918,477 US 7,131,356 US 7,000,507
 US 7,165,480 US 6,868,709 US 7,231,851 US 6,840,141

WRENCHES

XL X-Beam™ *Designed to work with your Hands*



85888 - 12 Pc. XL X-Beam™ Combination Ratcheting Wrench Set METRIC

Item No.	Description	
85808	8 mm	XL X-Beam™ Combination Ratcheting Wrench
85809	9 mm	XL X-Beam™ Combination Ratcheting Wrench
85810	10 mm	XL X-Beam™ Combination Ratcheting Wrench
85811	11 mm	XL X-Beam™ Combination Ratcheting Wrench
85812	12 mm	XL X-Beam™ Combination Ratcheting Wrench
85813	13 mm	XL X-Beam™ Combination Ratcheting Wrench
85814	14 mm	XL X-Beam™ Combination Ratcheting Wrench
85815	15 mm	XL X-Beam™ Combination Ratcheting Wrench
85816	16 mm	XL X-Beam™ Combination Ratcheting Wrench
85817	17 mm	XL X-Beam™ Combination Ratcheting Wrench
85818	18 mm	XL X-Beam™ Combination Ratcheting Wrench
85819	19 mm	XL X-Beam™ Combination Ratcheting Wrench



85898 - 9 Pc. XL X-Beam™ Combination Ratcheting Wrench Set SAE

Item No.	Description	
85850	5/16"	XL X-Beam™ Combination Ratcheting Wrench
85851	11/32"	XL X-Beam™ Combination Ratcheting Wrench
85852	3/8"	XL X-Beam™ Combination Ratcheting Wrench
85854	7/16"	XL X-Beam™ Combination Ratcheting Wrench
85856	1/2"	XL X-Beam™ Combination Ratcheting Wrench
85858	9/16"	XL X-Beam™ Combination Ratcheting Wrench
85860	5/8"	XL X-Beam™ Combination Ratcheting Wrench
85862	11/16"	XL X-Beam™ Combination Ratcheting Wrench
85864	3/4"	XL X-Beam™ Combination Ratcheting Wrench

WRENCHES SETS

XL X-Beam™ *Designed to work with your Hands*

85288 - 12 Pc. XL X-Beam™ Flex Combination Ratcheting Wrench Set METRIC

Item No.	Description
85258	8 mm XL X-Beam™ Flex Combination Ratcheting Wrench
85259	9 mm XL X-Beam™ Flex Combination Ratcheting Wrench
85260	10 mm XL X-Beam™ Flex Combination Ratcheting Wrench
85261	11 mm XL X-Beam™ Flex Combination Ratcheting Wrench
85262	12 mm XL X-Beam™ Flex Combination Ratcheting Wrench
85263	13 mm XL X-Beam™ Flex Combination Ratcheting Wrench
85264	14 mm XL X-Beam™ Flex Combination Ratcheting Wrench
85265	15 mm XL X-Beam™ Flex Combination Ratcheting Wrench
85266	16 mm XL X-Beam™ Flex Combination Ratcheting Wrench
85267	17 mm XL X-Beam™ Flex Combination Ratcheting Wrench
85268	18 mm XL X-Beam™ Flex Combination Ratcheting Wrench
85269	19 mm XL X-Beam™ Flex Combination Ratcheting Wrench



85298 - 9 Pc. XL X-Beam™ Flex Combination Ratcheting Wrench Set SAE

Item No.	Description
85270	5/16" XL X-Beam™ Flex Combination Ratcheting Wrench
85271	11/32" XL X-Beam™ Flex Combination Ratcheting Wrench
85272	3/8" XL X-Beam™ Flex Combination Ratcheting Wrench
85274	7/16" XL X-Beam™ Flex Combination Ratcheting Wrench
85276	1/2" XL X-Beam™ Flex Combination Ratcheting Wrench
85278	9/16" XL X-Beam™ Flex Combination Ratcheting Wrench
85280	5/8" XL X-Beam™ Flex Combination Ratcheting Wrench
85282	11/16" XL X-Beam™ Flex Combination Ratcheting Wrench
85284	3/4" XL X-Beam™ Flex Combination Ratcheting Wrench



SETS
WRENCHES

XL X-Beam™ *Designed to work with your Hands*



85388 - 12 Pc. XL X-Beam™ Reversible Combination Ratcheting Wrench Set METRIC

Item No.	Description
85308	8 mm XL X-Beam™ Reversible Combo Ratcheting Wrench
85309	9 mm XL X-Beam™ Reversible Combo Ratcheting Wrench
85310	10 mm XL X-Beam™ Reversible Combo Ratcheting Wrench
85311	11 mm XL X-Beam™ Reversible Combo Ratcheting Wrench
85312	12 mm XL X-Beam™ Reversible Combo Ratcheting Wrench
85313	13 mm XL X-Beam™ Reversible Combo Ratcheting Wrench
85314	14 mm XL X-Beam™ Reversible Combo Ratcheting Wrench
85315	15 mm XL X-Beam™ Reversible Combo Ratcheting Wrench
85316	16 mm XL X-Beam™ Reversible Combo Ratcheting Wrench
85317	17 mm XL X-Beam™ Reversible Combo Ratcheting Wrench
85318	18 mm XL X-Beam™ Reversible Combo Ratcheting Wrench
85319	19 mm XL X-Beam™ Reversible Combo Ratcheting Wrench



85398 - 9 Pc. XL X-Beam™ Reversible Combination Ratcheting Wrench Set SAE

Item No.	Description
85360	5/16" XL X-Beam™ Reversible Combo Ratcheting
85361	11/32" XL X-Beam™ Reversible Combo Ratcheting
85362	3/8" XL X-Beam™ Reversible Combo Ratcheting
85364	7/16" XL X-Beam™ Reversible Combo Ratcheting
85366	1/2" XL X-Beam™ Reversible Combo Ratcheting
85368	9/16" XL X-Beam™ Reversible Combo Ratcheting
85370	5/8" XL X-Beam™ Reversible Combo Ratcheting
85372	11/16" XL X-Beam™ Reversible Combo Ratcheting
85374	3/4" XL X-Beam™ Reversible Combo Ratcheting

SETS
WRENCHES

XL X-Beam™ *Designed to work with your Hands*

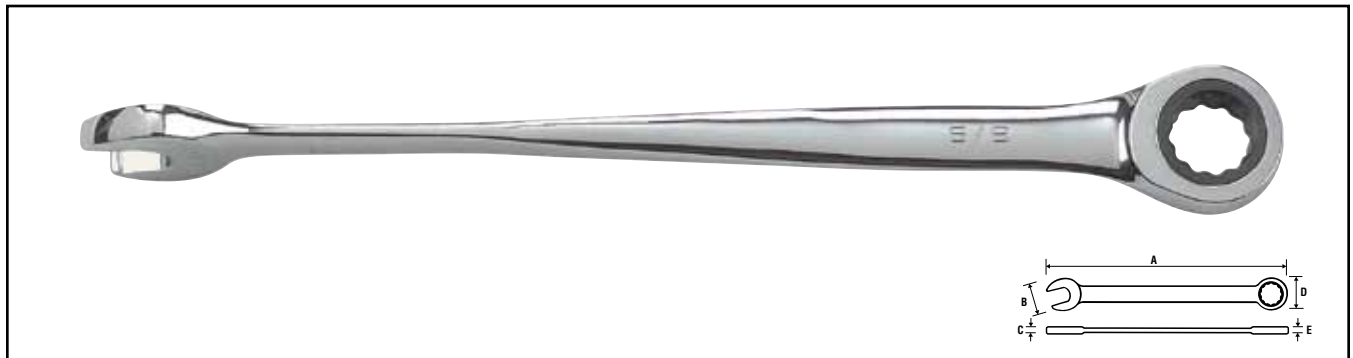

Open Stock - XL X-Beam™ Combination Ratcheting Wrench SAE/METRIC

Item No.	Opening Inches/Metric	Overall Length (inch) A	Width Open End (inch) B	Thickness Open End (inch) C	Width Box End (inch) D	Thickness Box End (inch) E	Weight (lbs)
85850	5/16"	5.910	0.770	0.200	0.670	0.270	0.086
85851	11/32"	6.500	0.770	0.210	0.700	0.270	0.106
85852	3/8"	7.090	0.860	0.220	0.780	0.300	0.121
85854	7/16"	7.680	0.950	0.250	0.850	0.320	0.167
85856	1/2"	8.660	1.150	0.320	0.980	0.340	0.246
85858	9/16"	9.250	1.230	0.330	1.040	0.370	0.290
85860	5/8"	10.240	1.360	0.350	1.200	0.410	0.409
85862	11/16"	10.830	1.490	0.360	1.270	0.420	0.530
85864	3/4"	12.010	1.630	0.370	1.340	0.440	0.642
85808	8 mm	5.910	0.770	0.200	0.670	0.270	0.086
85809	9 mm	6.500	0.770	0.210	0.700	0.270	0.106
85810	10 mm	7.090	0.860	0.220	0.780	0.300	0.121
85811	11 mm	7.680	0.950	0.250	0.850	0.320	0.167
85812	12 mm	8.150	1.050	0.290	0.910	0.340	0.209
85813	13 mm	8.660	1.150	0.320	0.980	0.340	0.246
85814	14 mm	9.250	1.230	0.330	1.040	0.370	0.290
85815	15 mm	9.840	1.330	0.330	1.130	0.390	0.326
85816	16 mm	10.240	1.360	0.350	1.200	0.410	0.409
85817	17 mm	10.830	1.490	0.360	1.270	0.420	0.458
85818	18 mm	11.420	1.580	0.370	1.310	0.440	0.530
85819	19 mm	12.010	1.630	0.370	1.340	0.440	0.642

OPEN STOCK
WRENCHES

XL X-Beam™ *Designed to work with your Hands*

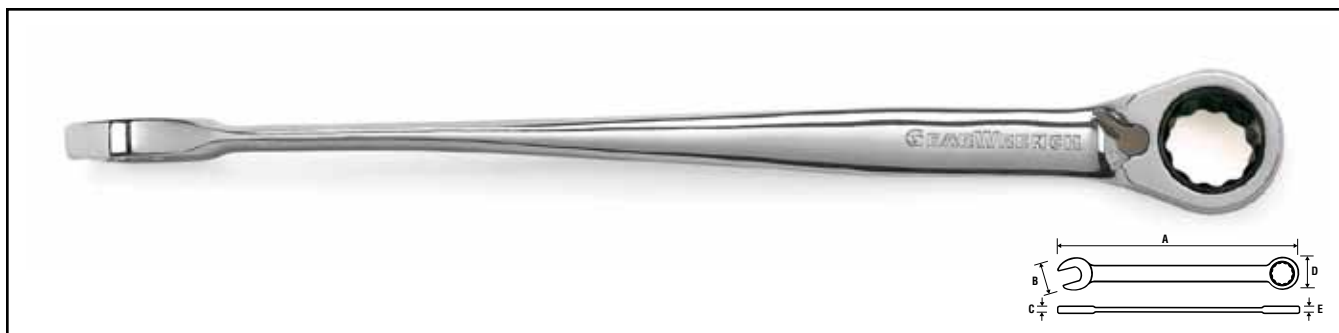

Open Stock - XL X-Beam™ Reversible Combination Ratcheting Wrench SAE/METRIC

Item No.	Opening Inches/Metric	Overall Length (inch) A	Width Open End (inch) B	Thickness Open End (inch) C	Width Box End (inch) D	Thickness Box End (inch) E	Weight (lbs)
85360	5/16"	5.910	0.770	0.200	0.670	0.270	0.084
85361	11/32"	6.500	0.770	0.210	0.700	0.270	0.108
85362	3/8"	7.090	0.860	0.220	0.780	0.300	0.141
85364	7/16"	7.680	0.950	0.250	0.850	0.320	0.187
85366	1/2"	8.660	1.150	0.320	0.980	0.340	0.256
85368	9/16"	9.250	1.230	0.330	1.040	0.370	0.308
85370	5/8"	10.240	1.360	0.350	1.200	0.410	0.449
85372	11/16"	10.830	1.490	0.360	1.270	0.420	0.532
85374	3/4"	12.010	1.630	0.370	1.340	0.440	0.656
85308	8 mm	5.910	0.770	0.20	0.670	0.270	0.084
85309	9 mm	6.500	0.770	0.210	0.700	0.270	0.108
85310	10 mm	7.090	0.860	0.220	0.780	0.300	0.141
85311	11 mm	7.680	0.950	0.250	0.850	0.320	0.187
85312	12 mm	8.150	1.050	0.290	0.910	0.340	0.212
85313	13 mm	8.660	1.150	0.320	0.980	0.340	0.256
85314	14 mm	9.250	1.230	0.330	1.040	0.370	0.308
85315	15 mm	9.840	1.330	0.330	1.130	0.390	0.393
85316	16 mm	10.240	1.360	0.350	1.200	0.410	0.449
85317	17 mm	10.830	1.490	0.360	1.270	0.420	0.532
85318	18 mm	11.420	1.580	0.370	1.310	0.440	0.572
85319	19 mm	12.010	1.630	0.370	1.340	0.440	0.656

PATENTED

OPEN STOCK
WRENCHES

XL X-Beam™ *Designed to work with your Hands*



Open Stock - XL X-Beam™ Flex Combination Ratcheting Wrench SAE/METRIC

Item No.	Opening Inches/Metric	Overall Length (inch) A	Width Open End (inch) B	Thickness Open End (inch) C	Width Box End (inch) D	Thickness Box End (inch) E	Weight (lbs)
85270	5/16"	5.910	0.770	0.200	0.670	0.270	0.110
85271	11/32"	6.500	0.770	0.210	0.700	0.270	0.132
85272	3/8"	7.090	0.860	0.220	0.780	0.300	0.176
85274	7/16"	7.680	0.950	0.250	0.850	0.320	0.220
85276	1/2"	8.660	1.150	0.320	0.980	0.340	0.275
85278	9/16"	9.250	1.230	0.330	1.040	0.370	0.358
85280	5/8"	10.240	1.360	0.350	1.200	0.410	0.484
85282	11/16"	10.830	1.490	0.360	1.270	0.420	0.572
85284	3/4"	12.010	1.630	0.370	1.340	0.440	0.748
85258	8 mm	5.910	0.770	0.200	0.670	0.270	0.110
85259	9 mm	6.500	0.770	0.210	0.700	0.270	0.132
85260	10 mm	7.090	0.860	0.220	0.780	0.300	0.165
85261	11 mm	7.680	0.950	0.250	0.850	0.320	0.209
85262	12 mm	8.150	1.050	0.290	0.910	0.340	0.220
85263	13 mm	8.660	1.150	0.320	0.980	0.340	0.275
85264	14 mm	9.250	1.230	0.330	1.040	0.370	0.352
85265	15 mm	9.840	1.330	0.330	1.130	0.390	0.385
85266	16 mm	10.240	1.360	0.350	1.200	0.410	0.462
85267	17 mm	10.830	1.490	0.360	1.270	0.420	0.563
85268	18 mm	11.420	1.580	0.370	1.310	0.440	0.616
85269	19 mm	12.010	1.630	0.370	1.340	0.440	0.739

OPEN STOCK
WRENCHES

XL Combination *20 percent Longer and 25 percent Stronger*



85099 - 16 Pc. XL Combination Ratcheting Wrench Set METRIC

Item No.	Description	
85008	8 mm	XL Combination Ratcheting Wrench
85009	9 mm	XL Combination Ratcheting Wrench
85010	10 mm	XL Combination Ratcheting Wrench
85011	11 mm	XL Combination Ratcheting Wrench
85012	12 mm	XL Combination Ratcheting Wrench
85013	13 mm	XL Combination Ratcheting Wrench
85014	14 mm	XL Combination Ratcheting Wrench
85015	15 mm	XL Combination Ratcheting Wrench
85016	16 mm	XL Combination Ratcheting Wrench
85017	17 mm	XL Combination Ratcheting Wrench
85018	18 mm	XL Combination Ratcheting Wrench
85019	19 mm	XL Combination Ratcheting Wrench
85020	20 mm	XL Combination Ratcheting Wrench
85021	21 mm	XL Combination Ratcheting Wrench
85022	22 mm	XL Combination Ratcheting Wrench
85024	24 mm	XL Combination Ratcheting Wrench



85099R - 16 Pc. XL Combination Ratcheting Wrench Set METRIC - Wrench Roll

Item No.	Description	
85008	8 mm	XL Combination Ratcheting Wrench
85009	9 mm	XL Combination Ratcheting Wrench
85010	10 mm	XL Combination Ratcheting Wrench
85011	11 mm	XL Combination Ratcheting Wrench
85012	12 mm	XL Combination Ratcheting Wrench
85013	13 mm	XL Combination Ratcheting Wrench
85014	14 mm	XL Combination Ratcheting Wrench
85015	15 mm	XL Combination Ratcheting Wrench
85016	16 mm	XL Combination Ratcheting Wrench
85017	17 mm	XL Combination Ratcheting Wrench
85018	18 mm	XL Combination Ratcheting Wrench
85019	19 mm	XL Combination Ratcheting Wrench
85020	20 mm	XL Combination Ratcheting Wrench
85021	21 mm	XL Combination Ratcheting Wrench
85022	22 mm	XL Combination Ratcheting Wrench
85024	24 mm	XL Combination Ratcheting Wrench

SETS
WRENCHES

XL Combination *20 percent Longer and 25 percent Stronger*

85199 - 13 Pc. XL Combination Ratcheting Wrench Set SAE

Item No.	Description	
85108	1/4"	XL Combination Ratcheting Wrench
85110	5/16"	XL Combination Ratcheting Wrench
85112	3/8"	XL Combination Ratcheting Wrench
85114	7/16"	XL Combination Ratcheting Wrench
85116	1/2"	XL Combination Ratcheting Wrench
85118	9/16"	XL Combination Ratcheting Wrench
85120	5/8"	XL Combination Ratcheting Wrench
85122	11/16"	XL Combination Ratcheting Wrench
85124	3/4"	XL Combination Ratcheting Wrench
85126	13/16"	XL Combination Ratcheting Wrench
85128	7/8"	XL Combination Ratcheting Wrench
85130	15/16"	XL Combination Ratcheting Wrench
85132	1"	XL Combination Ratcheting Wrench



85199R - 13 Pc. XL Combination Ratcheting Wrench Set SAE - Wrench Roll

Item No.	Description	
85108	1/4"	XL Combination Ratcheting Wrench
85110	5/16"	XL Combination Ratcheting Wrench
85112	3/8"	XL Combination Ratcheting Wrench
85114	7/16"	XL Combination Ratcheting Wrench
85116	1/2"	XL Combination Ratcheting Wrench
85118	9/16"	XL Combination Ratcheting Wrench
85120	5/8"	XL Combination Ratcheting Wrench
85122	11/16"	XL Combination Ratcheting Wrench
85124	3/4"	XL Combination Ratcheting Wrench
85126	13/16"	XL Combination Ratcheting Wrench
85128	7/8"	XL Combination Ratcheting Wrench
85130	15/16"	XL Combination Ratcheting Wrench
85132	1"	XL Combination Ratcheting Wrench



SETS
WRENCHES

XL Combination *20 percent Longer and 25 percent Stronger*



85098 - 12 Pc. XL Combination Ratcheting Wrench Set METRIC

Item No.	Description	
85008	8 mm	XL Combination Ratcheting Wrench
85009	9 mm	XL Combination Ratcheting Wrench
85010	10 mm	XL Combination Ratcheting Wrench
85011	11 mm	XL Combination Ratcheting Wrench
85012	12 mm	XL Combination Ratcheting Wrench
85013	13 mm	XL Combination Ratcheting Wrench
85014	14 mm	XL Combination Ratcheting Wrench
85015	15 mm	XL Combination Ratcheting Wrench
85016	16 mm	XL Combination Ratcheting Wrench
85017	17 mm	XL Combination Ratcheting Wrench
85018	18 mm	XL Combination Ratcheting Wrench
85019	19 mm	XL Combination Ratcheting Wrench



85090R - 10 Pc. XL Combination Ratcheting Wrench Set METRIC - Wrench Roll

Item No.	Description	
85010	10 mm	XL Combination Ratcheting Wrench
85011	11 mm	XL Combination Ratcheting Wrench
85012	12 mm	XL Combination Ratcheting Wrench
85013	13 mm	XL Combination Ratcheting Wrench
85014	14 mm	XL Combination Ratcheting Wrench
85015	15 mm	XL Combination Ratcheting Wrench
85016	16 mm	XL Combination Ratcheting Wrench
85017	17 mm	XL Combination Ratcheting Wrench
85018	18 mm	XL Combination Ratcheting Wrench
85019	19 mm	XL Combination Ratcheting Wrench

SETS
WRENCHES

XL Combination *20 percent Longer and 25 percent Stronger*

85198 - 8 Pc. XL Combination Ratcheting Wrench Set SAE

Item No.	Description	
85110	5/16"	XL Combination Ratcheting Wrench
85112	3/8"	XL Combination Ratcheting Wrench
85114	7/16"	XL Combination Ratcheting Wrench
85116	1/2"	XL Combination Ratcheting Wrench
85118	9/16"	XL Combination Ratcheting Wrench
85120	5/8"	XL Combination Ratcheting Wrench
85122	11/16"	XL Combination Ratcheting Wrench
85124	3/4"	XL Combination Ratcheting Wrench



85197R - 7 Pc. XL Combination Ratcheting Wrench Set SAE - Wrench Roll

Item No.	Description	
81152	3/8"	XL Combination Ratcheting Wrench
85114	7/16"	XL Combination Ratcheting Wrench
85116	1/2"	XL Combination Ratcheting Wrench
85118	9/16"	XL Combination Ratcheting Wrench
85120	5/8"	XL Combination Ratcheting Wrench
85122	11/16"	XL Combination Ratcheting Wrench
85124	3/4"	XL Combination Ratcheting Wrench



XL Combination *20 percent Longer and 25 percent Stronger*

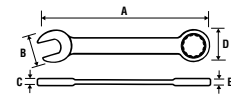

Open Stock - XL Combination Ratcheting Wrench SAE/METRIC

Item No.	Opening Inches/Metric	Overall Length (inch) A	Width Open End (inch) B	Thickness Open End (inch) C	Width Box End (inch) D	Thickness Box End (inch) E	Weight (lbs)
85108	1/4"	5.310	0.570	0.180	0.610	0.260	0.062
85110	5/16"	5.910	0.770	0.200	0.670	0.270	0.088
85112	3/8"	7.090	0.860	0.220	0.780	0.300	0.136
85114	7/16"	7.680	0.950	0.250	0.850	0.320	0.169
85116	1/2"	8.660	1.150	0.320	0.980	0.340	0.251
85118	9/16"	9.250	1.230	0.330	1.040	0.370	0.314
85120	5/8"	10.240	1.360	0.350	1.200	0.410	0.434
85122	11/16"	10.830	1.490	0.360	1.270	0.420	0.488
85124	3/4"	12.010	1.630	0.370	1.340	0.440	0.658
85126	13/16"	12.510	1.770	0.400	1.540	0.510	0.848
85128	7/8"	13.000	1.870	0.420	1.540	0.510	0.952
85130	15/16"	14.000	2.010	0.440	1.750	0.570	1.247
85132	1"	14.500	2.090	0.460	1.750	0.570	1.317
85006	6 mm	5.310	0.570	0.180	0.610	0.260	0.086
85007	7 mm	5.610	0.640	0.190	0.620	0.260	0.087
85008	8 mm	5.910	0.770	0.200	0.670	0.270	0.088
85009	9 mm	6.500	0.770	0.210	0.700	0.270	0.096
85010	10 mm	7.090	0.860	0.220	0.780	0.300	0.136
85011	11 mm	7.680	0.950	0.250	0.850	0.320	0.167
85012	12 mm	8.150	1.050	0.290	0.910	0.340	0.207
85013	13 mm	8.660	1.150	0.320	0.980	0.340	0.234
85014	14 mm	9.250	1.230	0.330	1.040	0.370	0.309
85015	15 mm	9.840	1.330	0.330	1.130	0.390	0.354
85016	16 mm	10.240	1.360	0.350	1.200	0.410	0.430
85017	17 mm	10.830	1.490	0.360	1.270	0.420	0.490
85018	18 mm	11.420	1.580	0.370	1.310	0.440	0.575
85019	19 mm	12.010	1.630	0.370	1.340	0.440	0.669
85020	20 mm	12.510	1.770	0.400	1.540	0.510	0.759
85021	21 mm	12.510	1.770	0.400	1.540	0.510	0.838
85022	22 mm	13.000	1.870	0.420	1.540	0.510	0.954
85024	24 mm	14.000	2.010	0.440	1.750	0.570	1.235

PATENTED

OPEN STOCK
WRENCHES

"Original" Ratcheting Wrench

9416 - 16 Pc. Combination Ratcheting Wrench Set METRIC

Item No.	Description	
9108	8 mm	Combination Ratcheting Wrench
9109	9 mm	Combination Ratcheting Wrench
9110	10 mm	Combination Ratcheting Wrench
9111	11 mm	Combination Ratcheting Wrench
9112	12 mm	Combination Ratcheting Wrench
9113	13 mm	Combination Ratcheting Wrench
9114	14 mm	Combination Ratcheting Wrench
9115	15 mm	Combination Ratcheting Wrench
9116	16 mm	Combination Ratcheting Wrench
9117	17 mm	Combination Ratcheting Wrench
9118	18 mm	Combination Ratcheting Wrench
9119	19 mm	Combination Ratcheting Wrench
9120	20 mm	Combination Ratcheting Wrench
9121	21 mm	Combination Ratcheting Wrench
9122	22 mm	Combination Ratcheting Wrench
9124	24 mm	Combination Ratcheting Wrench

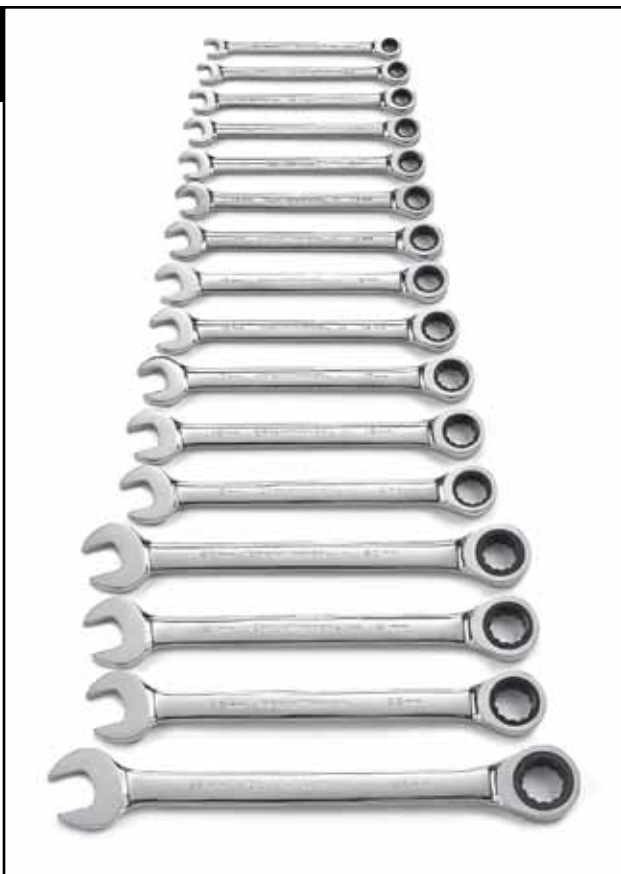

9312 - 13 Pc. Combination Ratcheting Wrench Set SAE

Item No.	Description	
9008	1/4"	Combination Ratcheting Wrench
9010	5/16"	Combination Ratcheting Wrench
9012	3/8"	Combination Ratcheting Wrench
9014	7/16"	Combination Ratcheting Wrench
9016	1/2"	Combination Ratcheting Wrench
9018	9/16"	Combination Ratcheting Wrench
9020	5/8"	Combination Ratcheting Wrench
9022	11/16"	Combination Ratcheting Wrench
9024	3/4"	Combination Ratcheting Wrench
9026	13/16"	Combination Ratcheting Wrench
9028	7/8"	Combination Ratcheting Wrench
9030	15/16"	Combination Ratcheting Wrench
9032	1"	Combination Ratcheting Wrench



SETS
WRENCHES

PATENTED

"Original" Ratcheting Wrench



9412 - 12 Pc. Combination Ratcheting Wrench Set METRIC

Item No.	Description	
9108	8 mm	Combination Ratcheting Wrench
9109	9 mm	Combination Ratcheting Wrench
9110	10 mm	Combination Ratcheting Wrench
9111	11 mm	Combination Ratcheting Wrench
9112	12 mm	Combination Ratcheting Wrench
9113	13 mm	Combination Ratcheting Wrench
9114	14 mm	Combination Ratcheting Wrench
9115	15 mm	Combination Ratcheting Wrench
9116	16 mm	Combination Ratcheting Wrench
9117	17 mm	Combination Ratcheting Wrench
9118	18 mm	Combination Ratcheting Wrench
9119	19 mm	Combination Ratcheting Wrench



9418 - 10 Pc. Combination Ratcheting Wrench Set SAE/METRIC

Item No.	Description	
9010	15/16"	Combination Ratcheting Wrench
9012	3/8"	Combination Ratcheting Wrench
9014	17/16"	Combination Ratcheting Wrench
9016	1/2"	Combination Ratcheting Wrench
9018	9/16"	Combination Ratcheting Wrench
9108	8 mm	Combination Ratcheting Wrench
9110	10 mm	Combination Ratcheting Wrench
9112	12 mm	Combination Ratcheting Wrench
9113	13 mm	Combination Ratcheting Wrench
9114	14 mm	Combination Ratcheting Wrench



9308 - 8 Pc. Combination Ratcheting Wrench Set SAE

Item No.	Description	
9010	15/16"	Combination Ratcheting Wrench
9012	3/8"	Combination Ratcheting Wrench
9014	17/16"	Combination Ratcheting Wrench
9016	1/2"	Combination Ratcheting Wrench
9018	9/16"	Combination Ratcheting Wrench
9020	5/8"	Combination Ratcheting Wrench
9022	11/16"	Combination Ratcheting Wrench
9024	3/4"	Combination Ratcheting Wrench

PATENTED

SETS

WRENCHES

"Original" Ratcheting Wrench

9317 - 7 Pc. Combination Ratcheting Wrench Set SAE

Item No.	Description	
9010	15/16"	Combination Ratcheting Wrench
9012	3/8"	Combination Ratcheting Wrench
9014	17/16"	Combination Ratcheting Wrench
9016	1/2"	Combination Ratcheting Wrench
9018	9/16"	Combination Ratcheting Wrench
9020	5/8"	Combination Ratcheting Wrench
9024	3/4"	Combination Ratcheting Wrench



9417 - 7 Pc. Combination Ratcheting Wrench Set METRIC

Item No.	Description	
9108	8 mm	Combination Ratcheting Wrench
9110	10 mm	Combination Ratcheting Wrench
9112	12 mm	Combination Ratcheting Wrench
9113	13 mm	Combination Ratcheting Wrench
9114	14 mm	Combination Ratcheting Wrench
9115	15 mm	Combination Ratcheting Wrench
9118	18 mm	Combination Ratcheting Wrench



93005 - 5 Pc. Combination Ratcheting Wrench Set SAE

Item No.	Description	
9012	3/8"	Combination Ratcheting Wrench
9014	17/16"	Combination Ratcheting Wrench
9016	1/2"	Combination Ratcheting Wrench
9018	9/16"	Combination Ratcheting Wrench
9020	5/8"	Combination Ratcheting Wrench



9413 - 4 Pc. Combination Ratcheting Wrench Set SAE

Item No.	Description	
9121	21 mm	Combination Ratcheting Wrench
9122	22 mm	Combination Ratcheting Wrench
9124	24 mm	Combination Ratcheting Wrench
9125	25 mm	Combination Ratcheting Wrench



SETS
WRENCHES

PATENTED

"Original" Ratcheting Wrench

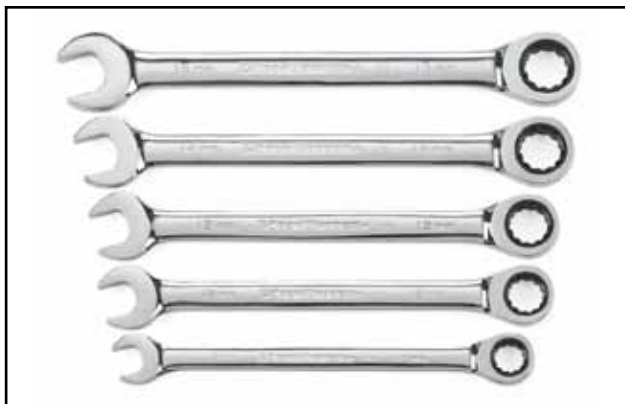

93004 - 5 Pc. Combination Ratcheting Wrench Set METRIC

Item No.	Description	
9110	10 mm	Combination Ratcheting Wrench
9112	12 mm	Combination Ratcheting Wrench
9113	13 mm	Combination Ratcheting Wrench
9114	14 mm	Combination Ratcheting Wrench
9115	15 mm	Combination Ratcheting Wrench



9304 - 4 Pc. Combination Ratcheting Wrench Set SAE

Item No.	Description	
9012	3/8"	Combination Ratcheting Wrench
9014	17/16"	Combination Ratcheting Wrench
9016	1/2"	Combination Ratcheting Wrench
9018	9/16"	Combination Ratcheting Wrench



9404 - 4 Pc. Combination Ratcheting Wrench Set METRIC

Item No.	Description	
9110	10 mm	Combination Ratcheting Wrench
9112	12 mm	Combination Ratcheting Wrench
9113	13 mm	Combination Ratcheting Wrench
9114	14 mm	Combination Ratcheting Wrench



9309 - 4 Pc. Combination Ratcheting Wrench Set SAE

Item No.	Description	
9026	13/16"	Combination Ratcheting Wrench
9028	7/8"	Combination Ratcheting Wrench
9030	15/16"	Combination Ratcheting Wrench
9032	1"	Combination Ratcheting Wrench

PATENTED

SETS

WRENCHES

"Original" Ratcheting Wrench



Open Stock - Combination Ratcheting Wrench SAE

Item No.	Opening Inches/Metric	Overall Length (inch) A	Width Open End (inch) B	Thickness Open End (inch) C	Width Box End (inch) D	Thickness Box End (inch) E	Weight (lbs)
9008	1/4"	4.921	0.567	0.181	0.610	0.256	0.061
9010	5/16"	5.508	0.768	0.197	0.665	0.272	0.073
9011	11/32"	5.882	0.768	0.213	0.701	0.272	0.083
9012	3/8"	6.256	0.862	0.224	0.780	0.303	0.119
9014	7/16"	6.508	0.953	0.252	0.854	0.323	0.145
9016	1/2"	7.008	1.146	0.319	0.984	0.339	0.206
9018	9/16"	7.504	1.228	0.327	1.035	0.370	0.225
9020	5/8"	8.201	1.358	0.346	1.201	0.406	0.313
9022	11/16"	8.878	1.492	0.362	1.272	0.421	0.374
9024	3/4"	9.764	1.626	0.374	1.339	0.441	0.488
9026	13/16"	11.476	1.811	0.390	1.535	0.512	0.739
9028	7/8"	11.476	1.811	0.390	1.535	0.512	0.768
9030	15/16"	13.114	2.055	0.429	1.791	0.571	1.081
9032	1"	13.114	2.055	0.429	1.791	0.571	1.065
9034	1-1/16"	14.142	2.220	0.571	1.929	0.610	1.329
9036	1-1/8"	15.846	2.469	0.492	2.154	0.669	1.972
9038	1-1/4"	16.764	2.634	0.508	2.283	0.689	2.183
9060	1-5/16"	18.110	2.744	0.539	2.362	0.689	2.640
9062	1-3/8"	18.110	2.744	0.539	2.362	0.689	2.640
9040	1-7/16"	19.685	3.114	0.646	2.520	0.807	3.861
9042	1-1/2"	19.685	3.114	0.646	2.520	0.807	3.828
9044	1-9/16"	22.638	3.409	0.709	2.677	0.866	5.183
9046	1-5/8"	22.638	3.409	0.709	2.677	0.866	5.141
9048	1-11/16"	24.213	3.626	0.791	2.835	0.925	5.691
9050	1-3/4"	24.213	3.626	0.791	2.835	0.925	5.641
9052	1-13/16"	25.394	3.850	0.835	2.992	0.984	7.647
9054	1-7/8"	25.394	3.850	0.835	2.992	0.984	7.594
9056	2"	25.787	4.134	0.835	3.150	1.043	8.336

OPEN STOCK
WRENCHES

"Original" Ratcheting Wrench



Open Stock - Combination Ratcheting Wrench METRIC

Item No.	Opening Inches/Metric	Overall Length (inch) A	Width Open End (inch) B	Thickness Open End (inch) C	Width Box End (inch) D	Thickness Box End (inch) E	Weight (lbs)
9106	6 mm	4.921	0.567	0.181	0.610	0.256	0.616
9107	7 mm	5.236	0.642	0.189	0.622	0.256	0.076
9108	8 mm	5.508	0.768	0.197	0.665	0.272	0.073
9109	9 mm	5.882	0.768	0.213	0.701	0.272	0.089
9110	10 mm	6.256	0.862	0.224	0.780	0.303	0.117
9111	11 mm	6.508	0.953	0.252	0.854	0.323	0.135
9112	12 mm	6.756	1.047	0.291	0.906	0.339	1.707
9113	13 mm	7.008	1.146	0.319	0.984	0.339	0.193
9114	14 mm	7.504	1.228	0.327	1.035	0.370	0.236
9115	15 mm	7.854	1.327	0.327	1.130	0.390	0.255
9116	16 mm	8.201	1.358	0.346	1.201	0.406	0.306
9117	17 mm	8.878	1.492	0.362	1.272	0.421	0.376
9118	18 mm	9.311	1.583	0.370	1.307	0.441	0.45
9119	19 mm	9.764	1.626	0.374	1.339	0.441	0.499
9120	20 mm	11.476	1.811	0.390	1.535	0.512	0.78
9121	21 mm	11.476	1.811	0.390	1.535	0.512	0.721
9122	22 mm	11.476	1.811	0.390	1.535	0.512	0.734
9124	24 mm	13.114	2.055	0.429	1.791	0.571	1.074
9125	25 mm	13.114	2.055	0.429	1.791	0.571	1.08
9127	27 mm	14.142	2.220	0.571	1.929	0.610	1.333
9130	30 mm	15.846	2.469	0.492	2.154	0.669	1.849
9132	32 mm	16.764	2.634	0.508	2.283	0.689	2.102
9134	34 mm	18.110	2.744	0.539	2.362	0.689	2.665
9136	36 mm	19.685	3.114	0.646	2.520	0.807	3.874
9141	41 mm	22.638	3.409	0.709	2.677	0.866	5.150
9146	46 mm	25.394	3.850	0.835	2.992	0.984	7.643
9150	50 mm	25.787	4.134	0.835	3.150	1.043	8.369

PATENTED

Stubby Ratcheting Wrench

9520 - 10 Pc. Stubby Combination Ratcheting Wrench Set METRIC

Item No.	Description	
9510	10 mm	Stubby Combination Ratcheting Wrench
9511	11 mm	Stubby Combination Ratcheting Wrench
9512	12 mm	Stubby Combination Ratcheting Wrench
9513	13 mm	Stubby Combination Ratcheting Wrench
9514	14 mm	Stubby Combination Ratcheting Wrench
9515	15 mm	Stubby Combination Ratcheting Wrench
9516	16 mm	Stubby Combination Ratcheting Wrench
9517	17 mm	Stubby Combination Ratcheting Wrench
9518	18 mm	Stubby Combination Ratcheting Wrench
9519	19 mm	Stubby Combination Ratcheting Wrench



9507 - 7 Pc. Stubby Combination Ratcheting Wrench Set SAE

Item No.	Description	
9500	3/8"	Stubby Combination Ratcheting Wrench
9501	7/16"	Stubby Combination Ratcheting Wrench
9502	1/2"	Stubby Combination Ratcheting Wrench
9503	9/16"	Stubby Combination Ratcheting Wrench
9504	5/8"	Stubby Combination Ratcheting Wrench
9505	11/16"	Stubby Combination Ratcheting Wrench
9506	3/4"	Stubby Combination Ratcheting Wrench



SETS
WRENCHES

Stubby Ratcheting Wrench



Open Stock - Stubby Combination Ratcheting Wrench SAE/METRIC

Item No.	Opening Inches/Metric	Overall Length (inch) A	Width Open End (inch) B	Thickness Open End (inch) C	Width Box End (inch) D	Thickness Box End (inch) E	Weight (lbs)
9500	3/8"	3.701	0.862	0.224	0.780	0.303	0.079
9501	7/16"	4.016	0.953	0.252	0.854	0.323	0.914
9502	1/2"	4.213	1.146	0.319	0.984	0.339	1.347
9503	9/16"	4.488	1.228	0.327	1.035	0.370	1.598
9504	5/8"	4.803	1.358	0.346	1.201	0.406	0.214
9505	11/16"	4.961	1.492	0.362	1.272	0.421	0.233
9506	3/4"	5.433	1.626	0.374	1.339	0.441	0.31
9510	10 mm	3.701	0.862	0.224	0.780	0.303	0.073
9511	11 mm	4.016	0.953	0.252	0.854	0.323	0.099
9512	12 mm	4.134	1.047	0.291	0.906	0.339	0.115
9513	13 mm	4.213	1.146	0.319	0.984	0.339	0.128
9514	14 mm	4.488	1.228	0.327	1.035	0.370	0.158
9515	15 mm	4.646	1.327	0.327	1.130	0.390	0.192
9516	16 mm	4.803	1.358	0.346	1.201	0.406	0.207
9517	17 mm	4.961	1.492	0.362	1.272	0.421	0.244
9518	18 mm	5.118	1.583	0.370	1.307	0.441	0.282
9519	19 mm	5.433	1.626	0.374	1.339	0.441	0.316

OPEN STOCK
WRENCHES

Reversible Ratcheting Wrench

9602 - 16 Pc. Reversible Combination Ratcheting Wrench Set METRIC

Item No.	Description	
9608	8 mm	Reversible Combination Ratcheting Wrench
9609	9 mm	Reversible Combination Ratcheting Wrench
9610	10 mm	Reversible Combination Ratcheting Wrench
9611	11 mm	Reversible Combination Ratcheting Wrench
9612	12 mm	Reversible Combination Ratcheting Wrench
9613	13 mm	Reversible Combination Ratcheting Wrench
9614	14 mm	Reversible Combination Ratcheting Wrench
9615	15 mm	Reversible Combination Ratcheting Wrench
9616	16 mm	Reversible Combination Ratcheting Wrench
9617	17 mm	Reversible Combination Ratcheting Wrench
9618	18 mm	Reversible Combination Ratcheting Wrench
9619	19 mm	Reversible Combination Ratcheting Wrench
9621	21 mm	Reversible Combination Ratcheting Wrench
9622	22 mm	Reversible Combination Ratcheting Wrench
9624	24 mm	Reversible Combination Ratcheting Wrench
9625	25 mm	Reversible Combination Ratcheting Wrench



9602R - 16 Pc. Reversible Combination Ratcheting Wrench Set Roll METRIC

Item No.	Description	
9608	8 mm	Reversible Combination Ratcheting Wrench
9609	9 mm	Reversible Combination Ratcheting Wrench
9610	10 mm	Reversible Combination Ratcheting Wrench
9611	11 mm	Reversible Combination Ratcheting Wrench
9612	12 mm	Reversible Combination Ratcheting Wrench
9613	13 mm	Reversible Combination Ratcheting Wrench
9614	14 mm	Reversible Combination Ratcheting Wrench
9615	15 mm	Reversible Combination Ratcheting Wrench
9616	16 mm	Reversible Combination Ratcheting Wrench
9617	17 mm	Reversible Combination Ratcheting Wrench
9618	18 mm	Reversible Combination Ratcheting Wrench
9619	19 mm	Reversible Combination Ratcheting Wrench
9621	21 mm	Reversible Combination Ratcheting Wrench
9622	22 mm	Reversible Combination Ratcheting Wrench
9624	24 mm	Reversible Combination Ratcheting Wrench
9625	25 mm	Reversible Combination Ratcheting Wrench



SETS

WRENCHES

PATENTED

Reversible Ratcheting Wrench



9509 - 13 Pc. Reversible Combination Ratcheting Wrench Set SAE

Item No.	Description
9525	5/16" Reversible Combination Ratcheting Wrench
9521	11/32" Reversible Combination Ratcheting Wrench
9526	3/8" Reversible Combination Ratcheting Wrench
9527	7/16" Reversible Combination Ratcheting Wrench
9528	1/2" Reversible Combination Ratcheting Wrench
9529	9/16" Reversible Combination Ratcheting Wrench
9530	5/8" Reversible Combination Ratcheting Wrench
9531	11/16" Reversible Combination Ratcheting Wrench
9532	3/4" Reversible Combination Ratcheting Wrench
9534	13/16" Reversible Combination Ratcheting Wrench
9538	7/8" Reversible Combination Ratcheting Wrench
9539	15/16" Reversible Combination Ratcheting Wrench
9540	1" Reversible Combination Ratcheting Wrench



9509R - 13 Pc. Reversible Combination Ratcheting Wrench Set Roll SAE

Item No.	Description
9525	5/16" Reversible Combination Ratcheting Wrench
9521	11/32" Reversible Combination Ratcheting Wrench
9526	3/8" Reversible Combination Ratcheting Wrench
9527	7/16" Reversible Combination Ratcheting Wrench
9528	1/2" Reversible Combination Ratcheting Wrench
9529	9/16" Reversible Combination Ratcheting Wrench
9530	5/8" Reversible Combination Ratcheting Wrench
9531	11/16" Reversible Combination Ratcheting Wrench
9532	3/4" Reversible Combination Ratcheting Wrench
9534	13/16" Reversible Combination Ratcheting Wrench
9538	7/8" Reversible Combination Ratcheting Wrench
9539	15/16" Reversible Combination Ratcheting Wrench
9540	1" Reversible Combination Ratcheting Wrench

SETS
WRENCHES

Reversible Ratcheting Wrench

9620 - 12 Pc. Reversible Combination Ratcheting Wrench Set METRIC

Item No.	Description	
9608	8 mm	Reversible Combination Ratcheting Wrench
9609	9 mm	Reversible Combination Ratcheting Wrench
9610	10 mm	Reversible Combination Ratcheting Wrench
9611	11 mm	Reversible Combination Ratcheting Wrench
9612	12 mm	Reversible Combination Ratcheting Wrench
9613	13 mm	Reversible Combination Ratcheting Wrench
9614	14 mm	Reversible Combination Ratcheting Wrench
9615	15 mm	Reversible Combination Ratcheting Wrench
9616	16 mm	Reversible Combination Ratcheting Wrench
9617	17 mm	Reversible Combination Ratcheting Wrench
9618	18 mm	Reversible Combination Ratcheting Wrench
9619	19 mm	Reversible Combination Ratcheting Wrench



9601R - 10 Pc. Reversible Combination Ratcheting Wrench Set Roll METRIC

Item No.	Description	
9610	10 mm	Reversible Combination Ratcheting Wrench
9611	11 mm	Reversible Combination Ratcheting Wrench
9612	12 mm	Reversible Combination Ratcheting Wrench
9613	13 mm	Reversible Combination Ratcheting Wrench
9614	14 mm	Reversible Combination Ratcheting Wrench
9615	15 mm	Reversible Combination Ratcheting Wrench
9616	16 mm	Reversible Combination Ratcheting Wrench
9617	17 mm	Reversible Combination Ratcheting Wrench
9618	18 mm	Reversible Combination Ratcheting Wrench
9619	19 mm	Reversible Combination Ratcheting Wrench



9533 - 8 Pc. Reversible Combination Ratcheting Wrench Set SAE

Item No.	Description	
9525	5/16"	Reversible Combination Ratcheting Wrench
9526	3/8"	Reversible Combination Ratcheting Wrench
9527	7/16"	Reversible Combination Ratcheting Wrench
9528	1/2"	Reversible Combination Ratcheting Wrench
9529	9/16"	Reversible Combination Ratcheting Wrench
9530	5/8"	Reversible Combination Ratcheting Wrench
9531	11/16"	Reversible Combination Ratcheting Wrench
9532	3/4"	Reversible Combination Ratcheting Wrench



PATENTED

SETS
WRENCHES

Reversible Ratcheting Wrench



9567R - 7 Pc. Reversible Combination Ratcheting Wrench Set Roll SAE

Item No.	Description	
9526	3/8"	Reversible Combination Ratcheting Wrench
9527	7/16"	Reversible Combination Ratcheting Wrench
9528	1/2"	Reversible Combination Ratcheting Wrench
9529	9/16"	Reversible Combination Ratcheting Wrench
9530	5/8"	Reversible Combination Ratcheting Wrench
9531	11/16"	Reversible Combination Ratcheting Wrench
9532	3/4"	Reversible Combination Ratcheting Wrench



9543 - 8 Pc. Reversible Combination Ratcheting Wrench Set METRIC

Item No.	Description	
9608	8 mm	Reversible Combination Ratcheting Wrench
9610	10 mm	Reversible Combination Ratcheting Wrench
9612	12 mm	Reversible Combination Ratcheting Wrench
9613	13 mm	Reversible Combination Ratcheting Wrench
9614	14 mm	Reversible Combination Ratcheting Wrench
9615	15 mm	Reversible Combination Ratcheting Wrench
9617	17 mm	Reversible Combination Ratcheting Wrench
9619	19 mm	Reversible Combination Ratcheting Wrench



9545 - 4 Pc. Reversible Combination Ratcheting Wrench Completer Set SAE

Item No.	Description	
9534	13/16"	Reversible Combination Ratcheting Wrench
9538	7/8"	Reversible Combination Ratcheting Wrench
9539	15/16"	Reversible Combination Ratcheting Wrench
9540	1"	Reversible Combination Ratcheting Wrench



9601 - 4 Pc. Reversible Combination Ratcheting Wrench Completer Set METRIC

Item No.	Description	
9621	21 mm	Reversible Combination Ratcheting Wrench
9622	22 mm	Reversible Combination Ratcheting Wrench
9624	24 mm	Reversible Combination Ratcheting Wrench
9625	25 mm	Reversible Combination Ratcheting Wrench

PATENTED

SETS

WRENCHES

Reversible Ratcheting Wrench

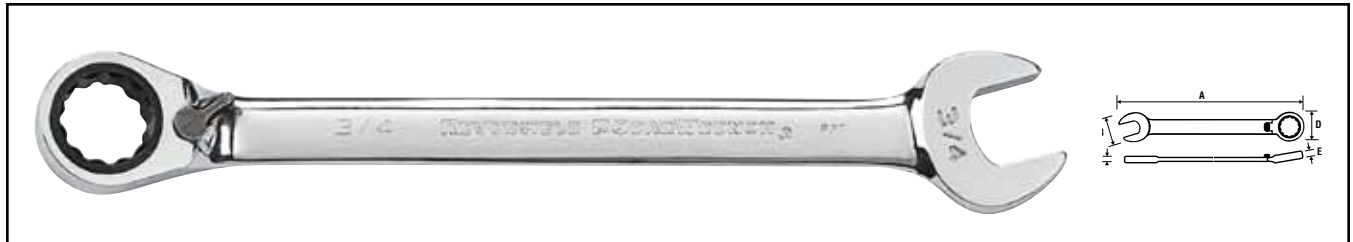

Open Stock - Combination Ratcheting Wrench SAE/METRIC

Item No.	Opening Inches/Metric	Overall Length (inch) A	Width Open End (inch) B	Thickness Open End (inch) C	Width Box End (inch) D	Thickness Box End (inch) E	Weight (lbs)
9525	5/16"	5.433	0.768	0.197	0.665	0.272	0.08
9521	11/32"	5.795	0.768	0.213	0.701	0.272	0.901
9526	3/8"	6.169	0.862	0.224	0.780	0.303	0.137
9527	7/16"	6.413	0.953	0.252	0.854	0.323	0.156
9528	1/2"	6.902	1.146	0.319	0.984	0.339	0.207
9529	9/16"	7.398	1.228	0.327	1.035	0.370	0.242
9530	5/8"	8.087	1.358	0.346	1.201	0.406	0.344
9531	11/16"	8.740	1.492	0.362	1.272	0.421	0.399
9532	3/4"	9.594	1.626	0.374	1.339	0.441	0.536
9534	13/16"	11.476	1.811	0.390	1.535	0.512	0.785
9538	7/8"	11.476	1.811	0.390	1.535	0.512	0.76
9539	15/16"	14.000	2.055	0.429	1.791	0.571	1.174
9540	1"	14.000	2.055	0.429	1.791	0.571	1.317
9608	8 mm	5.433	0.768	0.197	0.665	0.272	0.073
9609	9 mm	5.795	0.768	0.213	0.701	0.272	0.09
9610	10 mm	6.169	0.862	0.224	0.780	0.303	0.115
9611	11 mm	6.413	0.953	0.252	0.854	0.323	0.16
9612	12 mm	6.657	1.047	0.291	0.906	0.339	0.166
9613	13 mm	6.902	1.146	0.319	0.984	0.339	0.193
9614	14 mm	7.398	1.228	0.327	1.035	0.370	0.244
9615	15 mm	7.748	1.327	0.327	1.130	0.390	0.281
9616	16 mm	8.087	1.358	0.346	1.201	0.406	0.35
9617	17 mm	8.740	1.492	0.362	1.272	0.421	0.401
9618	18 mm	9.169	1.583	0.370	1.307	0.441	0.461
9619	19 mm	9.594	1.626	0.374	1.339	0.441	0.536
9621	21 mm	11.476	1.811	0.390	1.535	0.512	0.785
9622	22 mm	11.476	1.811	0.390	1.535	0.512	0.76
9624	24 mm	14.000	2.055	0.429	1.791	0.571	1.174
9625	25 mm	14.000	2.055	0.429	1.791	0.571	1.15

OPEN STOCK
WRENCHES

XL Locking Flex *Ratcheting* Wrench



85698 - 12 Pc. XL Locking Flex Combination Ratcheting Wrench Set METRIC

Item No. Description

85608	8 mm	XL Locking Flex Combination Ratcheting Wrench
85609	9 mm	XL Locking Flex Combination Ratcheting Wrench
85610	10 mm	XL Locking Flex Combination Ratcheting Wrench
85611	11 mm	XL Locking Flex Combination Ratcheting Wrench
85612	12 mm	XL Locking Flex Combination Ratcheting Wrench
85613	13 mm	XL Locking Flex Combination Ratcheting Wrench
85614	14 mm	XL Locking Flex Combination Ratcheting Wrench
85615	15 mm	XL Locking Flex Combination Ratcheting Wrench
85616	16 mm	XL Locking Flex Combination Ratcheting Wrench
85617	17 mm	XL Locking Flex Combination Ratcheting Wrench
85618	18 mm	XL Locking Flex Combination Ratcheting Wrench
85619	19 mm	XL Locking Flex Combination Ratcheting Wrench



85698R - 12 Pc. XL Locking Flex Combination Ratcheting Wrench Set Roll METRIC



85798 - 8 Pc. XL Locking Flex Combination Ratcheting Wrench Set SAE

Item No. Description

85710	5/16"	XL Locking Flex Combination Ratcheting Wrench
85712	3/8"	XL Locking Flex Combination Ratcheting Wrench
85714	7/16"	XL Locking Flex Combination Ratcheting Wrench
85716	1/2"	XL Locking Flex Combination Ratcheting Wrench
85718	9/16"	XL Locking Flex Combination Ratcheting Wrench
85720	5/8"	XL Locking Flex Combination Ratcheting Wrench
85722	11/16"	XL Locking Flex Combination Ratcheting Wrench
85724	3/4"	XL Locking Flex Combination Ratcheting Wrench



85798 - 8 Pc. XL Locking Flex Combination Ratcheting Wrench Set Roll SAE

PATENTED

SETS

WRENCHES

XL Locking Flex Ratcheting Wrench



Open Stock - XL Locking Flex Combination Ratcheting Wrench SAE/METRIC

Item No.	Opening Inches/Metric	Overall Length (inch) A	Width Open End (inch) B	Thickness Open End (inch) C	Width Box End (inch) D	Thickness Box End (inch) E	Weight (lbs)
85710	5/16"	5.750	0.770	0.980	0.670	0.270	0.090
85712	3/8"	6.730	0.860	1.040	0.780	0.300	0.150
85714	7/16"	7.200	0.950	0.250	0.850	0.320	0.180
85716	1/2"	8.150	1.150	0.320	0.980	0.340	0.260
85718	9/16"	8.620	1.230	0.670	1.040	0.370	0.320
85720	5/8"	9.530	1.360	0.700	1.200	0.410	0.440
85722	11/16"	10.00	1.490	0.780	1.270	0.420	0.500
85724	3/4"	11.020	1.630	0.850	1.340	0.440	0.660
85608	8 mm	5.750	0.770	0.200	0.670	0.270	0.090
85609	9 mm	6.260	0.770	0.210	0.700	0.270	0.110
85610	10 mm	6.730	0.860	0.220	0.780	0.300	0.150
85611	11 mm	7.200	0.950	0.250	0.850	0.320	0.180
85612	12 mm	7.680	1.050	0.290	0.910	0.340	0.220
85613	13 mm	8.150	1.150	0.320	0.980	0.340	0.260
85614	14 mm	8.620	1.230	0.330	1.040	0.370	0.320
85615	15 mm	9.090	1.330	0.330	1.130	0.390	0.360
85616	16 mm	9.530	1.360	0.350	1.200	0.410	0.440
85617	17 mm	10.00	1.490	0.360	1.270	0.420	0.500
85618	18 mm	10.510	1.580	0.370	1.310	0.440	0.560
85619	19 mm	11.020	1.630	0.370	1.340	0.440	0.660

OPEN STOCK

WRENCHES

XL Locking Flex Ratcheting Wrench



9902 - 16 Pc. Flex Combination Ratcheting Wrench Set METRIC

Item No.	Description	
9908	8 mm	Flex Combination Ratcheting Wrench
9909	9 mm	Flex Combination Ratcheting Wrench
9910	10 mm	Flex Combination Ratcheting Wrench
9911	11 mm	Flex Combination Ratcheting Wrench
9912	12 mm	Flex Combination Ratcheting Wrench
9913	13 mm	Flex Combination Ratcheting Wrench
9914	14 mm	Flex Combination Ratcheting Wrench
9915	15 mm	Flex Combination Ratcheting Wrench
9916	16 mm	Flex Combination Ratcheting Wrench
9917	17 mm	Flex Combination Ratcheting Wrench
9918	18 mm	Flex Combination Ratcheting Wrench
9919	19 mm	Flex Combination Ratcheting Wrench
9921	21 mm	Flex Combination Ratcheting Wrench
9922	22 mm	Flex Combination Ratcheting Wrench
9924	24 mm	Flex Combination Ratcheting Wrench
9925	25 mm	Flex Combination Ratcheting Wrench



9702 - 13 Pc. Flex Combination Ratcheting Wrench Set SAE

Item No.	Description	
9705	5/16"	Flex Combination Ratcheting Wrench
9704	11/32"	Flex Combination Ratcheting Wrench
9706	3/8"	Flex Combination Ratcheting Wrench
9707	7/16"	Flex Combination Ratcheting Wrench
9708	1/2"	Flex Combination Ratcheting Wrench
9709	9/16"	Flex Combination Ratcheting Wrench
9710	5/8"	Flex Combination Ratcheting Wrench
9711	11/16"	Flex Combination Ratcheting Wrench
9712	3/4"	Flex Combination Ratcheting Wrench
9713	13/16"	Flex Combination Ratcheting Wrench
9714	7/8"	Flex Combination Ratcheting Wrench
9715	15/16"	Flex Combination Ratcheting Wrench
9716	1"	Flex Combination Ratcheting Wrench

SETS
WRENCHES

Flex Ratcheting Wrench

9901 - 12 Pc. Flex Combination Ratcheting Wrench Set METRIC

Item No.	Description	
9908	8 mm	Flex Combination Ratcheting Wrench
9909	9 mm	Flex Combination Ratcheting Wrench
9910	10 mm	Flex Combination Ratcheting Wrench
9911	11 mm	Flex Combination Ratcheting Wrench
9912	12 mm	Flex Combination Ratcheting Wrench
9913	13 mm	Flex Combination Ratcheting Wrench
9914	14 mm	Flex Combination Ratcheting Wrench
9915	15 mm	Flex Combination Ratcheting Wrench
9916	16 mm	Flex Combination Ratcheting Wrench
9917	17 mm	Flex Combination Ratcheting Wrench
9918	18 mm	Flex Combination Ratcheting Wrench
9919	19 mm	Flex Combination Ratcheting Wrench



9701 - 8 Pc. Flex Combination Ratcheting Wrench Set SAE

Item No.	Description	
9705	5/16"	Flex Combination Ratcheting Wrench
9706	3/8"	Flex Combination Ratcheting Wrench
9707	7/16"	Flex Combination Ratcheting Wrench
9708	1/2"	Flex Combination Ratcheting Wrench
9709	9/16"	Flex Combination Ratcheting Wrench
9710	5/8"	Flex Combination Ratcheting Wrench
9711	11/16"	Flex Combination Ratcheting Wrench
9712	3/4"	Flex Combination Ratcheting Wrench



9700 - 7 Pc. Flex Combination Ratcheting Wrench Set SAE

Item No.	Description	
9706	3/8"	Flex Combination Ratcheting Wrench
9707	7/16"	Flex Combination Ratcheting Wrench
9708	1/2"	Flex Combination Ratcheting Wrench
9709	9/16"	Flex Combination Ratcheting Wrench
9710	5/8"	Flex Combination Ratcheting Wrench
9711	11/16"	Flex Combination Ratcheting Wrench
9712	3/4"	Flex Combination Ratcheting Wrench



SETS
WRENCHES

PATENTED

Flex Ratcheting Wrench



9900 - 7 Pc. Flex Combination Ratcheting Wrench Set METRIC

Item No.	Description	
9910	10 mm	Flex Combination Ratcheting Wrench
9912	12 mm	Flex Combination Ratcheting Wrench
9913	13 mm	Flex Combination Ratcheting Wrench
9914	14 mm	Flex Combination Ratcheting Wrench
9915	15 mm	Flex Combination Ratcheting Wrench
9917	17 mm	Flex Combination Ratcheting Wrench
9919	19 mm	Flex Combination Ratcheting Wrench



9703 - 4 Pc. Flex Combination Ratcheting Wrench Completer Set SAE

Item No.	Description	
9713	13/16"	Flex Combination Ratcheting Wrench
9714	7/8"	Flex Combination Ratcheting Wrench
9715	15/16"	Flex Combination Ratcheting Wrench
9716	1"	Flex Combination Ratcheting Wrench



9903 - 4 Pc. Flex Combination Ratcheting Wrench Completer Set METRIC

Item No.	Description	
9921	21 mm	Flex Combination Ratcheting Wrench
9922	22 mm	Flex Combination Ratcheting Wrench
9924	24 mm	Flex Combination Ratcheting Wrench
9925	25 mm	Flex Combination Ratcheting Wrench

PATENTED

SETS
WRENCHES

Flex Ratcheting Wrench



Open Stock - Flex Combination Ratcheting Wrench SAE/METRIC

Item No.	Opening Inches/Metric	Overall Length (inch) A	Width Open End (inch) B	Thickness Open End (inch) C	Width Box End (inch) D	Thickness Box End (inch) E	Weight (lbs)
9704	11/32"	5.882	0.768	0.213	0.701	0.272	0.11
9705	5/16"	5.508	0.768	0.197	0.665	0.272	0.087
9706	3/8"	6.252	0.862	0.224	0.780	0.303	0.138
9707	7/16"	6.504	0.953	0.252	0.854	0.323	0.168
9708	1/2"	7.004	1.146	0.319	0.984	0.339	0.238
9709	9/16"	7.504	1.228	0.327	1.035	0.370	0.282
9710	5/8"	8.197	1.358	0.346	1.201	0.406	0.383
9711	11/16"	8.878	1.492	0.362	1.272	0.421	0.448
9712	3/4"	9.764	1.626	0.374	1.339	0.441	0.588
9713	13/16"	11.476	1.811	0.390	1.535	0.512	0.9
9714	7/8"	11.476	1.811	0.390	1.535	0.512	0.864
9715	15/16"	13.114	2.055	0.429	1.791	0.571	1.316
9716	1"	13.114	2.055	0.429	1.791	0.571	1.292
9908	8 mm	5.508	0.768	0.197	0.665	0.272	0.086
9909	9 mm	5.882	0.768	0.213	0.701	0.272	0.103
9910	10 mm	6.252	0.862	0.224	0.780	0.303	0.138
9911	11 mm	6.504	0.953	0.252	0.854	0.323	0.162
9912	12 mm	6.756	1.047	0.291	0.906	0.339	0.197
9913	13 mm	7.004	1.146	0.319	0.984	0.339	0.238
9914	14 mm	7.504	1.228	0.327	1.035	0.370	0.279
9915	15 mm	7.854	1.327	0.327	1.130	0.390	0.334
9916	16 mm	8.197	1.358	0.346	1.201	0.406	0.383
9917	17 mm	8.878	1.492	0.362	1.272	0.421	0.451
9918	18 mm	9.315	1.583	0.370	1.307	0.441	0.517
9919	19 mm	9.764	1.626	0.374	1.339	0.441	0.59
9921	21 mm	11.476	1.811	0.390	1.535	0.512	0.886
9922	22 mm	11.476	1.811	0.390	1.535	0.512	0.868
9924	24 mm	13.114	2.055	0.429	1.791	0.571	1.31
9925	25 mm	14.000	2.055	0.429	1.791	0.571	1.15

OPEN STOCK
WRENCHES

Stubby Flex *Ratcheting Wrench*



9550 - 10 Pc. Stubby Flex Combination Ratcheting Wrench Set **METRIC**

Item No.	Description	
9551	10 mm	Stubby Flex Combination Ratcheting Wrench
9552	11 mm	Stubby Flex Combination Ratcheting Wrench
9553	12 mm	Stubby Flex Combination Ratcheting Wrench
9554	13 mm	Stubby Flex Combination Ratcheting Wrench
9555	14 mm	Stubby Flex Combination Ratcheting Wrench
9556	15 mm	Stubby Flex Combination Ratcheting Wrench
9557	16 mm	Stubby Flex Combination Ratcheting Wrench
9558	17 mm	Stubby Flex Combination Ratcheting Wrench
9559	18 mm	Stubby Flex Combination Ratcheting Wrench
9560	19 mm	Stubby Flex Combination Ratcheting Wrench

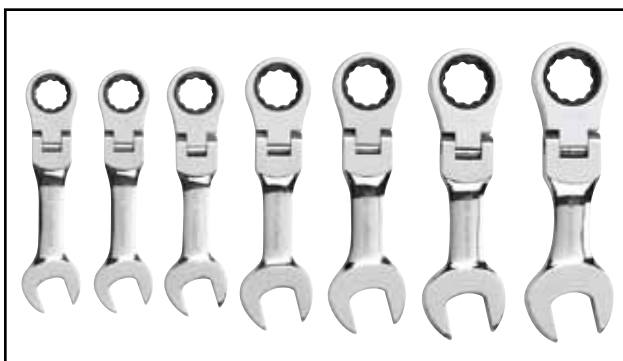

9570 - 7 Pc. Stubby Flex Combination Ratcheting Wrench Set **SAE**

Item No.	Description	
9571	3/8"	Stubby Flex Combination Ratcheting Wrench
9572	7/16"	Stubby Flex Combination Ratcheting Wrench
9573	1/2"	Stubby Flex Combination Ratcheting Wrench
9574	9/16"	Stubby Flex Combination Ratcheting Wrench
9575	5/8"	Stubby Flex Combination Ratcheting Wrench
9576	11/16"	Stubby Flex Combination Ratcheting Wrench
9577	3/4"	Stubby Flex Combination Ratcheting Wrench

Stubby Flex Ratcheting Wrench

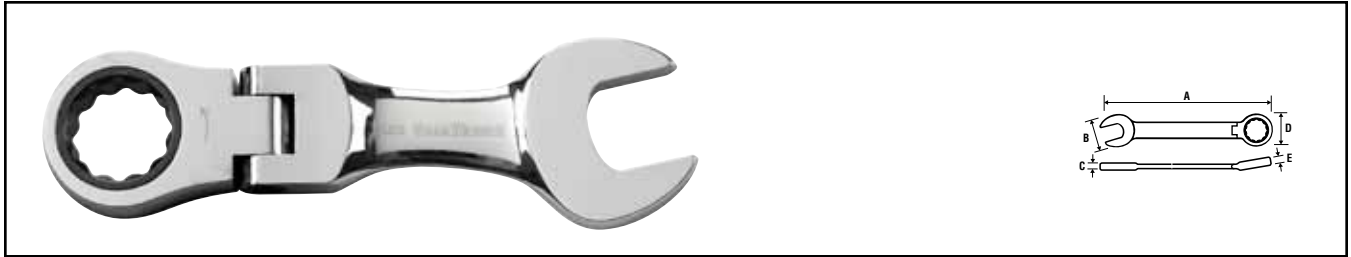

Open Stock - Stubby Flex Combination Ratcheting Wrench SAE

Item No.	Opening Inches/Metric	Overall Length (inch) A	Width Open End (inch) B	Thickness Open End (inch) C	Width Box End (inch) D	Thickness Box End (inch) E	Weight (lbs)
9571	3/8"	3.701	0.862	0.224	0.780	0.303	0.101
9572	7/16"	4.016	0.953	0.252	0.854	0.323	0.121
9573	1/2"	4.213	1.146	0.319	0.984	0.339	0.167
9574	9/16"	4.488	1.228	0.327	1.035	0.370	0.203
9575	5/8"	4.803	1.358	0.346	1.201	0.406	0.268
9576	11/16"	4.961	1.492	0.362	1.272	0.421	0.308
9577	3/4"	5.433	1.626	0.374	1.339	0.441	0.41
9551	10 mm	3.701	0.862	0.224	0.780	0.303	0.102
9552	11 mm	4.016	0.953	0.252	0.854	0.323	0.12
9553	12 mm	4.134	1.047	0.291	0.906	0.339	0.144
9554	13 mm	4.213	1.146	0.319	0.984	0.339	0.167
9555	14 mm	4.488	1.228	0.327	1.035	0.370	0.202
9556	15 mm	4.646	1.327	0.327	1.130	0.390	0.232
9557	16 mm	4.803	1.358	0.346	1.201	0.406	0.268
9558	17 mm	4.961	1.492	0.362	1.272	0.421	0.314
9559	18 mm	5.118	1.583	0.370	1.307	0.441	0.361
9560	19 mm	5.433	1.626	0.374	1.339	0.441	0.408

OPEN STOCK

WRENCHES

XL GearBox™ Ratcheting Wrenches



85988 - 12 Pc. XL GearBox™ Double Box Ratcheting Wrench Set METRIC

Item No.	Description	
85908	8 mm	XL GearBox™ Double Box Ratcheting Wrench
85909	9 mm	XL GearBox™ Double Box Ratcheting Wrench
85910	10 mm	XL GearBox™ Double Box Ratcheting Wrench
85911	11 mm	XL GearBox™ Double Box Ratcheting Wrench
85912	12 mm	XL GearBox™ Double Box Ratcheting Wrench
85913	13 mm	XL GearBox™ Double Box Ratcheting Wrench
85914	14 mm	XL GearBox™ Double Box Ratcheting Wrench
85915	15 mm	XL GearBox™ Double Box Ratcheting Wrench
85916	16 mm	XL GearBox™ Double Box Ratcheting Wrench

85917	17 mm	XL GearBox™ Double Box Ratcheting Wrench
85918	18 mm	XL GearBox™ Double Box Ratcheting Wrench
85919	19 mm	XL GearBox™ Double Box Ratcheting Wrench



85989 - 17 Pc. XL GearBox™ Double Box Ratcheting Wrench Set METRIC

Item No.	Description	
85908	8 mm	XL GearBox™ Ratcheting Wrench
85909	9 mm	XL GearBox™ Ratcheting Wrench
85910	10 mm	XL GearBox™ Ratcheting Wrench
85911	11 mm	XL GearBox™ Ratcheting Wrench
85912	12 mm	XL GearBox™ Ratcheting Wrench
85913	13 mm	XL GearBox™ Ratcheting Wrench
85914	14 mm	XL GearBox™ Ratcheting Wrench
85915	15 mm	XL GearBox™ Ratcheting Wrench
85916	16 mm	XL GearBox™ Ratcheting Wrench
85917	17 mm	XL GearBox™ Ratcheting Wrench
85918	18 mm	XL GearBox™ Ratcheting Wrench
85919	19 mm	XL GearBox™ Ratcheting Wrench

MASTER SET

85920	20 mm	XL GearBox™ Ratcheting Wrench
85921	21 mm	XL GearBox™ Ratcheting Wrench
85922	22 mm	XL GearBox™ Ratcheting Wrench
85924	24 mm	XL GearBox™ Ratcheting Wrench
85925	25 mm	XL GearBox™ Ratcheting Wrench



85987 - 5 Pc. XL GearBox™ Double Box Ratcheting Wrench Add-On Set METRIC

Item No.	Description	
85920	20 mm	XL GearBox™ Ratcheting Wrench
85921	21 mm	XL GearBox™ Ratcheting Wrench
85922	22 mm	XL GearBox™ Ratcheting Wrench
85924	24 mm	XL GearBox™ Ratcheting Wrench
85925	25 mm	XL GearBox™ Ratcheting Wrench

ADD-ON SET (Complement to 85988)

PATENTED

XL GearBox™ Ratcheting Wrenches

85999 - 13 Pc. XL GearBox™ Double Box Ratcheting Wrench Set SAE

Item No.	Description	
85950	5/16"	XL GearBox™ Ratcheting Wrench
85951	11/32"	XL GearBox™ Ratcheting Wrench
85952	3/8"	XL GearBox™ Ratcheting Wrench
85954	7/16"	XL GearBox™ Ratcheting Wrench
85956	1/2"	XL GearBox™ Ratcheting Wrench
85958	9/16"	XL GearBox™ Ratcheting Wrench
85960	5/8"	XL GearBox™ Ratcheting Wrench
85962	11/16"	XL GearBox™ Ratcheting Wrench
85964	3/4"	XL GearBox™ Ratcheting Wrench
85966	13/16"	XL GearBox™ Ratcheting Wrench
85968	7/8"	XL GearBox™ Ratcheting Wrench
85970	15/16"	XL GearBox™ Ratcheting Wrench
85972	1"	XL GearBox™ Ratcheting Wrench



MASTER SET

85998 - 9 Pc. XL GearBox™ Double Box Ratcheting Wrench Set SAE

Item No.	Description	
85950	5/16"	XL GearBox™ Double Box Ratcheting Wrench
85951	11/32"	XL GearBox™ Double Box Ratcheting Wrench
85952	3/8"	XL GearBox™ Double Box Ratcheting Wrench
85954	7/16"	XL GearBox™ Double Box Ratcheting Wrench
85956	1/2"	XL GearBox™ Double Box Ratcheting Wrench
85958	9/16"	XL GearBox™ Double Box Ratcheting Wrench
85960	5/8"	XL GearBox™ Double Box Ratcheting Wrench
85962	11/16"	XL GearBox™ Double Box Ratcheting Wrench
85964	3/4"	XL GearBox™ Double Box Ratcheting Wrench



85996 - 4 Pc. XL GearBox™ Double Box Ratcheting Wrench Add-On Set SAE

Item No.	Description	
85966	13/16"	XL GearBox™ Ratcheting Wrench
85968	7/8"	XL GearBox™ Ratcheting Wrench
85970	15/16"	XL GearBox™ Ratcheting Wrench
85972	1"	XL GearBox™ Ratcheting Wrench



ADD-ON SET (Complement to 85998)

SETS
WRENCHES

PATENTED

XL GearBox™ Ratcheting Wrenches



Open Stock - XL GearBox™ Double Box Ratcheting Wrench SAE/METRIC

Item No.	Opening Inches/Metric	Overall Length (inch) A	Width Box End (inch) B	Thickness Box End (inch) C	Width Box End (inch) D	Thickness Box End (inch) E	Weight (lbs)
85950	5/16"	8.71	0.67	0.27	0.46	0.24	0.121
85951	11/32"	8.91	0.7	0.27	0.52	0.26	0.125
85952	3/8"	9.5	0.78	0.3	0.57	0.27	0.167
85954	7/16"	9.89	0.85	0.32	0.62	0.31	0.196
85956	1/2"	11.31	0.98	0.34	0.74	0.35	0.260
85958	9/16"	12.02	1.04	0.37	0.8	0.39	0.378
85960	5/8"	13.71	1.2	0.41	0.9	0.43	0.497
85962	11/16"	14.7	1.27	0.42	0.94	0.43	0.667
85964	3/4"	15.6	1.34	0.44	1.04	0.47	0.768
85966	13/16"	16.54	1.54	0.51	1.18	0.57	1.415
85968	7/8"	17.01	1.54	0.51	1.22	0.57	2.062
85970	15/16"	18.03	1.75	0.57	1.34	0.59	2.709
85972	1"	18.5	1.75	0.57	1.42	0.59	3.356
85908	8 mm	8.71	0.67	0.27	0.46	0.24	0.121
85909	9 mm	8.91	0.7	0.27	0.52	0.26	0.125
85910	10 mm	9.5	0.78	0.3	0.57	0.27	0.167
85911	11 mm	9.89	0.85	0.32	0.62	0.31	0.196
85912	12 mm	10.52	0.91	0.34	0.68	0.33	0.260
85913	13 mm	11.31	0.98	0.34	0.74	0.35	0.330
85914	14 mm	12.02	1.04	0.37	0.8	0.39	0.378
85915	15 mm	12.72	1.13	0.39	0.86	0.43	0.462
85916	16 mm	13.71	1.2	0.41	0.9	0.43	0.497
85917	17 mm	14.7	1.27	0.42	0.94	0.43	0.667
85918	18 mm	15.13	1.31	0.44	0.98	0.45	0.691
85919	19 mm	15.6	1.34	0.44	1.04	0.47	0.768
85920	20 mm	15.98	1.54	0.51	1.14	0.52	1.415
85921	21 mm	16.54	1.54	0.51	1.18	0.57	2.062
85922	22 mm	17.01	1.54	0.51	1.22	0.57	2.709
85924	24 mm	18.03	1.75	0.57	1.34	0.59	3.356
85925	25 mm	18.5	1.75	0.57	1.42	0.59	4.003

PATENTED

OPEN STOCK
WRENCHES

XL Spline Ratcheting Wrenches

85598 - 9 Pc. XL Spline Combination Ratcheting Wrench Set SAE

Item No.	Description
85548	#8 x 1/4" XL Spline Combination Ratcheting Wrench
85550	#10 x 5/16" XL Spline Combination Ratcheting Wrench
85552	#12 x 3/8" XL Spline Combination Ratcheting Wrench
85554	#14 x 7/16" XL Spline Combination Ratcheting Wrench
85556	#16 x 1/2" XL Spline Combination Ratcheting Wrench
85558	#18 x 9/16" XL Spline Combination Ratcheting Wrench
85560	#20 x 5/8" XL Spline Combination Ratcheting Wrench
85562	#22 x 11/16" XL Spline Combination Ratcheting Wrench
85564	#24 x 3/4" XL Spline Combination Ratcheting Wrench



Open Stock - XL Spline Combination Ratcheting Wrench SAE

Item No.	Opening Inches	Overall Length (inch) A	Width Open End (inch) B	Thickness Open End (inch) C	Width Box End (inch) D	Thickness Box End (inch) E	Weight (lbs)
85548	#8 x 1/4"	5.315	0.610	0.256	0.567	0.181	0.121
85550	#10 x 5/16"	5.906	0.665	0.272	0.768	0.197	0.196
85552	#12 x 3/8"	7.087	0.780	0.303	0.862	0.224	0.227
85554	#14 x 7/16"	7.677	0.854	0.323	0.953	0.252	0.296
85556	#16 x 1/2"	8.661	0.984	0.339	1.146	0.319	0.347
85558	#18 x 9/16"	9.252	1.035	0.370	1.228	0.327	0.385
85560	#20 x 5/8"	10.236	1.201	0.406	1.358	0.346	0.517
85562	#22 x 11/16"	10.827	1.272	0.421	1.492	0.362	0.577
85564	#24 x 3/4"	12.008	1.339	0.441	1.626	0.374	0.771

SETS

WRENCHES

Indexing *Ratcheting Wrenches*

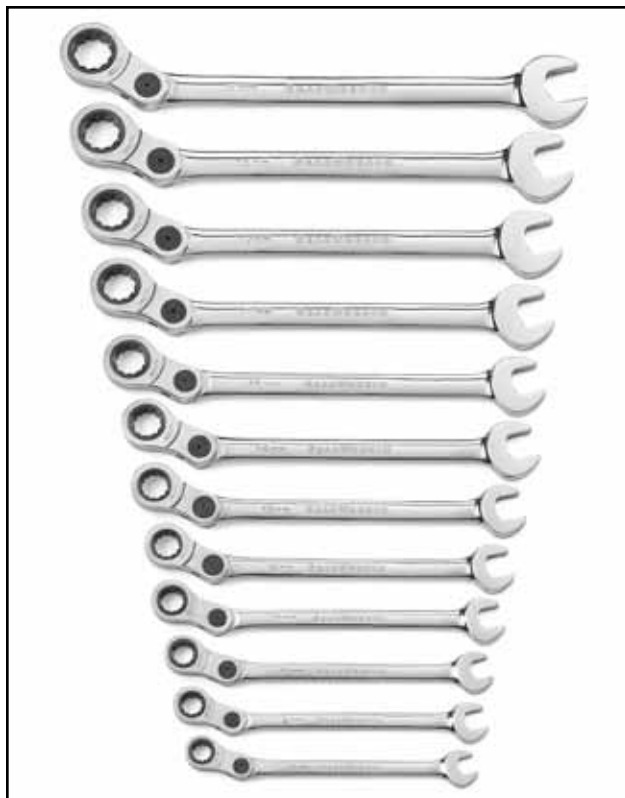

85488 - 12 Pc. Indexing Combination Wrench Set METRIC

Item No.	Description	
85418	8 mm	Indexing Combination Wrench
85439	9 mm	Indexing Combination Wrench
85440	10 mm	Indexing Combination Wrench
85441	11 mm	Indexing Combination Wrench
85442	12 mm	Indexing Combination Wrench
85443	13 mm	Indexing Combination Wrench
85444	14 mm	Indexing Combination Wrench
85445	15 mm	Indexing Combination Wrench
85446	16 mm	Indexing Combination Wrench
85447	17 mm	Indexing Combination Wrench
85448	18 mm	Indexing Combination Wrench
85449	19 mm	Indexing Combination Wrench



85498 - 8 Pc. Indexing Combination Wrench Set SAE

Item No.	Description	
85450	5/16"	Indexing Combination Wrench
85452	3/8"	Indexing Combination Wrench
85454	7/16"	Indexing Combination Wrench
85456	1/2"	Indexing Combination Wrench
85458	9/16"	Indexing Combination Wrench
85460	5/8"	Indexing Combination Wrench
85462	11/16"	Indexing Combination Wrench
85464	3/4"	Indexing Combination Wrench

SETS
WRENCHES

Indexing Ratcheting Wrenches

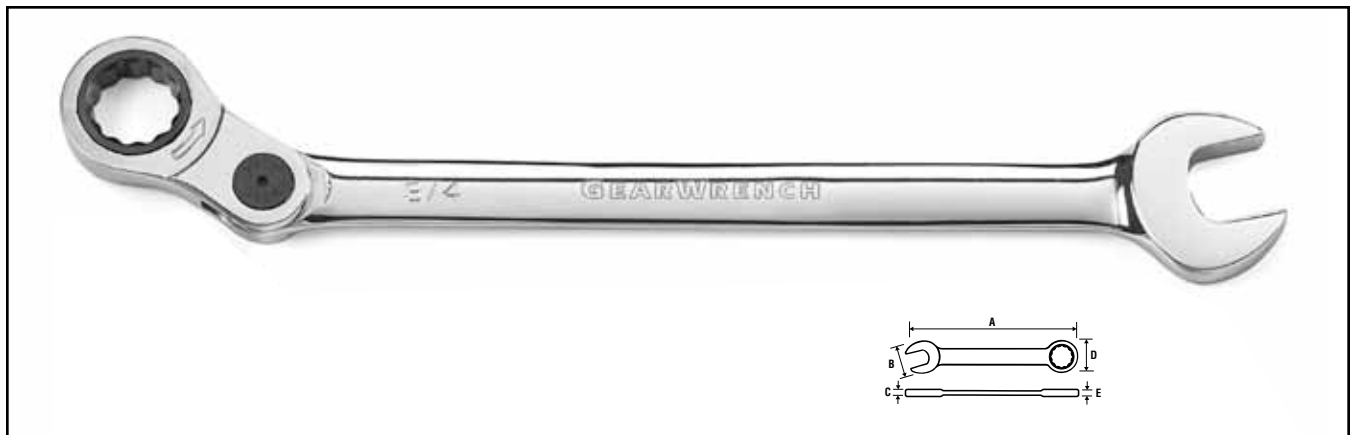

Open Stock - Indexing Combination Wrenches SAE/METRIC

Item No.	Opening Inches/Metric	Overall Length (inch) A	Width Open End (inch) B	Thickness Open End (inch) C	Width Box End (inch) D	Thickness Box End (inch) E	Weight (lbs)
85450	5/16"	4.949	0.709	0.197	0.535	0.127	0.046
85452	3/8"	5.909	0.906	0.220	0.574	0.127	0.062
85454	7/16"	6.417	0.984	0.240	0.618	0.127	0.071
85456	1/2"	7.217	1.102	0.303	0.685	0.171	0.093
85458	9/16"	7.665	1.260	0.307	0.728	0.171	0.121
85460	5/8"	8.508	1.378	0.346	0.813	0.197	0.143
85462	11/16"	9.016	1.496	0.370	0.844	0.197	0.196
85464	3/4"	10.122	1.654	0.386	0.883	0.197	0.273
85418	8 mm	4.949	0.709	0.197	0.535	0.127	0.064
85439	9 mm	5.394	0.787	0.209	0.543	0.127	0.090
85440	10 mm	5.909	0.906	0.220	0.574	0.127	0.123
85441	11 mm	6.417	0.984	0.240	0.618	0.127	0.141
85442	12 mm	6.783	1.063	0.260	0.660	0.171	0.176
85443	13 mm	7.217	1.102	0.303	0.685	0.171	0.185
85444	14 mm	7.665	1.260	0.307	0.728	0.171	0.236
85445	15 mm	8.185	1.299	0.315	0.766	0.171	0.287
85446	16 mm	8.508	1.378	0.346	0.813	0.197	0.340
85447	17 mm	9.016	1.496	0.370	0.844	0.197	0.414
85448	18 mm	9.555	1.535	0.370	0.851	0.197	0.428
85449	19 mm	10.122	1.654	0.386	0.883	0.197	0.708

OPEN STOCK

WRENCHES

Open End *Ratcheting Wrenches*



85597 - 12 Pc. Open End Ratcheting Set METRIC

Item No.	Description	
85508	8 mm	Ratcheting Open End Wrench
85509	9 mm	Ratcheting Open End Wrench
85510	10 mm	Ratcheting Open End Wrench
85511	11 mm	Ratcheting Open End Wrench
85512	12 mm	Ratcheting Open End Wrench
85513	13 mm	Ratcheting Open End Wrench
85514	14 mm	Ratcheting Open End Wrench
85515	15 mm	Ratcheting Open End Wrench
85516	16 mm	Ratcheting Open End Wrench
85517	17 mm	Ratcheting Open End Wrench
85518	18 mm	Ratcheting Open End Wrench
85519	19 mm	Ratcheting Open End Wrench



85599 - 8 Pc. Open End Ratcheting Set SAE

Item No.	Description	
85570	5/16"	Ratcheting Open End Wrench
85572	3/8"	Ratcheting Open End Wrench
85574	7/16"	Ratcheting Open End Wrench
85576	1/2"	Ratcheting Open End Wrench
85578	9/16"	Ratcheting Open End Wrench
85580	5/8"	Ratcheting Open End Wrench
85582	11/16"	Ratcheting Open End Wrench
85584	3/4"	Ratcheting Open End Wrench

SETS
WRENCHES

Open End Ratcheting Wrenches

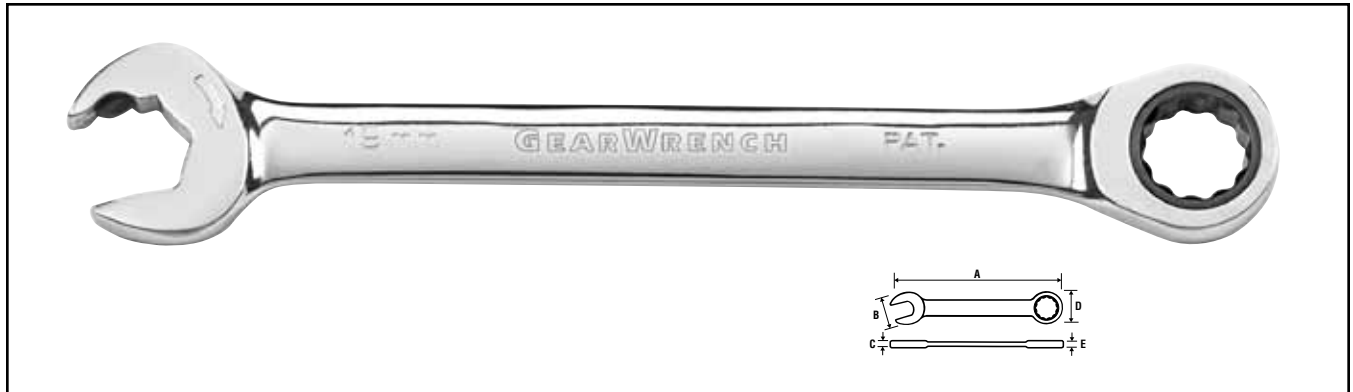

Open Stock - Open End Ratcheting Wrenches SAE/METRIC

Item No.	Opening Inches/Metric	Overall Length (inch) A	Width Open End (inch) B	Thickness Open End (inch) C	Width Box End (inch) D	Thickness Box End (inch) E	Weight (lbs)
85570	5/16"	5.508	0.658	0.197	0.625	0.256	0.046
85572	3/8"	6.256	0.822	0.220	0.750	0.287	0.062
85574	7/16"	6.508	0.905	0.240	0.811	0.303	0.071
85576	1/2"	7.008	1.069	0.303	0.930	0.339	0.093
85578	9/16"	7.504	1.152	0.307	1.020	0.354	0.121
85580	5/8"	8.201	1.316	0.346	1.130	0.390	0.143
85582	11/16"	8.878	1.399	0.370	1.201	0.406	0.196
85584	3/4"	9.764	1.563	0.386	1.278	0.441	0.273
85508	8 mm	5.508	0.658	0.197	0.625	0.256	0.064
85509	9 mm	5.882	0.741	0.209	0.689	0.272	0.090
85510	10 mm	6.256	0.822	0.220	0.750	0.287	0.123
85511	11 mm	6.508	0.905	0.240	0.811	0.303	0.141
85512	12 mm	6.756	0.988	0.260	0.855	0.323	0.176
85513	13 mm	7.008	1.069	0.303	0.930	0.339	0.185
85514	14 mm	7.504	1.152	0.307	1.020	0.354	0.236
85515	15 mm	7.854	1.233	0.315	1.070	0.370	0.287
85516	16 mm	8.201	1.316	0.346	1.130	0.390	0.340
85517	17 mm	8.878	1.399	0.370	1.201	0.406	0.414
85518	18 mm	9.315	1.480	0.370	1.239	0.421	0.428
85519	19 mm	9.764	1.563	0.386	1.278	0.441	0.708

OPEN STOCK
WRENCHES

QuadBox™ Ratcheting Wrenches

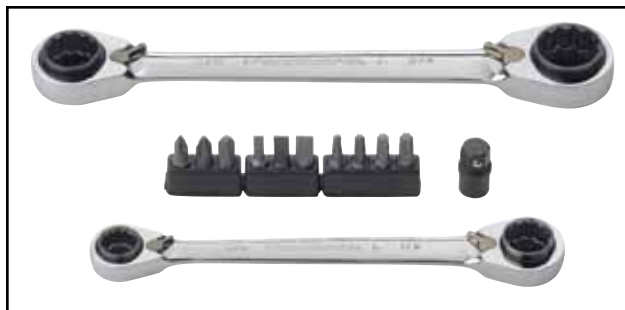

85200 - 13 Pc. QuadBox™ Double Box Ratcheting Wrench Set SAE

Item No.	Description
85201	5/16", 3/8", 7/16", 1/2" QuadBox™ Ratcheting Wrench
85202	9/16", 5/8", 11/16", 3/4" QuadBox™ Ratcheting Wrench
	1/4" Access Bit Adapter
#1	Phillips Bit 1/4"
#2	Phillips Bit 1/4"
#3	Phillips Bit 1/4"
5/32	Slotted Bit 1/4"
7/32	Slotted Bit 1/4"
1/4	Slotted Bit 1/4"
T-15	Torx® Bit 1/4"
T-20	Torx® Bit 1/4"
T-25	Torx® Bit 1/4"
T-27	Torx® Bit 1/4"

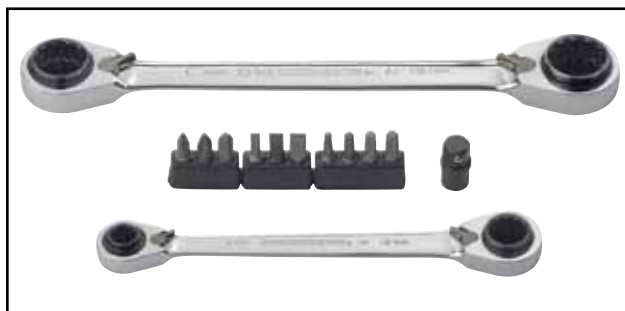

85210 - 13 Pc. QuadBox™ Double Box Ratcheting Wrench Set METRIC

Item No.	Description
85211	8, 10, 12, 13 mm QuadBox™ Ratcheting Wrench
85212	16, 17, 18, 19 mm QuadBox™ Ratcheting Wrench
	1/4" Access Bit Adapter
#1	Phillips Bit 1/4"
#2	Phillips Bit 1/4"
#3	Phillips Bit 1/4"
5/32	Slotted Bit 1/4"
7/32	Slotted Bit 1/4"
1/4	Slotted Bit 1/4"
T-15	Torx® Bit 1/4"
T-20	Torx® Bit 1/4"
T-25	Torx® Bit 1/4"
T-27	Torx® Bit 1/4"



SETS
WRENCHES

QuadBox™ Ratcheting Wrenches

85204 - 3 Pc. QuadBox™ Double Box Ratcheting Wrench Set SAE

Item No.	Description
85201	5/16", 3/8", 7/16", 1/2" QuadBox™ Ratcheting Wrench
85202	9/16", 5/8", 11/16", 3/4" QuadBox™ Ratcheting Wrench
85203	13/16", 7/8", 15/16", 1" QuadBox™ Ratcheting Wrench



85215 - 4 Pc. QuadBox™ Double Box Ratcheting Wrench Set METRIC

Item No.	Description
85211	8, 10, 12, 13 mm QuadBox™ Ratcheting Wrench
85212	16, 17, 18, 19 mm QuadBox™ Ratcheting Wrench
85213	9, 11, 14, 15 mm QuadBox™ Ratcheting Wrench
85214	20, 21, 22, 24 mm QuadBox™ Ratcheting Wrench

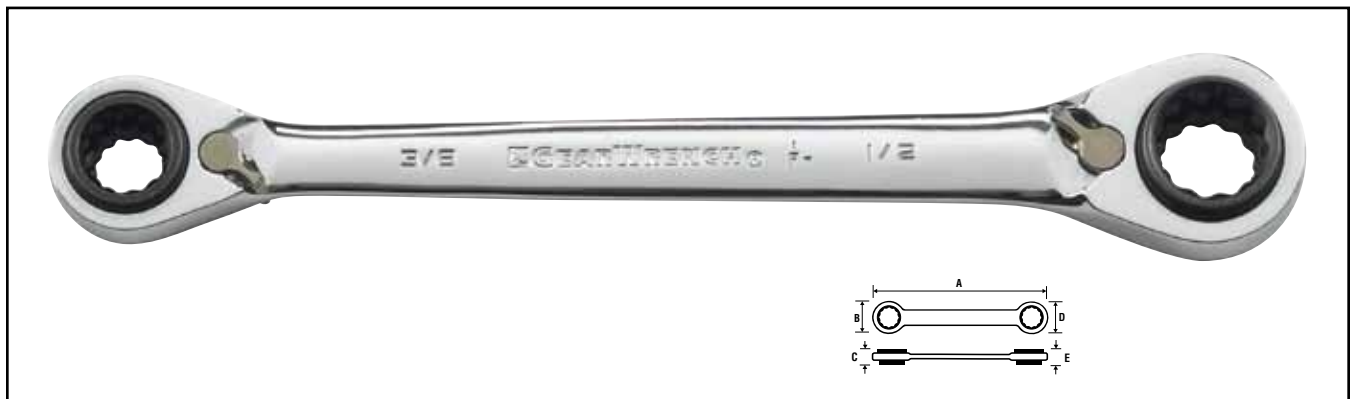

Open Stock - QuadBox™ Ratcheting Wrench SAE/METRIC

Item No.	Opening Inches/Metric	Overall Length (inch) A	Width Box End (inch) B	Thickness Box End (inch) C	Width Box End (inch) D	Thickness Box End (inch) E	Weight (lbs)
85201	5/16", 3/8", 7/16", 1/2"	6.3	0.78	0.47	0.98	0.59	0.185
85202	9/16", 5/8", 11/16", 3/4"	8.27	1.2	0.67	1.34	0.75	0.449
85203	13/16", 7/8", 15/16", 1"	11.42	1.54	0.91	1.79	1.1	1.10
85211	8, 10, 12, 13 mm	6.3	0.78	0.47	0.98	0.59	0.189
85212	16, 17, 18, 19 mm	9.06	1.27	0.71	1.34	0.79	0.491
85213	9, 11, 14, 15 mm	7.09	0.85	0.51	1.13	0.63	0.253
85214	20, 21, 22, 24 mm	11.42	1.54	0.91	1.79	1.1	1.056

SETS

WRENCHES

QuadBox™ Ratcheting Wrenches

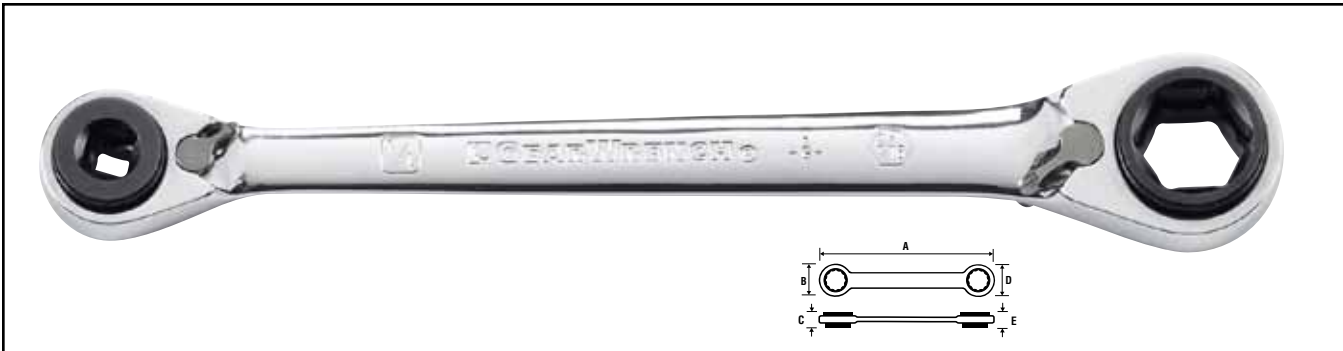

Open Stock - QuadBox™ HVAC Ratcheting Wrench SAE

Item No.	Opening Inches	Overall Length (inch) A	Width Box End (inch) B	Thickness Box End (inch) C	Width Box End (inch) D	Thickness Box End (inch) E	Weight (lbs)
85220	1/4" x 3/16" (Square) 3/8" x 5/16" (Square)	5.512	0.780	0.496	0.850	0.488	0.176
85221	1/4" x 3/16" (Square) 9/16" x 1/2" (Hex)	6.890	0.780	0.496	1.035	0.598	0.240



9260 - 6 Pc. Double Box Ratcheting Wrench Set METRIC

Item No.	Description
9210	8 X 9 mm Double Box Ratcheting Wrench
9211	10 X 11 mm Double Box Ratcheting Wrench
9212	12 X 13 mm Double Box Ratcheting Wrench
9213	14 X 15 mm Double Box Ratcheting Wrench
9214	16 X 18 mm Double Box Ratcheting Wrench
9215	17 X 19 mm Double Box Ratcheting Wrench



9240 - 4 Pc. Double Box Ratcheting Wrench Set SAE

Item No.	Description
9201	5/16" x 3/8" Double Box Ratcheting Wrench
9202	7/16" x 1/2" Double Box Ratcheting Wrench
9203	9/16" x 5/8" Double Box Ratcheting Wrench
9204	11/16" x 3/4" Double Box Ratcheting Wrench

PATENTED

OPEN STOCK
WRENCHES

Double Box Ratcheting Wrenches



Open Stock - Double Box Ratcheting Wrench SAE/METRIC

Item No.	Opening Inches/Metric	Overall Length (inch) A	Width Box End (inch) B	Thickness Box End (inch) C	Width Box End (inch) D	Thickness Box End (inch) E	Weight (lbs)
9201	5/16" x 3/8"	5.118	0.665	0.272	0.705	0.272	0.087
9202	7/16" x 1/2"	6.299	0.854	0.323	0.984	0.339	0.16
9203	9/16" x 5/8"	7.480	1.035	0.370	1.201	0.406	0.272
9204	11/16" x 3/4"	9.055	1.272	0.421	1.339	0.441	0.45
9210	8 X 9 mm	5.118	0.665	0.272	0.705	0.272	0.866
9211	10 X 11 mm	5.906	0.780	0.303	0.854	0.323	0.126
9212	12 X 13 mm	6.693	0.906	0.339	0.984	0.339	0.187
9213	14 X 15 mm	7.480	1.035	0.370	1.130	0.390	0.248
9214	16 X 18 mm	8.268	1.201	0.406	1.307	0.441	0.373
9215	17 X 19 mm	9.055	1.272	0.421	1.339	0.441	0.462

9850 - 5 Pc. Half Moon Reversible Double Box Ratcheting Wrench Set METRIC

Item No.	Description
9851	10 x 12 mm Half Moon Ratcheting Wrench
9852	11 x 13 mm Half Moon Ratcheting Wrench
9853	14 x 16 mm Half Moon Ratcheting Wrench
9854	15 x 17 mm Half Moon Ratcheting Wrench
9855	19 x 22 mm Half Moon Ratcheting Wrench



9840 - 4 Pc. Half Moon Reversible Double Box Ratcheting Wrench Set SAE

Item No.	Description
9841	3/8" x 7/16" Half Moon Ratcheting Wrench
9842	1/2" x 9/16" Half Moon Ratcheting Wrench
9843	5/8" x 11/16" Half Moon Ratcheting Wrench
9844	3/4" x 7/8" Half Moon Ratcheting Wrench



PATENTED

OPEN STOCK
WRENCHES

Half Moon Ratcheting Wrenches



Open Stock - Half Moon Reversible Double Box Ratcheting Wrench SAE/METRIC

Item No.	Opening Inches/Metric	Overall Length (inch) A	Width Box End (inch) B	Thickness Box End (inch) C	Width Box End (inch) D	Thickness Box End (inch) E	Weight (lbs)
9841	3/8" x 7/16"	5.157	0.780	0.303	0.906	0.323	0.185
9842	1/2" x 9/16"	6.220	0.984	0.339	1.035	0.370	0.449
9843	5/8" x 11/16"	7.913	1.201	0.406	1.307	0.421	1.10
9844	3/4" x 7/8"	9.094	1.339	0.441	1.535	0.512	0.189
9851	10 x 12 mm	5.157	0.780	0.303	0.906	0.339	0.491
9852	11 x 13 mm	5.787	0.854	0.323	0.984	0.339	0.253
9853	14 x 16 mm	6.654	1.035	0.370	1.272	0.406	1.056
9854	15 x 17 mm	7.913	1.201	0.390	1.307	0.421	1.294
9855	19 x 22 mm	9.094	1.339	0.441	1.535	0.512	1.316

OPEN STOCK

WRENCHES



85299 - 5 Pc. S-Shape Reversible Double Box Ratcheting Wrench Set METRIC

Item No.	Description
85222	10 x 12 mm S-Shape Ratcheting Wrench
85224	11 x 13 mm S-Shape Ratcheting Wrench
85230	14 x 16 mm S-Shape Ratcheting Wrench
85232	15 x 17 mm S-Shape Ratcheting Wrench
85241	19 x 22 mm S-Shape Ratcheting Wrench

PATENTED

S-Shape Ratcheting Wrenches

85399 - 4 Pc. S-Shape Reversible Double Box Ratcheting Wrench Set SAE

Item No.	Description
85326	3/8" x 7/16" S-Shape Ratcheting Wrench
85334	1/2" x 9/16" S-Shape Ratcheting Wrench
85342	5/8" x 11/16" S-Shape Ratcheting Wrench
85352	3/4" x 7/8" S-Shape Ratcheting Wrench

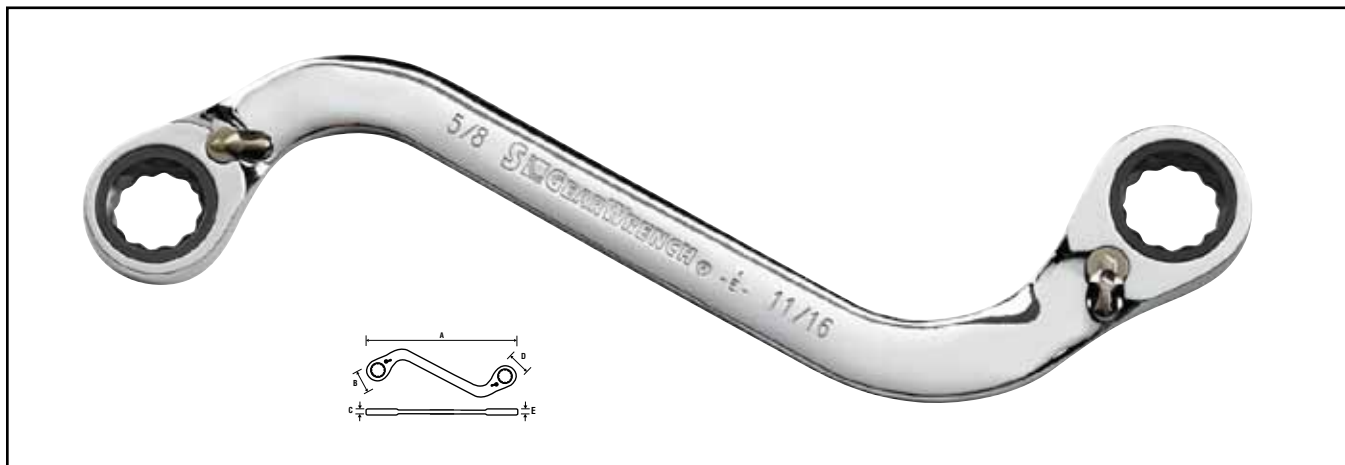

Open Stock - S-Shape Reversible Double Box Ratcheting Wrench SAE/METRIC

Item No.	Opening Inches/Metric	Overall Length (inch) A	Width Box End (inch) B	Thickness Box End (inch) C	Width Box End (inch) D	Thickness Box End (inch) E	Weight (lbs)
85326	3/8" x 7/16"	8.811	1.535	0.512	1.339	0.441	0.182
85334	1/2" x 9/16"	6.268	0.984	0.370	1.035	0.339	0.291
85342	5/8" x 11/16"	8.114	1.307	0.421	1.201	0.406	0.55
85352	3/4" x 7/8"	8.811	1.535	0.512	1.339	0.441	0.825
85222	10 x 12 mm	5.217	0.906	0.339	0.780	0.303	0.181
85224	11 x 13 mm	5.650	0.984	0.339	0.854	0.323	0.225
85230	14 x 16 mm	6.906	1.272	0.406	1.035	0.370	0.399
85232	15 x 17 mm	8.114	1.307	0.421	1.201	0.390	0.554
85241	19 x 22 mm	8.811	1.535	0.512	1.339	0.441	0.818

SETS
WRENCHES

E-Torx® Ratcheting Wrenches

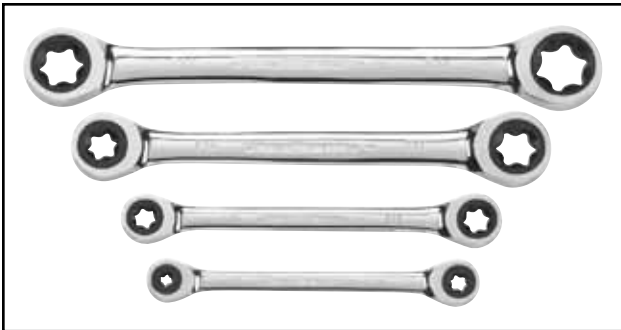

9224 - 4 Pc. E-Torx® Double Box Ratcheting Wrench Set TORX®

Item No.	Description	
9220	E6 x E8	E-Torx Ratcheting Wrench
9221	E10 x E12	E-Torx Ratcheting Wrench
9222	E14 x E18	E-Torx Ratcheting Wrench
9223	E20 x E24	E-Torx Ratcheting Wrench



Open Stock - E-Torx® Double Box Ratcheting Wrenches TORX®

Item No.	Opening Inches/Metric	Overall Length (inch) A	Width Box End (inch) B	Thickness Box End (inch) C	Width Box End (inch) D	Thickness Box End (inch) E	Weight (lbs)
9220	E6 x E8	5.118	0.630	0.689	0.256	0.272	0.094
9221	E10 x E12	5.906	0.748	0.811	0.287	0.303	0.135
9222	E14 x E18	7.480	0.849	1.130	0.354	0.390	0.300
9223	E20 x E24	9.055	1.201	1.280	0.406	0.441	0.554

SETS
WRENCHES



9537 - 37 Pc. Access Bit Set with 1/2" Reversible Ratcheting Wrench

Item No.	Description	
9528	1/2"	Combination Ratcheting Wrench
	1/4"	Access Bit Adapter
	5/16"	Access Bit Adapter
34	Assorted Bits with Holder See Set 9536 for Complete Listing of Bits Included	

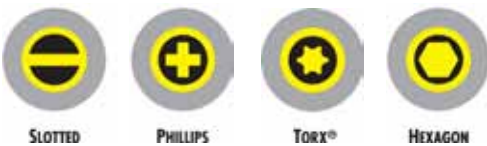

Open Stock *Ratcheting Wrenches*

9536 - 36 Pc. Access Bit Set

1/4"	Access Bit Adapter	2.5 mm	Hex Bit 1/4"
5/16"	Access Bit Adapter	3 mm	Hex Bit 1/4"
#1	Phillips Bit 1/4"	4 mm	Hex Bit 1/4"
#2	Phillips Bit 1/4"	5 mm	Hex Bit 1/4"
#3	Phillips Bit 1/4"	6 mm	Hex Bit 1/4"
1/4	Slotted Bit 1/4"	7 mm	Hex Bit 3/8"
9/32	Slotted Bit 1/4"	8 mm	Hex Bit 3/8"
3/32	Hex Bit 1/4"	10 mm	Hex Bit 3/8"
7/64	Hex Bit 1/4"	T-10	Torx® Bit 1/4"
1/8	Hex Bit 1/4"	T-15	Torx® Bit 1/4"
9/64	Hex Bit 1/4"	T-20	Torx® Bit 1/4"
5/32	Hex Bit 1/4"	T-25	Torx® Bit 1/4"
3/16	Hex Bit 1/4"	T-27	Torx® Bit 1/4"
7/32	Hex Bit 1/4"	T-30	Torx® Bit 1/4"
1/4	Hex Bit 1/4"	T-40	Torx® Bit 3/8"
5/16	Hex Bit 3/8"	T-45	Torx® Bit 3/8"
3/8	Hex Bit 3/8"	T-50	Torx® Bit 3/8"
2 mm	Hex Bit 1/4"	1/4"	Dr. Socket Adapter

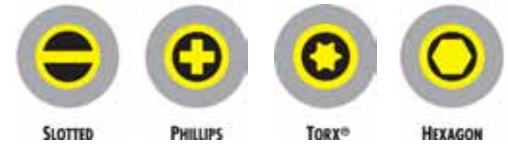
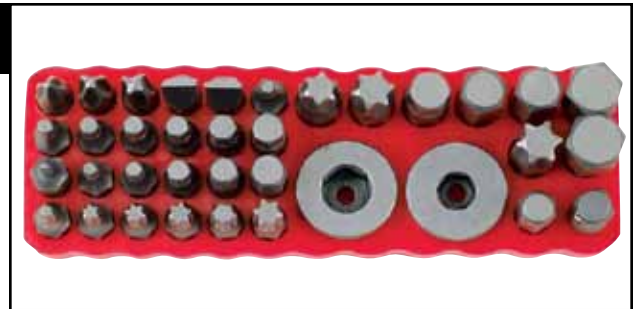

9535 - 2 Pc. Access Bit Adapter Set

Item No.	Description
1/4"	Access Bit Adapter
5/16"	Access Bit Adapter

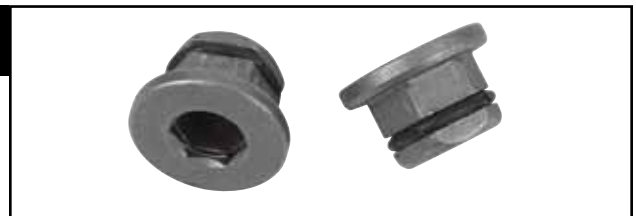

9230 - 3 Pc. Drive Adapter Set METRIC

Item No.	Description	Weight (lbs)
9207	1/4" Dr. x 10 mm	0.027
9208	3/8" Dr. x 13 mm	0.057
9209	1/2" Dr. x 19 mm	0.121



9231 - 3 Pc. Drive Adapter Set SAE

Item No.	Description	Weight (lbs)
9217	1/4" Dr. x 3/8"	0.026
9218	3/8" Dr. x 1/2"	0.055
9219	1/2" Dr. x 3/4"	0.122



PATENTED

**NON-RATCHETING
WRENCHES**

AVAILABLE IN:

- 6 Point
- 12 Point

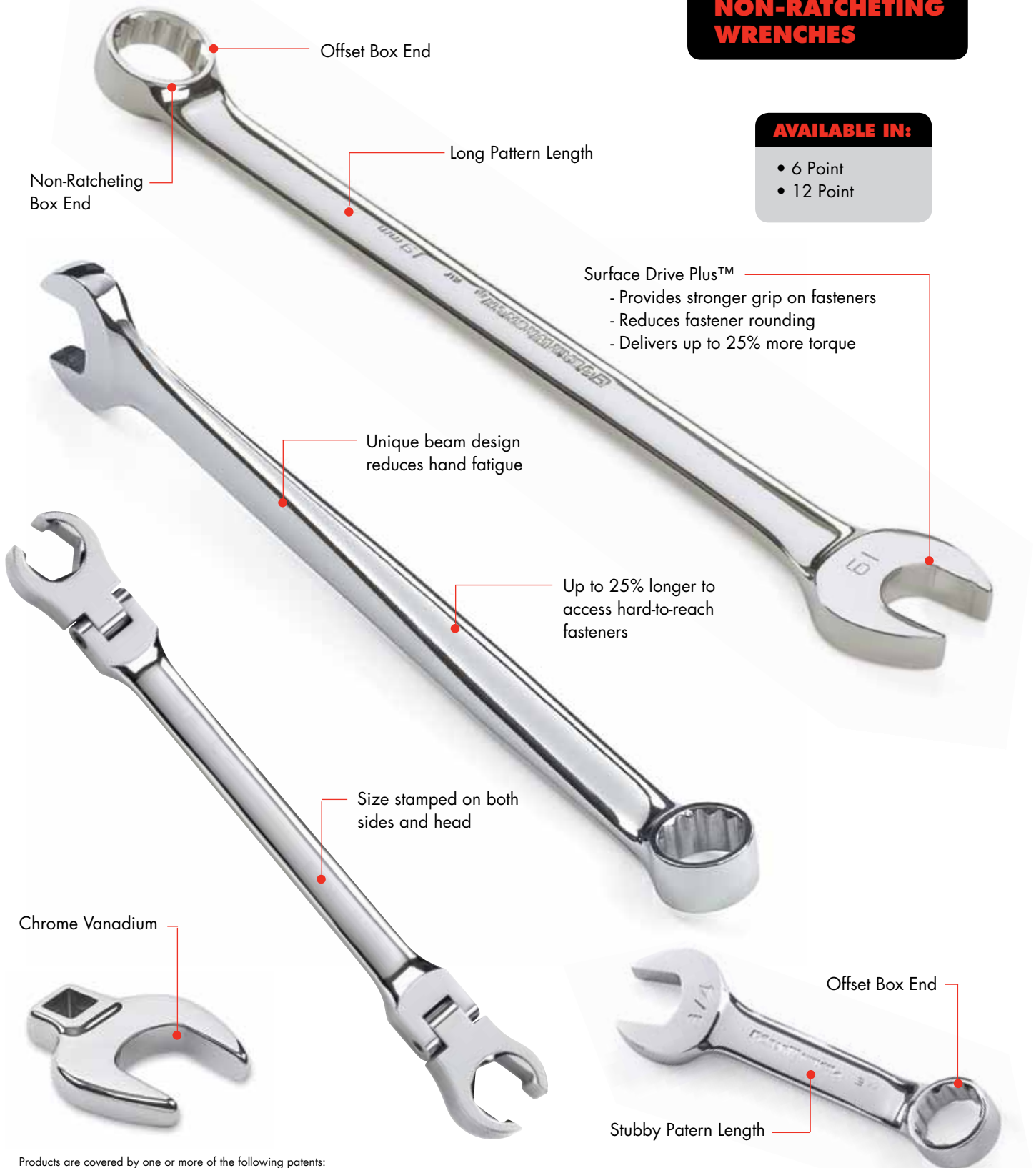

Offset Box End

Non-Ratcheting Box End

Long Pattern Length

Surface Drive Plus™

- Provides stronger grip on fasteners
- Reduces fastener rounding
- Delivers up to 25% more torque

Unique beam design reduces hand fatigue

Up to 25% longer to access hard-to-reach fasteners

Size stamped on both sides and head

Chrome Vanadium

Offset Box End

Stubby Pattern Length

Products are covered by one or more of the following patents:
 • US 6,263,769 US 6,267,028 US 6,082,228 D412819 D437536

WRENCHES

81912 - 12 Pc. XL X-Beam™ Combination Non-Ratcheting Wrench Set METRIC

Item No.	Description	
81698	8 mm	XL X-Beam™ Combination Wrench
81699	9 mm	XL X-Beam™ Combination Wrench
81700	10 mm	XL X-Beam™ Combination Wrench
81701	11 mm	XL X-Beam™ Combination Wrench
81703	12 mm	XL X-Beam™ Combination Wrench
81705	13 mm	XL X-Beam™ Combination Wrench
81706	14 mm	XL X-Beam™ Combination Wrench
81707	15 mm	XL X-Beam™ Combination Wrench
81709	16 mm	XL X-Beam™ Combination Wrench
81710	17 mm	XL X-Beam™ Combination Wrench
81711	18 mm	XL X-Beam™ Combination Wrench
81713	19 mm	XL X-Beam™ Combination Wrench



81913 - 9 Pc. XL X-Beam™ Combination Non-Ratcheting Wrench Set SAE

Item No.	Description	
81714	5/16"	XL X-Beam™ Combination Wrench
81715	11/32"	XL X-Beam™ Combination Wrench
81717	3/8"	XL X-Beam™ Combination Wrench
81718	7/16"	XL X-Beam™ Combination Wrench
81719	1/2"	XL X-Beam™ Combination Wrench
81721	9/16"	XL X-Beam™ Combination Wrench
81722	5/8"	XL X-Beam™ Combination Wrench
81723	11/16"	XL X-Beam™ Combination Wrench
81725	3/4"	XL X-Beam™ Combination Wrench



SETS
WRENCHES



Open Stock - XL X-Beam™ Combination Non-Ratcheting Wrenches SAE/METRIC

Item No.	Opening Inches/Metric	Overall Length (inch) A	Width Open End (inch) B	Thickness Open End (inch) C	Width Open End (inch) D	Thickness Open End (inch) E	Weight (lbs)
81714	5/16"	5.790	0.709	0.197	0.524	0.228	0.101
81715	11/32"	6.220	0.787	0.205	0.571	0.256	0.182
81717	3/8"	6.540	0.955	0.224	0.622	0.283	0.211
81718	7/16"	7.280	0.984	0.248	0.673	0.307	0.257
81719	1/2"	8.110	1.102	0.276	0.768	0.346	0.303
81721	9/16"	8.720	1.260	0.295	0.835	0.378	0.412
81722	5/8"	9.510	1.378	0.315	0.929	0.425	0.532
81723	11/16"	10.220	1.496	0.354	1.004	0.445	0.622
81725	3/4"	10.960	1.654	0.374	1.087	0.488	0.788
81698	8 mm	5.790	0.709	0.197	0.524	0.228	0.101
81699	9 mm	6.220	0.787	0.205	0.571	0.256	0.182
81700	10 mm	6.540	0.906	0.224	0.622	0.283	0.211
81701	11 mm	7.280	0.984	0.248	0.673	0.307	0.257
81703	12 mm	7.720	1.063	0.264	0.717	0.339	0.309
81705	13 mm	8.110	1.102	0.276	0.768	0.346	0.309
81706	14 mm	8.720	1.260	0.295	0.835	0.378	0.413
81707	15 mm	9.130	1.299	0.315	0.878	0.402	0.467
81709	16 mm	9.510	1.378	0.315	0.929	0.425	0.532
81710	17 mm	10.220	1.496	0.354	1.004	0.445	0.622
81711	18 mm	10.590	1.516	0.354	1.035	0.465	0.694
81713	19 mm	10.960	1.654	0.374	1.087	0.488	0.788

OPEN STOCK
WRENCHES

**81919 - 44 Pc. Long Pattern Combination
Non-Ratcheting Wrench Set SAE/METRIC**

Item No.	Description	
81650	1/4"	Long Pattern Combination Wrench
81652	5/16"	Long Pattern Combination Wrench
81653	11/32"	Long Pattern Combination Wrench
81654	3/8"	Long Pattern Combination Wrench
81655	7/16"	Long Pattern Combination Wrench
81656	1/2"	Long Pattern Combination Wrench
81657	9/16"	Long Pattern Combination Wrench
81658	5/8"	Long Pattern Combination Wrench
81659	11/16"	Long Pattern Combination Wrench
81660	3/4"	Long Pattern Combination Wrench
81661	13/16"	Long Pattern Combination Wrench
81662	7/8"	Long Pattern Combination Wrench
81663	15/16"	Long Pattern Combination Wrench
81664	1"	Long Pattern Combination Wrench
81733	1-1/6"	Long Pattern Combination Wrench
81734	1-1/8"	Long Pattern Combination Wrench
81735	1-1/4"	Long Pattern Combination Wrench
81749	1-5/16"	Long Pattern Combination Wrench
81750	1-1/2"	Long Pattern Combination Wrench
81736	6 mm	Long Pattern Combination Wrench
81737	7 mm	Long Pattern Combination Wrench
81665	8 mm	Long Pattern Combination Wrench
81666	9 mm	Long Pattern Combination Wrench
81667	10 mm	Long Pattern Combination Wrench
81668	11 mm	Long Pattern Combination Wrench
81669	12 mm	Long Pattern Combination Wrench
81670	13 mm	Long Pattern Combination Wrench
81671	14 mm	Long Pattern Combination Wrench
81672	15 mm	Long Pattern Combination Wrench



Item No.	Description	
81673	16 mm	Long Pattern Combination Wrench
81674	17 mm	Long Pattern Combination Wrench
81675	18 mm	Long Pattern Combination Wrench
81676	19 mm	Long Pattern Combination Wrench
81677	20 mm	Long Pattern Combination Wrench
81678	21 mm	Long Pattern Combination Wrench
81679	22 mm	Long Pattern Combination Wrench
81741	23 mm	Long Pattern Combination Wrench
81742	24 mm	Long Pattern Combination Wrench
81751	25 mm	Long Pattern Combination Wrench
81752	26 mm	Long Pattern Combination Wrench
81743	27 mm	Long Pattern Combination Wrench
81753	28 mm	Long Pattern Combination Wrench
81744	30 mm	Long Pattern Combination Wrench
81745	32 mm	Long Pattern Combination Wrench

SETS
WRENCHES

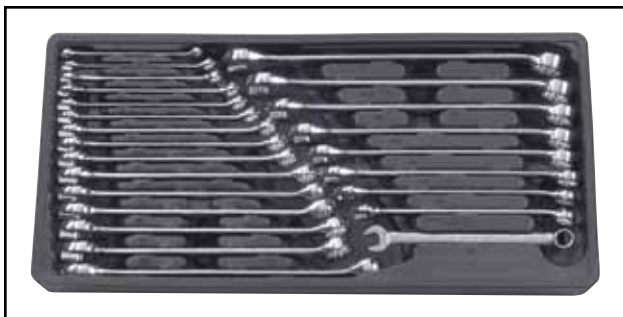

**81900 - 24 Pc. Long Pattern Combination
Non-Ratcheting Wrench Set SAE/METRIC**

Item No.	Description
81656	1/2" Long Pattern Combination Wrench
81657	9/16" Long Pattern Combination Wrench
81658	5/8" Long Pattern Combination Wrench
81659	11/16" Long Pattern Combination Wrench
81660	3/4" Long Pattern Combination Wrench
81661	13/16" Long Pattern Combination Wrench
81662	7/8" Long Pattern Combination Wrench
81663	15/16" Long Pattern Combination Wrench
81664	1" Long Pattern Combination Wrench

Item No.	Description
81665	8 mm Long Pattern Combination Wrench
81666	9 mm Long Pattern Combination Wrench
81667	10 mm Long Pattern Combination Wrench
81668	11 mm Long Pattern Combination Wrench
81669	12 mm Long Pattern Combination Wrench
81670	13 mm Long Pattern Combination Wrench
81671	14 mm Long Pattern Combination Wrench
81672	15 mm Long Pattern Combination Wrench
81673	16 mm Long Pattern Combination Wrench
81674	17 mm Long Pattern Combination Wrench
81675	18 mm Long Pattern Combination Wrench
81676	19 mm Long Pattern Combination Wrench
81677	20 mm Long Pattern Combination Wrench
81678	21 mm Long Pattern Combination Wrench
81679	22 mm Long Pattern Combination Wrench



**81901 - 15 Pc. Long Pattern Combination
Non-Ratcheting Wrench Set SAE**

Item No.	Description
81652	5/16" Long Pattern Combination Wrench
81653	11/32" Long Pattern Combination Wrench
81654	3/8" Long Pattern Combination Wrench
81655	7/16" Long Pattern Combination Wrench
81656	1/2" Long Pattern Combination Wrench
81657	9/16" Long Pattern Combination Wrench
81658	5/8" Long Pattern Combination Wrench
81659	11/16" Long Pattern Combination Wrench
81660	3/4" Long Pattern Combination Wrench
81661	13/16" Long Pattern Combination Wrench
81662	7/8" Long Pattern Combination Wrench
81663	15/16" Long Pattern Combination Wrench
81664	1" Long Pattern Combination Wrench
81650	1/4" Long Pattern Combination Wrench
81651	9/32" Long Pattern Combination Wrench

SETS
WRENCHES

81917 - 18 Pc. Long Pattern Combination Non-Ratcheting Wrench Set SAE

Item No.	Description	
81650	1/4"	Long Pattern Combination Wrench
81651	9/32"	Long Pattern Combination Wrench
81652	5/16"	Long Pattern Combination Wrench
81653	11/32"	Long Pattern Combination Wrench
81654	3/8"	Long Pattern Combination Wrench
81655	7/16"	Long Pattern Combination Wrench
81656	1/2"	Long Pattern Combination Wrench
81657	9/16"	Long Pattern Combination Wrench
81658	5/8"	Long Pattern Combination Wrench
81659	11/16"	Long Pattern Combination Wrench
81660	3/4"	Long Pattern Combination Wrench
81661	13/16"	Long Pattern Combination Wrench
81662	7/8"	Long Pattern Combination Wrench
81663	15/16"	Long Pattern Combination Wrench



Item No.	Description	
81664	1"	Long Pattern Combination Wrench
81733	1-1/6"	Long Pattern Combination Wrench
81734	1-1/8"	Long Pattern Combination Wrench
81735	1-1/4"	Long Pattern Combination Wrench

81918 - 15 Pc. Long Pattern Combination Non-Ratcheting Wrench Set SAE

Item No.	Description	
81652	5/16"	Long Pattern Combination Wrench
81654	3/8"	Long Pattern Combination Wrench
81655	7/16"	Long Pattern Combination Wrench
81656	1/2"	Long Pattern Combination Wrench
81657	9/16"	Long Pattern Combination Wrench
81658	5/8"	Long Pattern Combination Wrench
81659	11/16"	Long Pattern Combination Wrench
81660	3/4"	Long Pattern Combination Wrench
81661	13/16"	Long Pattern Combination Wrench
81662	7/8"	Long Pattern Combination Wrench
81663	15/16"	Long Pattern Combination Wrench
81664	1"	Long Pattern Combination Wrench
81733	1-1/16"	Long Pattern Combination Wrench
81734	1-1/8"	Long Pattern Combination Wrench
81735	1-1/4"	Long Pattern Combination Wrench





81902 - 15 Pc. Long Pattern Combination Non-Ratcheting Wrench Set METRIC

Item No.	Description	
81665	8 mm	Long Pattern Combination Wrench
81666	9 mm	Long Pattern Combination Wrench
81667	10 mm	Long Pattern Combination Wrench
81668	11 mm	Long Pattern Combination Wrench
81669	12 mm	Long Pattern Combination Wrench
81670	13 mm	Long Pattern Combination Wrench
81671	14 mm	Long Pattern Combination Wrench
81672	15 mm	Long Pattern Combination Wrench
81673	16 mm	Long Pattern Combination Wrench
81674	17 mm	Long Pattern Combination Wrench
81675	18 mm	Long Pattern Combination Wrench
81676	19 mm	Long Pattern Combination Wrench
81677	20 mm	Long Pattern Combination Wrench
81678	21 mm	Long Pattern Combination Wrench
81679	22 mm	Long Pattern Combination Wrench



81916 - 22 Pc. Long Pattern Combination Non-Ratcheting Wrench Set METRIC

Item No.	Description	
81670	13 mm	Long Pattern Combination Wrench
81671	14 mm	Long Pattern Combination Wrench
81672	15 mm	Long Pattern Combination Wrench
81673	16 mm	Long Pattern Combination Wrench
81674	17 mm	Long Pattern Combination Wrench
81675	18 mm	Long Pattern Combination Wrench
81676	19 mm	Long Pattern Combination Wrench
81677	20 mm	Long Pattern Combination Wrench
81678	21 mm	Long Pattern Combination Wrench
81679	22 mm	Long Pattern Combination Wrench
81741	23 mm	Long Pattern Combination Wrench
81742	24 mm	Long Pattern Combination Wrench
81743	27 mm	Long Pattern Combination Wrench
81744	30 mm	Long Pattern Combination Wrench
81745	32 mm	Long Pattern Combination Wrench

Item No.	Description	
81736	6 mm	Long Pattern Combination Wrench
81737	7 mm	Long Pattern Combination Wrench
81665	8 mm	Long Pattern Combination Wrench
81666	9 mm	Long Pattern Combination Wrench
81667	10 mm	Long Pattern Combination Wrench
81668	11 mm	Long Pattern Combination Wrench
81669	12 mm	Long Pattern Combination Wrench

SETS
WRENCHES

81920 - 18 Pc. Long Pattern Combination Non-Ratcheting Wrench Set METRIC

Item No.	Description	
81737	7 mm	Long Pattern Combination Wrench
81665	8 mm	Long Pattern Combination Wrench
81666	9 mm	Long Pattern Combination Wrench
81667	10 mm	Long Pattern Combination Wrench
81668	11 mm	Long Pattern Combination Wrench
81669	12 mm	Long Pattern Combination Wrench
81670	13 mm	Long Pattern Combination Wrench
81671	14 mm	Long Pattern Combination Wrench
81672	15 mm	Long Pattern Combination Wrench
81673	16 mm	Long Pattern Combination Wrench
81674	17 mm	Long Pattern Combination Wrench
81675	18 mm	Long Pattern Combination Wrench
81676	19 mm	Long Pattern Combination Wrench
81677	20 mm	Long Pattern Combination Wrench



Item No.	Description	
81678	21 mm	Long Pattern Combination Wrench
81679	22 mm	Long Pattern Combination Wrench
81741	23 mm	Long Pattern Combination Wrench
81742	24 mm	Long Pattern Combination Wrench

81921 - 5 Pc. Large Add-On Combination Non-Ratcheting Wrench Set SAE

Item No.	Description	
81733	1-1/6"	Long Pattern Combination Wrench
81734	1-1/8"	Long Pattern Combination Wrench
81735	1-1/4"	Long Pattern Combination Wrench
81749	1-5/16"	Long Pattern Combination Wrench
81750	1-1/2"	Long Pattern Combination Wrench



81922 - 6 Pc. Large Add-On Combination Non-Ratcheting Wrench Set METRIC

Item No.	Description	
81751	25 mm	Long Pattern Combination Wrench
81752	26 mm	Long Pattern Combination Wrench
81743	27 mm	Long Pattern Combination Wrench
81753	28 mm	Long Pattern Combination Wrench
81744	30 mm	Long Pattern Combination Wrench
81745	32 mm	Long Pattern Combination Wrench





Open Stock - Long Pattern Combination Non-Ratcheting Wrenches SAE/METRIC

Item No.	Opening Inches/Metric	Overall Length (inch) A	Width Open End (inch) B	Thickness Open End (inch) C	Width Box End (inch) D	Thickness Box End (inch) E	Weight (lbs)
81650	1/4"	5.090	0.520	0.161	0.449	0.197	0.046
81651	9/32"	5.440	0.567	0.169	0.484	0.209	0.062
81652	5/16"	5.800	0.654	0.177	0.535	0.217	0.071
81653	11/32"	6.220	0.728	0.185	0.583	0.244	0.093
81654	3/8"	6.540	0.807	0.213	0.634	0.272	0.121
81655	7/16"	7.290	0.894	0.236	0.685	0.295	0.143
81656	1/2"	8.110	1.051	0.252	0.780	0.335	0.196
81657	9/16"	8.740	1.138	0.276	0.846	0.366	0.273
81658	5/8"	9.520	1.291	0.303	0.941	0.413	0.328
81659	11/16"	10.230	1.382	0.319	1.016	0.433	0.408
81660	3/4"	10.972	1.551	0.362	1.098	0.476	0.525
81661	13/16"	11.827	1.701	0.390	1.201	0.520	0.635
81662	7/8"	12.520	1.783	0.406	1.264	0.539	0.705
81663	15/16"	13.252	1.945	0.429	1.327	0.579	0.899
81664	1"	14.035	2.024	0.445	1.398	0.598	0.977
81733	1-1/16"	14.750	2.220	0.469	1.531	0.650	1.496
81734	1-1/8"	16.000	2.469	0.500	1.685	0.697	1.848
81735	1-1/4"	16.000	2.634	0.524	1.811	0.724	2.134
81749	1-5/16"	18.740	3.102	0.610	2.185	0.925	2.056
81750	1-1/2"	19.720	3.102	0.610	2.185	0.925	2.061
81736	6 mm	5.094	0.520	0.161	0.449	0.197	0.066
81737	7 mm	5.445	0.567	0.169	0.484	0.209	0.077
81665	8 mm	5.799	0.654	0.177	0.535	0.217	0.064
81666	9 mm	6.220	0.728	0.185	0.583	0.244	0.090
81667	10 mm	6.543	0.807	0.213	0.634	0.272	0.123
81668	11 mm	7.291	0.894	0.236	0.685	0.295	0.141
81669	12 mm	7.736	0.969	0.244	0.728	0.327	0.176
81670	13 mm	8.114	1.051	0.252	0.780	0.335	0.185
81671	14 mm	8.740	1.138	0.276	0.846	0.366	0.236
81672	15 mm	9.134	1.213	0.291	0.890	0.390	0.287
81673	16 mm	9.524	1.291	0.303	0.941	0.413	0.340

OPEN STOCK

WRENCHES

Item No.	Opening Inches/Metric	Overall Length (inch) A	Width Open End (inch) B	Thickness Open End (inch) C	Width Box End (inch) D	Thickness Box End (inch) E	Weight (lbs)
81674	17 mm	10.232	1.382	0.319	1.016	0.433	0.414
81675	18 mm	10.602	1.461	0.339	1.047	0.453	0.428
81676	19 mm	10.970	1.55	0.360	1.080	0.472	0.550
81677	20 mm	11.400	1.65	0.381	1.110	0.491	0.620
81678	21 mm	11.830	1.700	0.400	1.140	0.510	0.683
81679	22 mm	12.520	1.783	0.406	1.264	0.539	0.708
81741	23 mm	12.752	1.870	0.417	1.287	0.559	0.902
81742	24 mm	13.252	1.945	0.429	1.327	0.579	1.034
81751	25 mm	14.035	2.024	0.445	1.398	0.598	2.077
81752	26 mm	14.331	2.138	0.449	1.472	0.622	2.891
81743	27 mm	14.752	2.220	0.469	1.531	0.650	1.540
81753	28 mm	16.000	2.469	0.500	1.685	0.697	2.931
81744	30 mm	17.000	2.555	0.524	1.685	0.724	2.046
81745	32 mm	17.362	2.634	0.524	1.811	0.724	2.047

**81923 - 28 Pc. Full Polish Combination
Non-Ratcheting Wrench Set SAE/METRIC**

Item No.	Description	
81768	1/4"	Full Polish Combination Wrench
81769	15/16"	Full Polish Combination Wrench
81770	11/32"	Full Polish Combination Wrench
81771	3/8"	Full Polish Combination Wrench
81772	7/16"	Full Polish Combination Wrench
81773	1/2"	Full Polish Combination Wrench
81774	9/16"	Full Polish Combination Wrench
81775	5/8"	Full Polish Combination Wrench
81776	11/16"	Full Polish Combination Wrench
81777	3/4"	Full Polish Combination Wrench
81778	13/16"	Full Polish Combination Wrench
81779	7/8"	Full Polish Combination Wrench
81780	15/16"	Full Polish Combination Wrench
81781	1"	Full Polish Combination Wrench
81754	6 mm	Full Polish Combination Wrench
81755	7 mm	Full Polish Combination Wrench
81756	8 mm	Full Polish Combination Wrench
81757	9 mm	Full Polish Combination Wrench
81758	10 mm	Full Polish Combination Wrench
81759	11 mm	Full Polish Combination Wrench

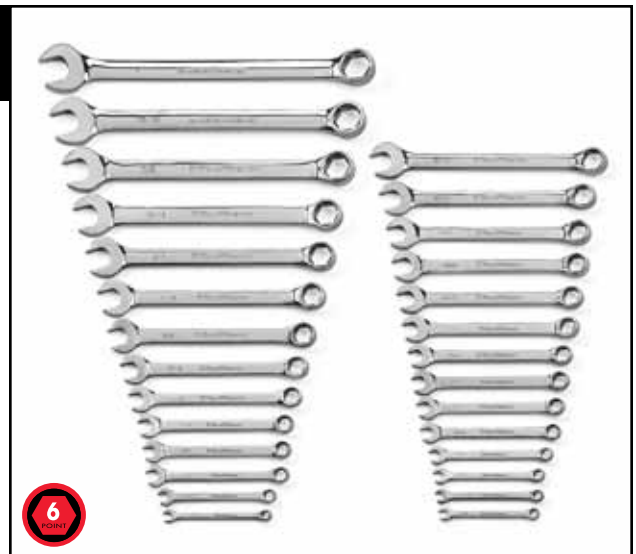

Item No.	Description	
81760	12 mm	Full Polish Combination Wrench
81761	13 mm	Full Polish Combination Wrench
81762	14 mm	Full Polish Combination Wrench
81763	15 mm	Full Polish Combination Wrench
81764	16 mm	Full Polish Combination Wrench
81765	17 mm	Full Polish Combination Wrench
81766	18 mm	Full Polish Combination Wrench
81767	19 mm	Full Polish Combination Wrench

SETS
WRENCHES

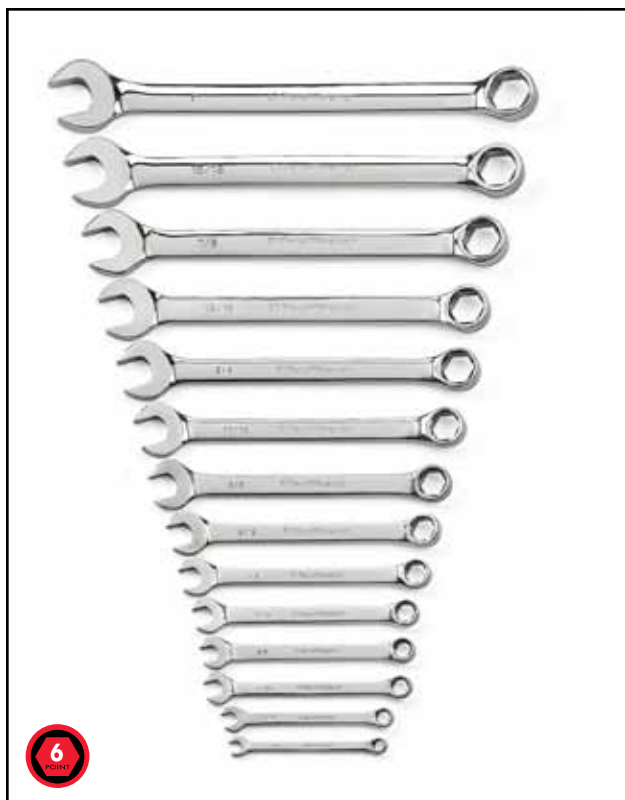

**81924 - 14 Pc. Full Polish Combination
Non-Ratcheting Wrench Set SAE**

Item No.	Description	
81768	1/4"	Full Polish Combination Wrench
81769	15/16"	Full Polish Combination Wrench
81770	11/32"	Full Polish Combination Wrench
81771	3/8"	Full Polish Combination Wrench
81772	7/16"	Full Polish Combination Wrench
81773	1/2"	Full Polish Combination Wrench
81774	9/16"	Full Polish Combination Wrench
81775	5/8"	Full Polish Combination Wrench
81776	11/16"	Full Polish Combination Wrench
81777	3/4"	Full Polish Combination Wrench
81778	13/16"	Full Polish Combination Wrench
81779	7/8"	Full Polish Combination Wrench
81780	15/16"	Full Polish Combination Wrench
81781	1"	Full Polish Combination Wrench

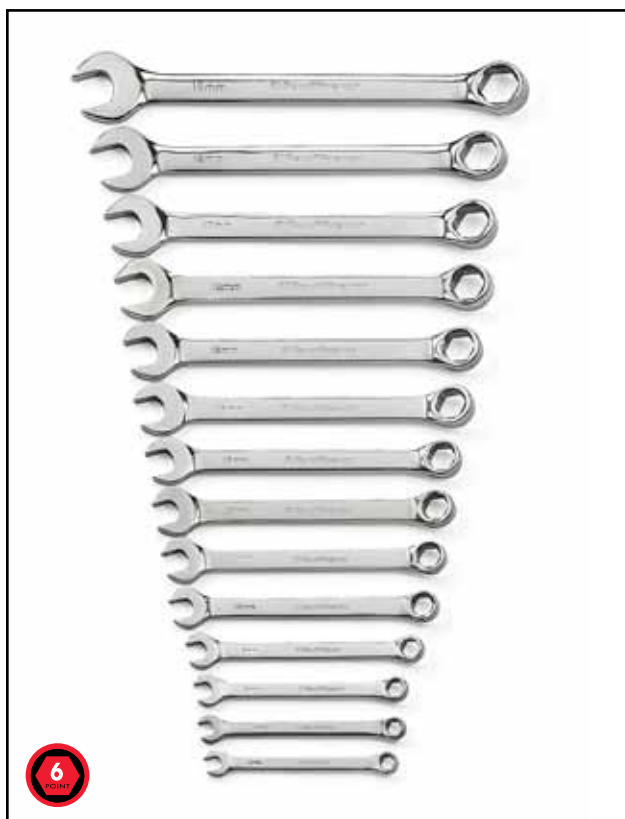

**81925 - 14 Pc. Full Polish Combination
Non-Ratcheting Wrench Set METRIC**

Item No.	Description	
81754	6 mm	Full Polish Combination Wrench
81755	7 mm	Full Polish Combination Wrench
81756	8 mm	Full Polish Combination Wrench
81757	9 mm	Full Polish Combination Wrench
81758	10 mm	Full Polish Combination Wrench
81759	11 mm	Full Polish Combination Wrench
81760	12 mm	Full Polish Combination Wrench
81761	13 mm	Full Polish Combination Wrench
81762	14 mm	Full Polish Combination Wrench
81763	15 mm	Full Polish Combination Wrench
81764	16 mm	Full Polish Combination Wrench
81765	17 mm	Full Polish Combination Wrench
81766	18 mm	Full Polish Combination Wrench
81767	19 mm	Full Polish Combination Wrench

SETS
WRENCHES



Open Stock - Full Polish Combination Non-Ratcheting Wrenches SAE/METRIC

Item No.	Opening Inches/Metric	Overall Length (inch) A	Width Open End (inch) B	Thickness Open End (inch) C	Width Box End (inch) D	Thickness Box End (inch) E	Weight (lbs)
81768	1/4"	5.094	0.520	0.161	0.449	0.197	0.046
81769	15/16"	13.252	1.945	0.429	1.327	0.579	0.062
81770	11/32"	6.220	0.728	0.185	0.583	0.244	0.071
81771	3/8"	6.543	0.807	0.213	0.634	0.272	0.093
81772	7/16"	7.291	0.894	0.236	0.685	0.295	0.121
81773	1/2"	8.114	1.051	0.252	0.780	0.335	0.143
81774	9/16"	8.740	1.138	0.276	0.846	0.366	0.196
81775	5/8"	9.524	1.291	0.303	0.941	0.413	0.273
81776	11/16"	10.232	1.382	0.319	1.016	0.433	0.328
81777	3/4"	10.972	1.551	0.362	1.098	0.476	0.408
81778	13/16"	11.827	1.701	0.390	1.201	0.520	0.525
81779	7/8"	12.520	1.783	0.406	1.264	0.539	0.635
81780	15/16"	13.252	1.945	0.429	1.327	0.579	0.705
81781	1"	14.035	2.024	0.445	1.398	0.598	0.899
81754	6 mm	5.094	0.520	0.161	0.449	0.197	2.053
81755	7 mm	5.445	0.567	0.169	0.484	0.209	2.054
81756	8 mm	5.799	0.654	0.177	0.535	0.217	0.064
81757	9 mm	6.220	0.728	0.185	0.583	0.244	0.090
81758	10 mm	6.543	0.807	0.213	0.634	0.272	0.123
81759	11 mm	7.291	0.894	0.236	0.685	0.295	0.141
81760	12 mm	7.736	0.969	0.244	0.728	0.327	0.176
81761	13 mm	8.114	1.051	0.252	0.780	0.335	0.185
81762	14 mm	8.740	1.138	0.276	0.846	0.366	0.236
81763	15 mm	9.134	1.213	0.291	0.890	0.390	0.287
81764	16 mm	9.524	1.291	0.303	0.941	0.413	0.340
81765	17 mm	10.232	1.382	0.319	1.016	0.433	0.414
81766	18 mm	10.602	1.461	0.339	1.047	0.453	0.428
81767	19 mm	10.972	1.551	0.362	1.098	0.476	0.708

OPEN STOCK

WRENCHES



81903 - 20 Pc. Stubby Combination Non-Ratcheting Wrench Set SAE/METRIC

Item No.	Description
81624	3/8" Stubby Combination Wrench
81625	7/16" Stubby Combination Wrench
81626	1/2" Stubby Combination Wrench
81627	9/16" Stubby Combination Wrench
81628	5/8" Stubby Combination Wrench
81629	11/16" Stubby Combination Wrench

Item No.	Description
81630	3/4" Stubby Combination Wrench
81631	13/16" Stubby Combination Wrench
81632	7/8" Stubby Combination Wrench
81633	15/16" Stubby Combination Wrench
81634	10 mm Stubby Combination Wrench
81635	11 mm Stubby Combination Wrench
81636	12 mm Stubby Combination Wrench
81637	13 mm Stubby Combination Wrench
81638	14 mm Stubby Combination Wrench
81639	15 mm Stubby Combination Wrench
81640	16 mm Stubby Combination Wrench
81641	17 mm Stubby Combination Wrench
81642	18 mm Stubby Combination Wrench
81643	19 mm Stubby Combination Wrench



81905 - 10 Pc. Stubby Combination Non-Ratcheting Wrench Set SAE

Item No.	Description
81624	3/8" Stubby Combination Wrench
81625	7/16" Stubby Combination Wrench
81626	1/2" Stubby Combination Wrench
81627	9/16" Stubby Combination Wrench
81628	5/8" Stubby Combination Wrench
81629	11/16" Stubby Combination Wrench
81630	3/4" Stubby Combination Wrench
81631	13/16" Stubby Combination Wrench
81632	7/8" Stubby Combination Wrench
81633	15/16" Stubby Combination Wrench

SETS
WRENCHES

81904 - 10 Pc. Stubby Combination Non-Ratcheting Wrench Set METRIC

Item No.	Description	
81634	10 mm	Stubby Combination Wrench
81635	11 mm	Stubby Combination Wrench
81636	12 mm	Stubby Combination Wrench
81637	13 mm	Stubby Combination Wrench
81638	14 mm	Stubby Combination Wrench
81639	15 mm	Stubby Combination Wrench
81640	16 mm	Stubby Combination Wrench
81641	17 mm	Stubby Combination Wrench
81642	18 mm	Stubby Combination Wrench
81643	19 mm	Stubby Combination Wrench



Open Stock - Stubby Combination Non-Ratcheting Wrenches SAE/METRIC

Item No.	Opening Inches/Metric	Overall Length (inch) A	Width Open End (inch) B	Thickness Open End (inch) C	Width Box End (inch) D	Thickness Box End (inch) E	Weight (lbs)
81624	3/8"	3.752	0.807	0.634	0.181	0.232	0.066
81625	7/16"	4.067	0.894	0.685	0.197	0.256	0.073
81626	1/2"	4.268	1.051	0.780	0.220	0.303	0.096
81627	9/16"	4.543	1.138	0.846	0.236	0.327	0.126
81628	5/8"	4.862	1.291	0.941	0.260	0.370	0.172
81629	11/16"	5.020	1.382	1.016	0.276	0.390	0.219
81630	3/4"	5.492	1.551	1.098	0.315	0.429	0.267
81631	13/16"	5.752	1.701	1.201	0.339	0.469	0.324
81632	7/8"	6.252	1.783	1.276	0.354	0.488	0.405
81633	15/16"	6.500	1.945	1.327	0.378	0.528	0.477
81634	10 mm	3.752	0.807	0.634	0.181	0.232	0.066
81635	11 mm	4.067	0.894	0.685	0.197	0.256	0.073
81636	12 mm	4.189	0.969	0.728	0.209	0.276	0.089
81637	13 mm	4.268	1.051	0.780	0.220	0.303	0.093
81638	14 mm	4.543	1.138	0.846	0.236	0.327	0.126
81639	15 mm	4.701	1.213	0.890	0.248	0.346	0.146
81640	16 mm	4.862	1.291	0.941	0.260	0.370	0.174
81641	17 mm	5.020	1.382	1.016	0.276	0.390	0.215
81642	18 mm	5.142	1.461	1.047	0.295	0.409	0.243
81643	19 mm	5.492	1.551	1.098	0.315	0.429	0.272



81914 - 3 Pc. Flex Flare Nut Non-Ratcheting Wrench Set SAE

Item No.	Description	
81694	3/8" x 7/16"	Flex Flare Nut Wrench
81695	1/2" x 9/16"	Flex Flare Nut Wrench
81696	5/8" x 11/16"	Flex Flare Nut Wrench

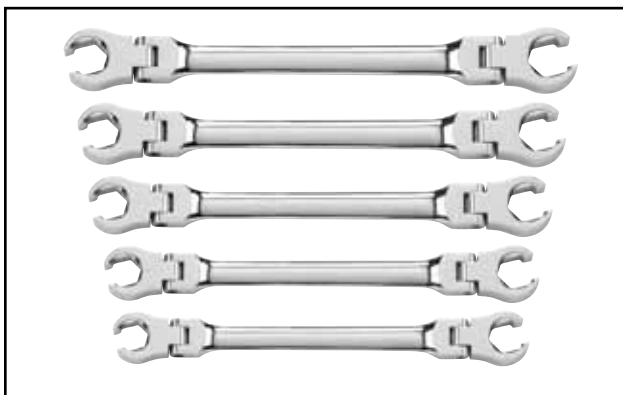

81910 - 5 Pc. Flex Flare Nut Non-Ratcheting Wrench Set SAE

Item No.	Description	
81693	1/4" x 5/16"	Flex Flare Nut Wrench
81694	3/8" x 7/16"	Flex Flare Nut Wrench
81695	1/2" x 9/16"	Flex Flare Nut Wrench
81696	5/8" x 11/16"	Flex Flare Nut Wrench
81697	3/4" x 7/8"	Flex Flare Nut Wrench



81915 - 3 Pc. Flex Flare Nut Non-Ratcheting Wrench Set METRIC

Item No.	Description	
81686	9 x 11 mm	Flex Flare Nut Wrench
81687	10 x 12 mm	Flex Flare Nut Wrench
81688	13 x 14 mm	Flex Flare Nut Wrench



81911 - 6 Pc. Flex Flare Nut Non-Ratcheting Wrench Set METRIC

Item No.	Description	
81686	9 x 11 mm	Flex Flare Nut Wrench
81687	10 x 12 mm	Flex Flare Nut Wrench
81688	13 x 14 mm	Flex Flare Nut Wrench
81689	15 x 17 mm	Flex Flare Nut Wrench
81690	16 x 18 mm	Flex Flare Nut Wrench
81692	19 x 21 mm	Flex Flare Nut Wrench

81907 - 6 Pc. Flare Nut Non-Ratcheting Wrench Set SAE

Item No.	Description
81680	1/4" x 5/16" Flare Nut Wrench
81681	3/8" x 7/16" Flare Nut Wrench
81682	1/2" x 9/16" Flare Nut Wrench
81683	5/8" x 11/16" Flare Nut Wrench
81684	5/8" x 3/4" Flare Nut Wrench
81685	3/4" x 7/8" Flare Nut Wrench



81906 - 6 Pc. Flare Nut Non-Ratcheting Wrench Set METRIC

Item No.	Description
81644	9 x 11 mm Flare Nut Wrench
81645	10 x 12 mm Flare Nut Wrench
81646	13 x 14 mm Flare Nut Wrench
81647	15 x 17 mm Flare Nut Wrench
81648	16 x 18 mm Flare Nut Wrench
81649	19 x 21 mm Flare Nut Wrench



Open Stock - Flare Nut Non-Ratcheting Wrenches SAE/METRIC

Item No.	Opening Inches/Metric	Overall Length (inch) A	Width Open End (inch) B	Thickness Open End (inch) C	Width Open End (inch) D	Thickness Open End (inch) E	Weight (lbs)
81680	1/4" x 5/16"	5.118	0.630	0.681	0.236	0.268	0.077
81681	3/8" x 7/16"	5.984	0.764	0.870	0.323	0.350	0.198
81682	1/2" x 9/16"	7.035	0.980	1.028	0.386	0.409	0.287
81683	5/8" x 11/16"	7.614	1.083	1.197	0.441	0.476	0.359
81684	5/8" x 3/4"	8.287	1.142	1.260	0.457	0.496	0.428
81685	3/4" x 7/8"	8.858	1.323	1.461	0.516	0.539	0.582
81644	9 x 11 mm	5.984	0.764	0.870	0.323	0.350	0.150
81645	10 x 12 mm	6.535	0.827	0.925	0.339	0.370	0.201
81646	13 x 14 mm	7.035	0.980	1.028	0.386	0.409	0.256
81647	15 x 17 mm	7.614	1.083	1.197	0.441	0.476	0.355
81648	16 x 18 mm	8.287	1.142	1.260	0.457	0.496	0.425
81649	19 x 21 mm	8.858	1.323	1.461	0.516	0.539	0.584



Open Stock - Flex Flare Nut Non-Ratcheting Wrenches SAE/METRIC

Item No.	Opening Inches/Metric	Overall Length (inch) A	Width Open End (inch) B	Thickness Open End (inch) C	Width Open End (inch) D	Thickness Open End (inch) E	Weight (lbs)
81693	1/4" x 5/16"	5.709	0.630	0.720	0.256	0.256	0.077
81694	3/8" x 7/16"	7.130	0.772	0.811	0.394	0.394	0.198
81695	1/2" x 9/16"	8.429	0.890	0.953	0.417	0.453	0.287
81696	5/8" x 11/16"	9.303	1.122	1.181	0.453	0.512	0.359
81697	3/4" x 7/8"	11.146	1.252	1.370	0.559	0.579	0.582
81686	9 x 11 mm	6.264	0.732	0.811	0.374	0.394	0.150
81687	10 x 12 mm	7.563	0.772	0.850	0.394	0.417	0.201
81688	13 x 14 mm	8.429	0.890	0.953	0.417	0.453	0.256
81689	15 x 17 mm	9.303	1.122	1.181	0.453	0.512	0.355
81690	16 x 18 mm	10.169	1.122	1.252	0.453	0.559	0.425
81692	19 x 21 mm	11.146	1.465	1.370	0.559	0.579	0.584



81908 - 11 Pc. Crowfoot Drive Non-Ratcheting Wrench Set SAE

Item No.	Description
81603	3/8" Crowfoot Drive Wrench
81604	7/16" Crowfoot Drive Wrench
81605	1/2" Crowfoot Drive Wrench
81606	9/16" Crowfoot Drive Wrench
81607	5/8" Crowfoot Drive Wrench
81608	11/16" Crowfoot Drive Wrench
81609	3/4" Crowfoot Drive Wrench
81610	13/16" Crowfoot Drive Wrench
81611	7/8" Crowfoot Drive Wrench

81612	15/16"	Crowfoot Drive Wrench
81613	1"	Crowfoot Drive Wrench

OPEN STOCK
WRENCHES

81909 - 10 Pc. Crowfoot Drive Non-Ratcheting Wrench Set METRIC

Item No.	Description	
81614	10 mm	Crowfoot Drive Wrench
81615	11 mm	Crowfoot Drive Wrench
81616	12 mm	Crowfoot Drive Wrench
81617	13 mm	Crowfoot Drive Wrench
81618	14 mm	Crowfoot Drive Wrench
81619	15 mm	Crowfoot Drive Wrench
81620	16 mm	Crowfoot Drive Wrench
81621	17 mm	Crowfoot Drive Wrench



81622	18 mm	Crowfoot Drive Wrench
81623	19 mm	Crowfoot Drive Wrench

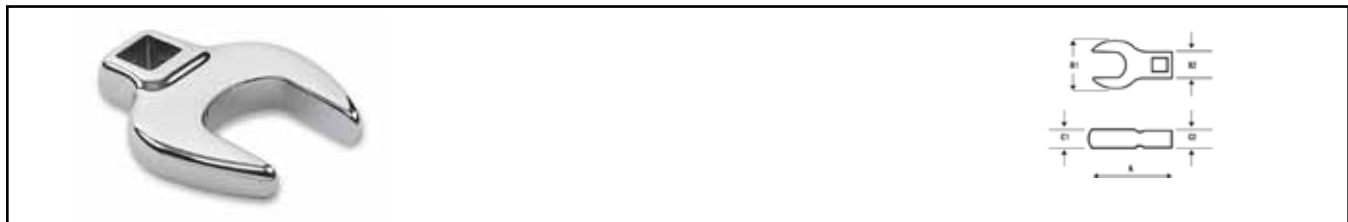

Open Stock - Crowfoot Non-Ratcheting Wrenches SAE/METRIC

Item No.	Opening Inches/Metric	Overall Length (inch) A	Width Open End (inch) B	Thickness Open End (inch) C	Width Open End (inch) D	Thickness Open End (inch) E	Weight (lbs)
81603	3/8"	1.299	0.866	0.709	0.118	0.236	0.044
81604	7/16"	1.378	0.945	0.709	0.118	0.236	0.044
81605	1/2"	1.417	1.024	0.709	0.157	0.236	0.044
81606	9/16"	1.535	1.142	0.709	0.157	0.236	0.088
81607	5/8"	1.614	1.260	0.709	0.236	0.236	0.088
81608	11/16"	1.772	1.378	0.709	0.236	0.236	0.088
81609	3/4"	1.890	1.575	0.866	0.236	0.394	0.132
81610	13/16"	2.047	1.732	1.023	0.276	0.394	0.176
81611	7/8"	2.204	1.819	1.023	0.315	0.394	0.220
81612	15/16"	2.361	2.046	1.180	0.354	0.394	0.264
81613	1"	2.518	2.203	1.337	0.393	0.394	0.290
81614	10 mm	1.300	0.906	0.709	0.118	0.236	0.770
81615	11 mm	1.380	0.906	0.709	0.118	0.236	0.770
81616	12 mm	1.378	0.906	0.709	0.118	0.236	0.044
81617	13 mm	1.417	1.024	0.709	0.118	0.236	0.044
81618	14 mm	1.570	1.100	0.709	0.118	0.236	0.090
81619	15 mm	1.654	1.260	0.709	0.236	0.394	0.088
81620	16 mm	1.654	1.260	0.709	0.236	0.394	0.088
81621	17 mm	1.772	1.378	0.709	0.276	0.394	0.088
81622	18 mm	1.772	1.378	0.709	0.236	0.394	0.132
81623	19 mm	1.969	1.575	0.748	0.236	0.394	0.132



81926 - 5 Pc. 30 Degree Deep Offset Box Non-Ratcheting Wrench Set SAE

Item No.	Description	
81787	3/8 X 1"	30 Degree Deep Offset Box Wrench
81788	1/2" x 9/16"	30 Degree Deep Offset Box Wrench
81789	11/16 X 3/4"	30 Degree Deep Offset Box Wrench
81790	13/16 X 7/8"	30 Degree Deep Offset Box Wrench
81791	15/16 X 1"	30 Degree Deep Offset Box Wrench



81927 - 5 Pc. 30 Degree Deep Offset Box Non-Ratcheting Wrench Set METRIC

Item No.	Description	
81782	8 x 10 mm	30 Degree Deep Offset Box Wrench
81783	10 x 12 mm	30 Degree Deep Offset Box Wrench
81784	11 X 13 mm	30 Degree Deep Offset Box Wrench
81785	12 x 14 mm	30 Degree Deep Offset Box Wrench
81786	17 x 19 mm	30 Degree Deep Offset Box Wrench



Open Stock - 30 Degree Deep Offset Box Non-Ratcheting Wrenches SAE

Item No.	Opening Inches/Metric	Overall Length (inch) A	Width Open End (inch) B	Width Open End (inch) D	Weight (lbs)
81787	3/8" x 1"	7.677	0.640	0.724	0.185
81788	1/2" x 9/16"	8.661	0.778	0.856	0.449
81789	11/16" x 3/4"	9.843	1.047	1.093	1.100
81790	13/16" x 7/8"	11.417	1.211	1.309	0.189
81791	15/16" x 1"	14.173	1.343	1.467	0.491
81782	8 x 10 mm	7.283	0.561	0.640	0.185
81783	10 x 12 mm	7.677	0.640	0.724	0.449
81784	11 x 13 mm	8.071	0.724	0.817	1.100
81785	12 x 14 mm	8.661	0.778	0.856	0.189
81786	17 x 19 mm	9.843	1.047	1.093	0.491

81929 - 7 Pc. Full Polish Open End Non-Ratcheting Wrench Set SAE

Item No.	Description	
81798	1/4 X 5/16"	Full Polish Open End Wrench
81799	3/8" x 7/16"	Full Polish Open End Wrench
81801	1/2 X 9/16"	Full Polish Open End Wrench
81802	5/8 X 11/16"	Full Polish Open End Wrench
81803	13/16 X 3/4"	Full Polish Open End Wrench
81804	15/16" x 1"	Full Polish Open End Wrench
81805	1-1/8 X 1-1/4"	Full Polish Open End Wrench



81928 - 6 Pc. Full Polish Open End Non-Ratcheting Wrench Set METRIC

Item No.	Description	
81792	6 x 7 mm	Full Polish Open End Wrench
81793	8 x 10 mm	Full Polish Open End Wrench
81794	10 x 12 mm	Full Polish Open End Wrench
81795	11 x 13 mm	Full Polish Open End Wrench
81796	12 x 14 mm	Full Polish Open End Wrench
81797	17 x 19 mm	Full Polish Open End Wrench



Open Stock - Full Polish Open End Non-Ratcheting Wrenches SAE

Item No.	Opening Inches/Metric	Overall Length (inch) A	Width Open End (inch) B	Thickness Open End (inch) C	Width Open End (inch) D	Thickness Open End (inch) E	Weight (lbs)
81798	1/4" x 5/16"	4.882	0.494	0.130	0.658	0.146	0.185
81799	3/8" x 7/16"	5.902	0.822	0.173	0.905	0.189	0.449
81801	1/2" x 9/16"	6.925	1.069	0.213	1.152	0.228	1.010
81802	5/8" x 11/16"	7.945	1.316	0.252	1.399	0.268	0.189
81803	13/16" x 3/4"	8.965	1.399	0.268	1.563	0.307	0.491
81804	15/16" x 1"	11.008	1.974	0.366	2.057	0.382	0.524
81805	1-1/8" x 1-1/4"	12.205	2.468	0.445	2.632	0.461	0.615
81792	6 x 7 mm	4.862	0.494	0.130	0.658	0.146	0.185
81793	8 x 10 mm	5.882	0.658	0.217	0.822	0.217	0.449
81794	10 x 12 mm	6.390	0.822	0.232	0.988	0.232	1.100
81795	11 x 13 mm	6.858	0.905	0.244	1.069	0.244	0.189
81796	12 x 14 mm	7.327	0.988	0.260	1.152	0.260	0.491
81797	17 x 19 mm	8.917	1.399	0.268	1.563	0.307	0.524



81990 - 3 Pc. Adjustable Cushion Grip Non-Ratcheting Wrench Set

Item No.	Description	
81890	6"	Adjustable Cushion Grip Wrench
81891	8"	Adjustable Cushion Grip Wrench
81892	10"	Adjustable Cushion Grip Wrench



Open Stock - Adjustable Cushion Grip Wrenches

Item No.	Overall Length (inch)	Capacity (inch)	Weight (lbs)
81890	7.000"	0.750	0.304
81891	9.000"	0.938	0.622
81892	11.000"	1.125	1.016
81893	13.000"	1.312	1.600



81992 - 3 Pc. Adjustable Non-Ratcheting Wrench Set

Item No.	Description	
81881	6"	Adjustable Wrench
81882	8"	Adjustable Wrench
81883	10"	Adjustable Wrench



81991 - 3 Pc. Large Adjustable Non-Ratcheting Wrench Set

Item No.	Description	
81884	12"	Large Adjustable Wrench
81885	15"	Large Adjustable Wrench
81886	18"	Large Adjustable Wrench

SETS
WRENCHES

Open Stock Chrome Adjustable Wrenches

Item No.	Overall Length (inch)	Capacity (inch)	Weight (lbs)
81880	6.2"	0.750	0.100
81881	6.200"	0.750	0.599
81882	8.200"	0.938	0.599
81883	10.100"	1.125	1.000
81884	12.100"	1.312	1.400
81885	15.000"	1.500	2.800
81886	18.100"	1.750	2.800
81887	24.100"	2.000	4.400



81993 - 3 Pc. Black Adjustable Non-Ratcheting Wrench Set

Item No.	Description
81874	12" Black Adjustable Wrench
81875	15" Black Adjustable Wrench
81876	18" Black Adjustable Wrench



Open Stock - Black Adjustable Wrenches

Item No.	Overall Length (inch)	Capacity (inch)	Weight (lbs)
81870	4.600	0.650	0.100
81871	6.200	0.750	0.599
81872	8.200	0.938	0.600
81873	10.100	1.125	1.000
81874	12.100	1.312	1.400
81875	15.000	1.500	2.800
81876	18.100	1.750	2.800
81877	24.100	2.000	4.400



OPEN STOCK

WRENCHES

TORQUE WRENCHES

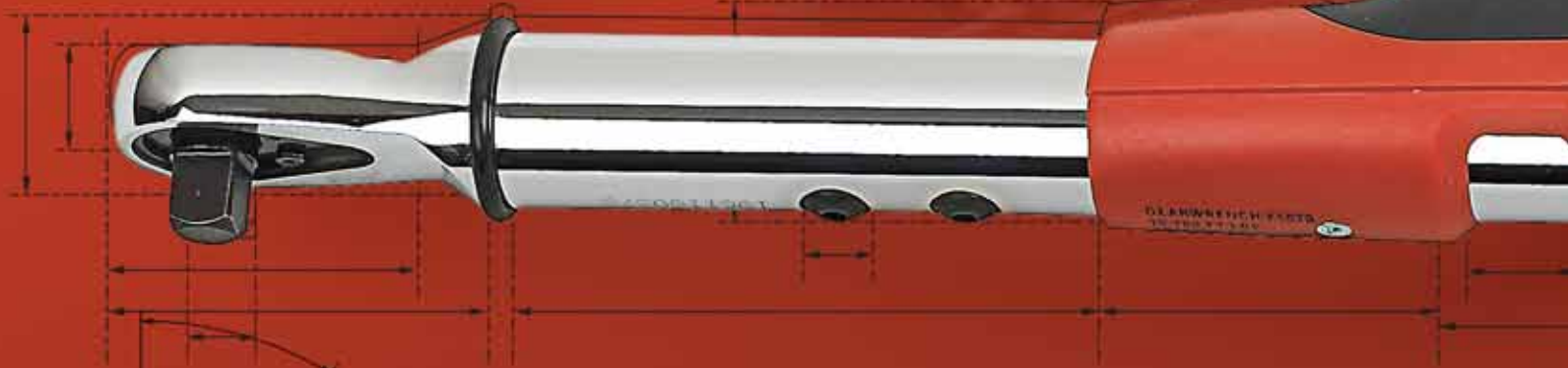
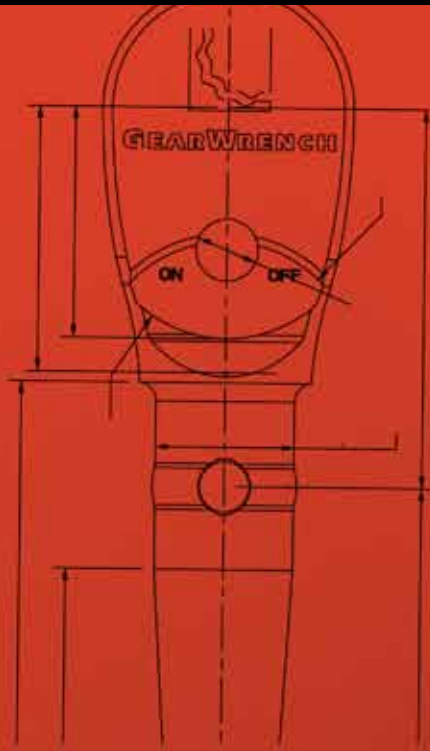

Torque Wrenches

Electronic Torque Wrenches

Micrometer Torque Wrenches

Tire Pressure Monitoring System Kit

ELECTRONIC TORQUE WRENCHES WITH ANGLE



Sealed design guards against dirt infiltration

Backlit LCD Screen makes reading torque and angle values quick and easy



Digitally tracks torque and angle measurements. Buzzer with Red, Yellow and Green lights alerts you when targets are reached.

Shock-resistant housing provides durability



Thin-profile, high-strength teardrop head flexes for easier access and features a 60-tooth gear with 6° ratcheting arc

Torque Accuracy: +/- 2% CW, +/- 3% CCW from 20% to 100% full scale.
Angle Accuracy: +/- 1% of reading

Knurled Aluminum Grip resists slipping

MICROMETER TORQUE WRENCHES

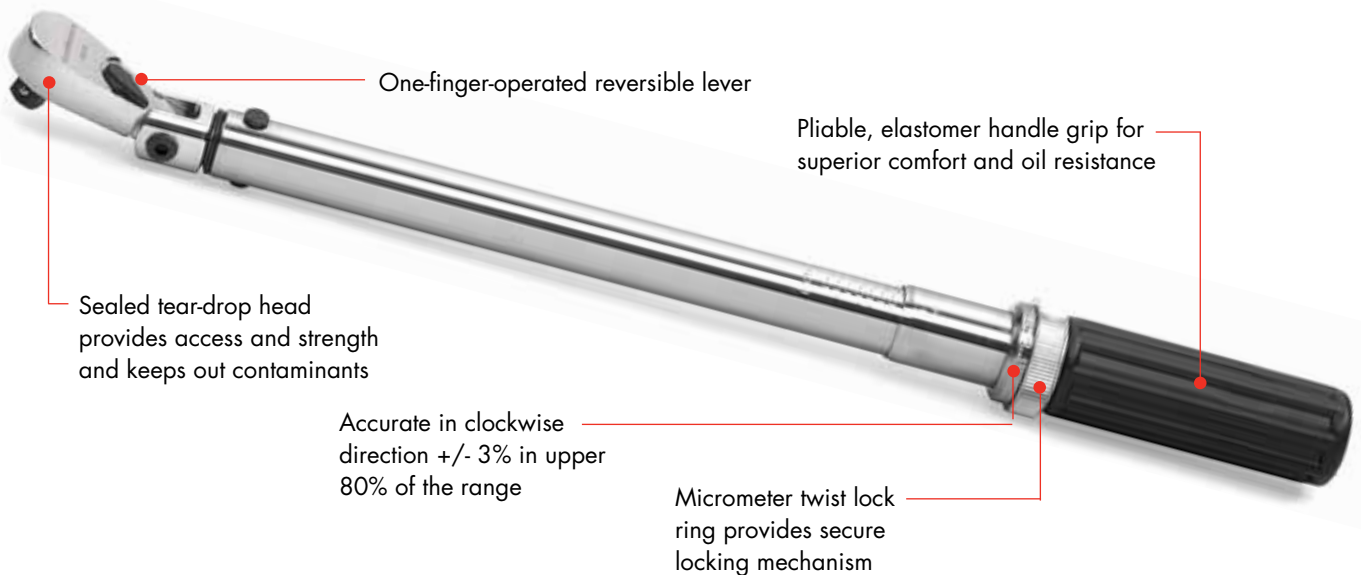

One-finger-operated reversible lever

Pliable, elastomer handle grip for superior comfort and oil resistance

Sealed tear-drop head provides access and strength and keeps out contaminants

Accurate in clockwise direction +/- 3% in upper 80% of the range

Micrometer twist lock ring provides secure locking mechanism

TORQUE WRENCHES

Electronic Flex Head Torque Wrench with Angle

Item No.	Drive Size	Torque Range	Weight (lbs)
85073	3/8"	10 - 100 in/lbs	2.1
85074	1/2"	25 - 250 in/lbs	3.4



Electronic Torque Wrench]

Item No.	Drive Size	Torque Range	Weight (lbs)
85070	3/8"	10 - 100 ft/lbs	3.2
85071	1/2"	25 - 250 ft/lbs	4.8



Flex Head Micrometer Torque Wrench

Item No.	Drive Size	Torque Range	Weight (lbs)
85056	3/8"	5 - 75 ft/lbs	2.3
85057	1/2"	25 - 250 ft/lbs	3.6

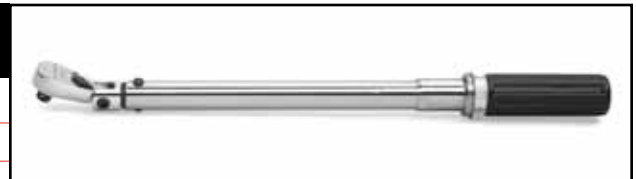

85050 - Micrometer Torque Wrench 1/4" Drive

Torque Range	Weight (lbs)
30 - 200 in/lbs	1.35



3/8" Drive - Micrometer Torque Wrench

Item No.	Torque Range	Weight (lbs)
85051	25 - 250 in/lbs	2.5
85052	10 - 100 ft/lbs	3.2

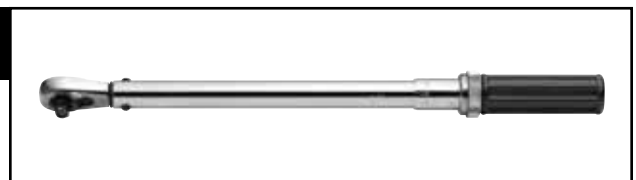

1/2" Drive - Micrometer Torque Wrench

Item No.	Torque Range	Weight (lbs)
85053	20 - 150 ft/lbs	4.2
85054	20 - 250 ft/lbs	5



85055 - Micrometer Torque Wrench 3/4" Drive

Torque Range	Weight (lbs)
100 - 600 ft/lbs	16

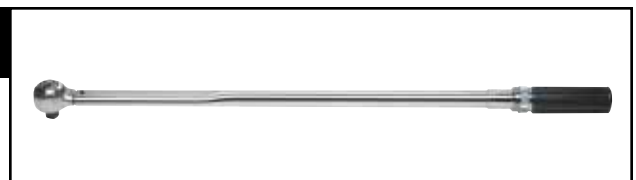



85075 - 4 Pc. Tire Pressure Monitoring System Kit

Item No.	Description
80147	12mm 6 Pt. Deep Socket 1/4" Drive
80146	11mm 6 Pt. Deep Socket 1/4" Drive
KDS3968	Valve Stem Torque Tool
85072	1/4" Drive Electronic Torque Wrench



85072 - Electronic Torque Wrench 1/4" Drive

Torque Range	Weight (lbs)
12 - 120 in/lbs	1.5

SCREWDRIVERS & NUTDRIVERS



Screwdrivers & Nutdrivers

Dual Material Screwdrivers
Solid Handle Screwdrivers
Cushion Grip Screwdrivers

Insulated Screwdrivers
Nutdrivers
Insulated Nutdrivers

Ratcheting Screwdrivers

Standard Ratcheting
Stubby Ratcheting

T-Handle Ratcheting
Ratcheting Nutdrivers



**DUAL MATERIAL
SCREWDRIVERS**

- AVAILABLE IN:**
- Phillips
 - Slotted
 - Torx®
 - Pozidrive®

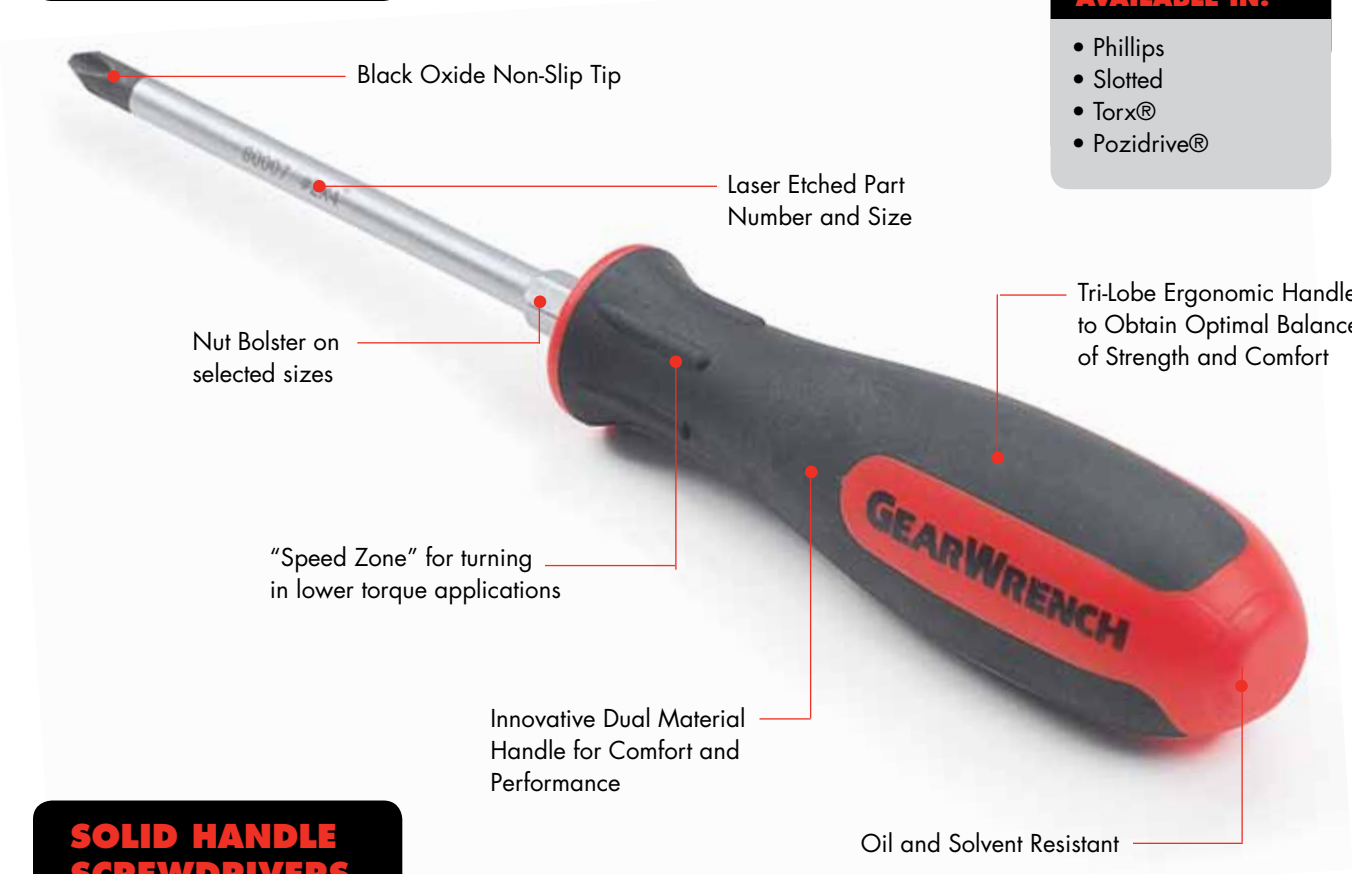

**SOLID HANDLE
SCREWDRIVERS**





Rated to 1,000 Volts

Dual Material Grip for Comfort and Performance

**INSULATED
SCREWDRIVERS**

Black Oxide Non-Slip Tip

**MINI
SCREWDRIVERS**



"Speed Zone" for turning in lower torque applications

Black Oxide Non-Slip Tip

Innovative Dual Material Handle for Comfort and Performance

- AVAILABLE IN:**
- Phillips
 - Slotted
 - Torx®

Cap color indicates tip style

- Black - Phillips
- Red - Slotted
- Grey - Torx®

**RATCHETING
SCREWDRIVERS**



Interchangeable shafts allow access to nearly any fastener

8° Reversible Ratcheting mechanism, Ratcheting or Non-ratcheting mode

Dual durometer ergonomic shape handle helps reduce fatigue and improve grip and high torque

- AVAILABLE IN:**
- Standard
 - T-Handle
 - Stubby

Removable end cap allows convenient storage for up to 12 bits

Products are covered by one or more of the following patents:
 • US 7,137,320



80066 - 20 Pc. Master Dual Material Screwdriver Set

Item No.	Description
80012	1/4" x 1-1/2" Slotted Screwdriver
80018	3/16" x 6" Slotted Screwdriver
80013	1/4" x 4" Slotted Screwdriver
80014	1/4" x 6" Slotted Screwdriver
80023	5/16" x 6" Slotted Screwdriver
80022	3/8" x 8" Slotted Screwdriver
80000	#0 x 2-1/2" Phillips Screwdriver
80001	#1 x 3" Phillips Screwdriver
80004	#1 x 6" Phillips Screwdriver
80005	#2 x 1-1/2" Phillips Screwdriver
80007	#2 x 4" Phillips Screwdriver
80011	#3 x 6" Phillips Screwdriver
80034	1.5mm Mini Slotted Screwdriver
80035	2.0mm Mini Slotted Screwdriver
80036	2.5mm Mini Slotted Screwdriver
80031	#00 Mini Phillips Screwdriver
80032	#0 Mini Phillips Screwdriver
80033	#1 Mini Phillips Screwdriver
80025	T-15 Torx® Screwdriver
80026	T-20 Torx® Screwdriver

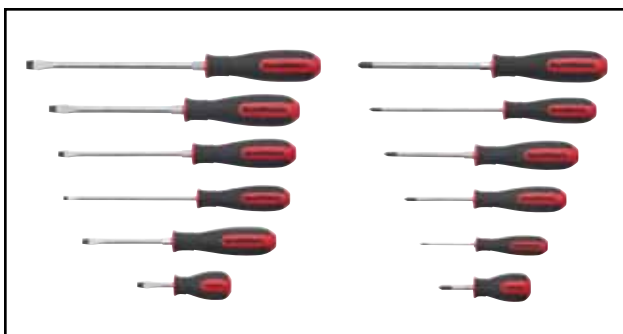

80051 - 12 Pc. Combination Dual Material Screwdriver Set

Item No.	Description
80012	1/4" x 1-1/2" Slotted Screwdriver
80018	3/16" x 6" Slotted Screwdriver
80013	1/4" x 4" Slotted Screwdriver
80014	1/4" x 6" Slotted Screwdriver
80023	5/16" x 6" Slotted Screwdriver
80022	3/8" x 8" Slotted Screwdriver
80000	#0 x 2-1/2" Phillips Screwdriver
80001	#1 x 3" Phillips Screwdriver
80004	#1 x 6" Phillips Screwdriver
80005	#2 x 1-1/2" Phillips Screwdriver
80007	#2 x 4" Phillips Screwdriver
80011	#3 x 6" Phillips Screwdriver

80050 - 6 Pc. Combination Dual Material Screwdriver Set

Item No.	Description
80015	1/8" x 3" Slotted Screwdriver
80013	1/4" x 4" Slotted Screwdriver
80023	5/16" x 6" Slotted Screwdriver
80022	3/8" x 8" Slotted Screwdriver
80001	#1 x 3" Phillips Screwdriver
80007	#2 x 4" Phillips Screwdriver



80052 - 5 Pc. Phillips Dual Material Screwdriver Set

Item No.	Description
80000	#0 x 2-1/2" Phillips Screwdriver
80001	#1 x 3" Phillips Screwdriver
80007	#2 x 4" Phillips Screwdriver
80010	#2 x 8" Phillips Screwdriver
80011	#3 x 6" Phillips Screwdriver



80053 - 5 Pc. Slotted Dual Material Screwdriver Set

Item No.	Description
80015	1/8" x 3" Slotted Screwdriver
80013	1/4" x 4" Slotted Screwdriver
80014	1/4" x 6" Slotted Screwdriver
80023	5/16" x 6" Slotted Screwdriver
80022	3/8" x 8" Slotted Screwdriver



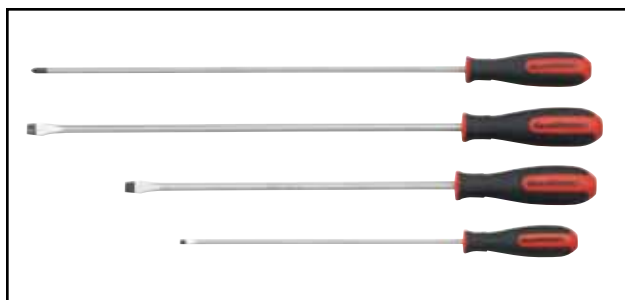

80059 - 4 Pc. Long Dual Material Screwdriver Set

Item No.	Description
80021	3/8" x 16" Long Slotted Screwdriver
80019	3/16" x 10" Long Slotted Screwdriver
80020	3/8" x 12" Long Slotted Screwdriver
80006	#2 x 16" Long Phillips Screwdriver



80054 - 7 Pc. Torx® Dual Material Screwdriver Set

Item No.	Description
80024	T-10 Torx® Screwdriver
80025	T-15 Torx® Screwdriver
80026	T-20 Torx® Screwdriver
80027	T-25 Torx® Screwdriver
80028	T-27 Torx® Screwdriver
80029	T-30 Torx® Screwdriver
80030	T-40 Torx® Screwdriver

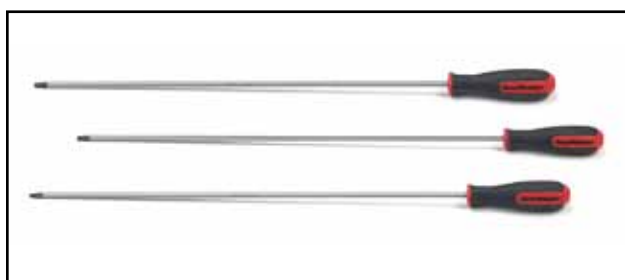

80064 - 3 Pc. Long Torx® Dual Material Screwdriver Set

Item No.	Description
80086	T-15 Long Torx® Screwdriver 18"
80087	T-20 Long Torx® Screwdriver 18"
80088	T-25 Long Torx® Screwdriver 18"

80057 - 12 Pc. Combination Mini Dual Material Screwdriver Set

Item No.	Description
80034	1.5mm Mini Slotted Screwdriver
80035	2.0mm Mini Slotted Screwdriver
80036	2.5mm Mini Slotted Screwdriver
80031	#00 Mini Phillips Screwdriver
80032	#0 Mini Phillips Screwdriver
80033	#1 Mini Phillips Screwdriver
80037	T-5 Mini Torx® Screwdriver
80038	T-6 Mini Torx® Screwdriver
80039	T-7 Mini Torx® Screwdriver
80040	T-8 Mini Torx® Screwdriver
80041	T-9 Mini Torx® Screwdriver
80042	T-10 Mini Torx® Screwdriver



80055 - 6 Pc. Mini Dual Material Screwdriver Set

Item No.	Description
80034	1.5mm Mini Slotted Screwdriver
80035	2.0mm Mini Slotted Screwdriver
80036	2.5mm Mini Slotted Screwdriver
80031	#00 Mini Phillips Screwdriver
80032	#0 Mini Phillips Screwdriver
80033	#1 Mini Phillips Screwdriver

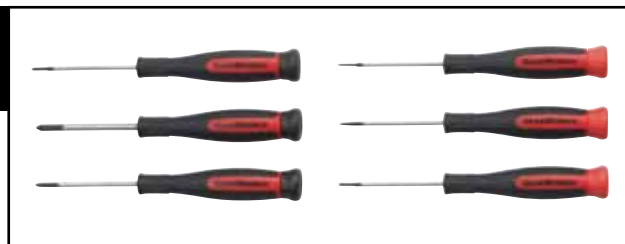

80056 - 6 Pc. Mini Torx® Dual Material Screwdriver Set

Item No.	Description
80037	T-5 Mini Torx® Screwdriver
80038	T-6 Mini Torx® Screwdriver
80039	T-7 Mini Torx® Screwdriver
80040	T-8 Mini Torx® Screwdriver
80041	T-9 Mini Torx® Screwdriver
80042	T-10 Mini Torx® Screwdriver

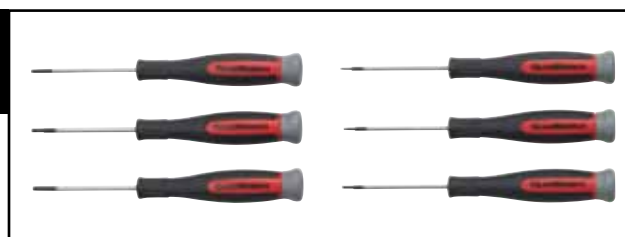



80060 - 10 Pc. Combination and Pozidriv® Dual Material Screwdriver Set

Item No.	Description
80043	#0 x 2-1/2" Pozidriv® Screwdriver
80044	#1 x 3" Pozidriv® Screwdriver
80045	#2 x 4" Pozidriv® Screwdriver
80046	#3 x 6" Pozidriv® Screwdriver
80015	1/8" x 3" Slotted Screwdriver
80017	3/16" x 4" Slotted Screwdriver
80013	1/4" x 4" Slotted Screwdriver
80023	5/16" x 6" Slotted Screwdriver
80001	#1 x 3" Phillips Screwdriver
80007	#2 x 4" Phillips Screwdriver



80061 - 4 Pc. Pozidriv® Dual Material Screwdriver Set

Item No.	Description
80043	#0 x 2-1/2" Pozidriv® Screwdriver
80044	#1 x 3" Pozidriv® Screwdriver
80045	#2 x 4" Pozidriv® Screwdriver
80046	#3 x 6" Pozidriv® Screwdriver



80065 - 4 Pc. Square Dual Material Screwdriver Set

Item No.	Description
80089	# 0 x 8.25" Square Screwdriver
80090	#1 x 8.75" Square Screwdriver
80091	#2 x 8.75" Square Screwdriver
80092	# 3 x 10" Square Screwdriver

Open Stock - Dual Material Screwdrivers Slotted



Item No.	Description	Tip Thickness (inch) A	Tip Width (inch) B	Blade Length (inch) C	Blade Dia. (inch) D	Overall Length (inch) E	Handle Size (D x L)(inch) F	Weight (lbs)
80015	1/8" x 3"	0.022	0.125	2.968	0.117	6.227	0.893 x 3.223	0.080
80017	3/16" x 4"	0.033	0.187	3.996	0.196	8.125	1.153 x 4.148	0.150
80018	3/16" x 6"	0.033	0.187	5.891	0.196	10.050	1.166 x 4.150	0.160
80019	3/16" x 10"	0.033	0.187	10.125	0.195	14.170	1.170 x 4.151	0.220
80012	1/4" x 1-1/2"	0.040	0.250	1.533	0.236	4.101	1.310 x 2.564	0.120
80013	1/4" x 4"	0.040	0.250	4.070	0.238	8.700	1.310 x 4.615	0.220
80014	1/4" x 6"	0.040	0.025	6.015	0.237	10.625	1.298 x 4.620	0.250
80023	5/16" x 6"	0.046	0.312	6.120	0.315	13.140	1.454 x 5.130	0.380
80022	3/8" x 8"	0.055	0.375	8.050	0.315	13.140	1.426 x 5.126	0.430
80020	3/8" x 12"	0.055	0.375	11.900	0.315	16.950	1.442 x 5.129	0.510
80021	3/8" x 16"	0.055	0.375	15.75	0.315	20.900	1.450 x 5.116	0.550

Open Stock - Dual Material Screwdrivers PHILLIPS



Item No.	Size	Blade Length (inch) A	Blade Dia. (inch) B	Overall Length (inch) C	Handle Size (D x L)(inch) D	Weight (lbs)
80000	#0 x 2-1/2"	2.507	0.118	5.768	0.912 x 3.264	0.075
80001	#1 x 3"	2.972	0.196	7.127	1.174 x 4.157	0.150
80004	#1 x 6"	5.907	0.195	10.090	1.163 x 4.160	0.160
80005	#2 x 1-1/2"	1.521	0.236	4.094	1.310 x 2.564	0.120
80007	#2 x 4"	4.082	0.237	8.700	1.295 x 4.620	0.220
80009	#2 x 6"	6.006	0.237	10.675	1.280 x 4.604	0.240
80010	#2 x 8"	7.877	0.235	12.500	1.284 x 4.620	0.280
80006	#2 x 16"	16.250	0.236	20.400	1.298 x 4.62	0.440
80011	#3 x 6"	6.071	0.315	11.200	1.452 x 5.125	0.360

Open Stock - Dual Material Screwdrivers TORX®



Item No.	Size	Blade Length (inch) A	Blade Dia. (inch) B	Overall Length (inch) C	Handle Size (D x L)(inch) D	Weight (lbs)
80024	T-10	3.952	0.196	8.100	1.159 x 4.141	0.160
80025	T-15	3.959	0.196	8.100	1.160 x 4.146	0.160
80026	T-20	3.927	0.196	8.100	1.165 x 4.152	0.160
80027	T-25	3.967	0.235	8.600	1.304 x 4.614	0.220
80028	T-27	3.960	0.235	8.575	1.301 x 4.614	0.220
80029	T-30	3.964	0.235	8.580	1.307 x 4.615	0.220
80030	T-40	3.910	0.235	8.525	1.297 x 4.615	0.240
80086	T-15	17.937	0.195	22.000	1.142 x 4.147	0.600
80087	T-20	18.168	0.195	22.315	1.174 x 4.147	0.600
80088	T-25	17.413	0.235	22.015	1.305 x 4.602	0.600

Open Stock - Dual Material Screwdrivers POZIDRIV®

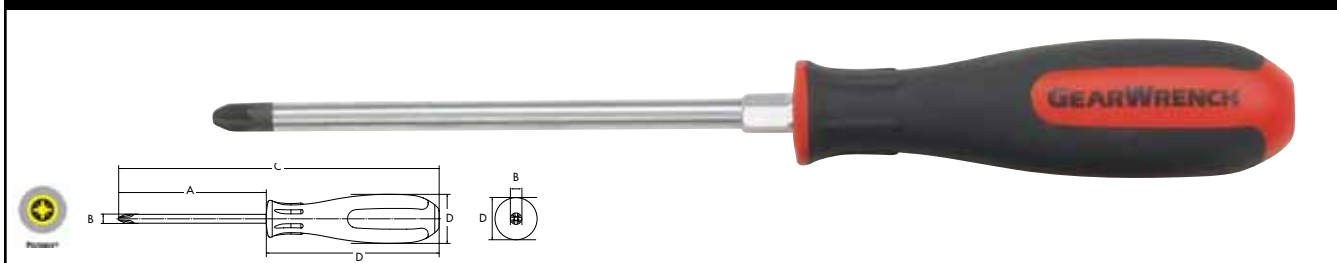

Item No.	Size	Blade Length (inch) A	Blade Dia. (inch) B	Overall Length (inch) C	Handle Size (D x L)(inch) D	Weight (lbs)
80043	#0 x 2-1/2"	2.553	0.118	5.757	.898 x 3.243	0.080
80044	#1 x 3"	3.011	0.196	7.167	1.170 x 4.151	0.150
80045	#2 x 4"	3.921	0.237	8.550	1.303 x 4.621	0.220
80046	#3 x 6"	5.921	0.315	11.050	1.420 x 5.113	0.360

Torx® is a registered trademark of Acument Intellectual Properties, LLC.

SCREWDRIVERS OPEN STOCK

Open Stock - Dual Material Screwdrivers SQUARE



Item No.	Size	Blade Length (inch) A	Blade Dia. (inch) B	Overall Length (inch) C	Handle Size (D x L)(inch) D	Weight (lbs)
80089	# 0 x 8.25"	3.961	0.196	8.100	1.170 x 4.148	0.250
80090	# 1 x 8.75"	3.970	0.235	8.575	1.289 x 4.607	0.250
80091	# 2 x 8.75"	3.953	0.235	8.575	1.303 x 4.606	0.250
80092	# 3 x 10"	4.917	0.315	10.05	1.450 x 5.125	0.250

Open Stock - Mini Dual Material Screwdrivers SLOTTED



Item No.	Size	Tip Width (inch) A	Blade Length (inch) B	Blade Dia. (inch) C	Overall Length (inch) D	Handle Size (D x L)(inch) E	Weight (lbs)
80034	1.5 mm	0.059	2.395	0.097	6.110	.758 x 3.713	0.060
80035	2.0 mm	0.078	2.397	0.097	6.111	.758 x 3.713	0.060
80036	2.5 mm	0.098	2.387	0.980	6.118	.758 x 3.713	0.060

Open Stock - Mini Dual Material Screwdrivers PHILLIPS



Item No.	Size	Blade Length (inch) A	Blade Dia. (inch) B	Overall Length (inch) C	Handle Size (D x L)(inch) D	Weight (lbs)
80031	#00	2.4	0.098	6.116	.748 x 3.708	0.060
80032	#0	2.394	0.118	6.109	.758 x 3.713	0.060
80033	#1	2.394	0.157	6.106	.758 x 3.713	0.060

Open Stock - Mini Dual Material Screwdrivers TORX®



Item No.	Size	Blade Length (inch) A	Blade Dia. (inch) B	Overall Length (inch) C	Handle Size (D x L)(inch) D	Weight (lbs)
80038	T-6	2.370	0.098	6.083	.759" x 3.715	0.060
80037	T-5	2.365	0.098	6.084	.758" x 3.715	0.060
80042	T-10	2.359	0.117	6.083	.756" x 3.715	0.062
80041	T-9	2.360	0.117	6.084	.757" x 3.719	0.062
80040	T-8	2.366	0.097	6.084	.752" x 3.715	0.060
80039	T-7	2.372	0.098	6.087	.758" x 3.715	0.060



82730 - 19 Pc. Combination Solid Handle Screwdriver Set

Item No.	Description
82700	1/8" x 2" Pocket Screwdriver
82701	1/8" x 4" Slotted Screwdriver with Cabinet Tip
82702	3/16" x 6" Slotted Screwdriver
82703	5/16" x 6" Slotted Screwdriver
82704	3/16" x 4" Slotted Screwdriver
82705	1/4" x 1-1/2" Slotted Stubby Screwdriver
82706	1/4" x 4" Slotted Screwdriver
82708	3/8" x 8" Slotted Screwdriver
82710	3/8" x 12" Slotted Screwdriver
82711	3/16" x 4" Slotted Screwdriver with Cabinet Tip
82712	3/16" x 8" Cabinet Tip Screwdriver
82713	#0 2-1/2" Phillips Screwdriver
82715	#1 x 3" Phillips Screwdriver
82716	#2 x 1-1/2" Phillips Screwdriver
82717	#2 x 4" Phillips Screwdriver
82718	#2 x 6" Phillips Screwdriver
82719	#2 x 8" Phillips Screwdriver
82720	#3 x 6" Phillips Screwdriver
82721	#4 x 8" Phillips Screwdriver



Torx® is a registered trademark of Acument Intellectual Properties, LLC.

SCREWDRIVERS OPEN STOCK

82731 - 10 Pc. Combination Solid Handle Screwdriver Set

Item No.	Description
82703	5/16" x 6 Slotted Screwdriver
82704	3/16" x 4 Slotted Screwdriver
82705	1/4" x 1-1/2 Slotted Stubby Screwdriver
82706	1/4" x 4 Slotted Screwdriver
82708	3/8" x 8 Slotted Screwdriver
82715	#1 x 3 Phillips Screwdriver
82716	#2 x 1-1/2 Phillips Screwdriver
82717	#2 x 4 Phillips Screwdriver
82720	#3 x 6 Phillips Screwdriver
82721	#4 x 8 Phillips Screwdriver



82734 - 8 Pc. Combination Solid Handle Screwdriver Set

Item No.	Description
82700	1/8" x 2 Pocket Screwdriver
82701	1/8" x 4 Slotted Screwdriver with Cabinet Tip
82702	3/16" x 6 Slotted Screwdriver
82706	1/4" x 4 Slotted Screwdriver
82713	#0 2-1/2 Phillips Screwdriver
82715	#1 x 3 Phillips Screwdriver
82717	#2 x 4 Phillips Screwdriver
82718	#2 x 6 Phillips Screwdriver



82732 - 6 Pc. Slotted Solid Handle Screwdriver Set

Item No.	Description
82703	5/16" x 6 Slotted Screwdriver
82704	3/16" x 4 Slotted Screwdriver
82705	1/4" x 1-1/2 Slotted Stubby Screwdriver
82706	1/4" x 4 Slotted Screwdriver
82708	3/8" x 8 Slotted Screwdriver
82710	3/8" x 12 Slotted Screwdriver





82733 - 6 Pc. Phillips Solid Handle Screwdriver Set

Item No.	Description
82713	#0 2-1/2 Phillips Screwdriver
82715	#1 x 3 Phillips Screwdriver
82716	#2 x 1-1/2 Phillips Screwdriver
82717	#2 x 4 Phillips Screwdriver
82720	#3 x 6 Phillips Screwdriver
82721	#4 x 8 Phillips Screwdriver



Open Stock - Solid Handle Square Shank Screwdrivers *SLOTTED*



Item No.	Size	Tip Thickness (inch) A	Tip Width (inch) B	Blade Length (inch) C	Blade Dia. (inch) D	Overall Length (inch) E	Handle Size (D x L)(inch) F	Weight (lbs)
82700	1/8" x 2"	0.020	0.120	2.015	0.118	4.800	0.860 x 2.76	0.050
82702	3/16" x 6"	0.030	0.190	6.015	0.197	10.000	1.220 x 3.94	0.176
82704	3/16" x 4"	0.030	0.190	4.070	0.197	8.000	1.220 x 3.94	0.159
82705	1/4" x 1-1/2"	0.040	0.250	1.533	0.236	4.120	1.290 x 2.56	0.125
82706	1/4" x 4"	0.040	0.250	4.070	0.236	8.400	1.340 x 4.33	0.221
82707	1/4" x 6"	0.040	0.250	6.015	0.236	10.400	1.340 x 4.33	0.246
82703	5/16" x 6"	0.050	0.310	6.015	0.315	10.800	1.470 x 4.72	0.362
82708	3/8" x 8"	0.060	0.380	8.050	0.315	12.800	1.470 x 4.72	0.505
82710	3/8" x 12"	0.060	0.380	11.900	0.315	16.800	1.470 x 4.72	0.627
82709	5/16" x 18"	0.050	0.310	17.973	0.315	22.800	1.470 x 4.72	0.750

SCREWDRIVERS OPEN STOCK

Open Stock - Solid Handle Screwdrivers CABINET TIP

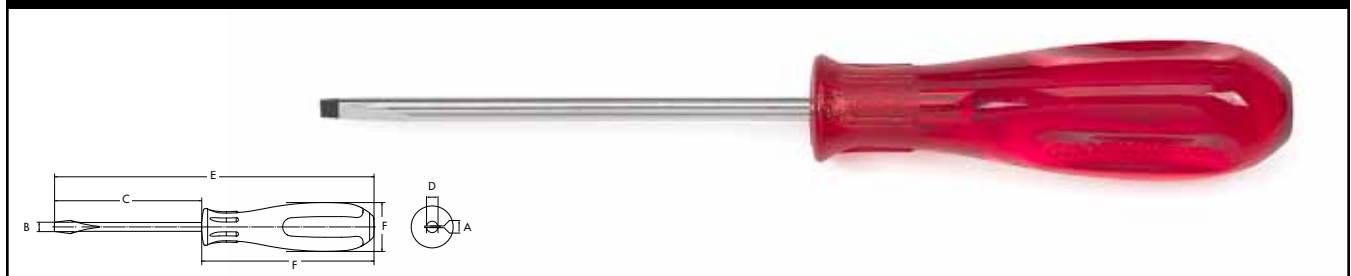

Item No.	Size	Tip Thickness (inch) A	Tip Width (inch) B	Blade Length (inch) C	Blade Dia. (inch) D	Overall Length (inch) E	Handle Size (D x L)(inch) F	Weight (lbs)
82701	1/8" x 4	0.022	0.125	4.070	0.118	6.800	0.860 x 2.760	0.055
82711	3/16" x 4	0.033	0.197	4.070	0.197	8.050	1.220 x 3.940	0.159
82712	3/16" x 8	0.033	0.187	8.050	0.197	11.900	1.220 x 3.940	0.195

Open Stock - Solid Handle Screwdrivers PHILLIPS

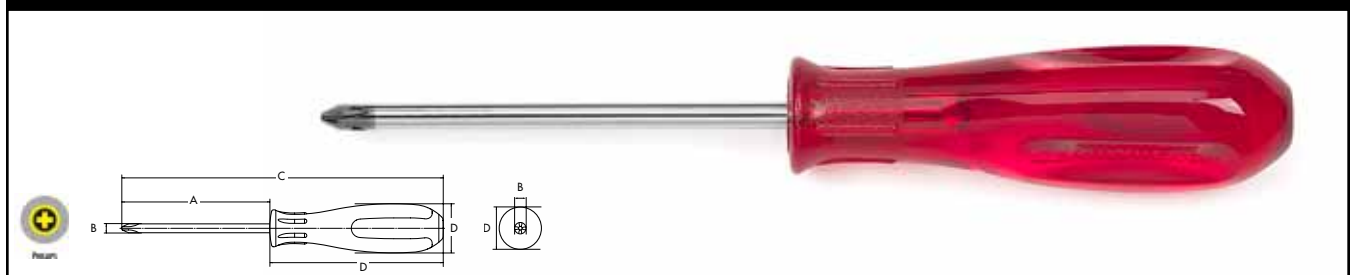

Item No.	Size	Blade Length (inch) A	Blade Dia. (inch) B	Overall Length (inch) C	Handle Size (D x L)(inch) D	Weight (lbs)
82713	#0 x 2-1/2"	2.507	0.118	5.320	0.860 x 2.76	0.053
82714	#1 x 1-1/2"	1.521	0.236	4.120	1.290 x 2.56	0.125
82715	#1 x 3"	2.972	0.197	7.00	1.220 x 3.94	0.151
82716	#2 x 1-1/2"	1.521	0.236	4.120	1.290 x 2.56	0.125
82717	#2 x 4"	4.082	0.236	8.400	1.340 x 4.33	0.221
82718	#2 x 6"	6.071	0.236	10.40	1.340 x 4.33	0.246
82719	#2 x 8"	7.877	0.236	12.400	1.340 x 4.33	0.270
82720	#3 x 6"	6.071	0.315	10.800	1.470 x 4.72	0.362
82721	#4 x 8"	7.877	0.315	12.800	1.470 x 4.72	0.505



82770 - 6 Pc. Cushion Grip Screwdriver Set

Item No.	Description
82772	#1 x 3 Cushion Grip Screwdriver
82773	#2 x 4 Cushion Grip Screwdriver
82774	#3 x 6 Cushion Grip Screwdriver
82775	3/16" x 3 Cushion Grip Screwdriver
82776	1/4" x 4 Cushion Grip Screwdriver
82777	5/16" x 6 Cushion Grip Screwdriver



82782 - 6 in 1 Screwdriver

Description
Nutdriver Shank
Double end Slotted 1/4" x Phillips #2
Double end Slotted 3/16" x Phillips #1



82765 - 7 Pc. Full Hollow Shaft Cushion Grip Nut Driver Set SAE

Item No.	Description	
82750	3/16" Nut Driver, Hollow Shaft	Black
82751	1/4" Nut Driver, Hollow Shaft	Red
82752	5/16" Nut Driver, Hollow Shaft	Yellow
82753	11/32" Nut Driver, Hollow Shaft	Green
82754	3/8" Nut Driver, Hollow Shaft	Blue
82755	7/16" Nut Driver, Hollow Shaft	Brown
82756	1/2" Nut Driver, Hollow Shaft	Red

82764 - 7 Pc. Full Hollow Shaft Cushion Grip Nut Driver Set METRIC

Item No.	Description
82757	5 mm Nut Driver, Hollow Shaft
82758	6 mm Nut Driver, Hollow Shaft
82759	7mm Nut Driver, Hollow Shaft
82760	8 mm Nut Driver, Hollow Shaft
82761	9 mm Nut Driver, Hollow Shaft
82762	10 mm Nut Driver, Hollow Shaft
82763	11 mm Nut Driver, Hollow Shaft



Open Stock - Cushion Grip Screwdrivers SLOTTED



Item No.	Size	Tip Thickness (inch) A	Tip Width (inch) B	Blade Length (inch) A	Blade Dia. (inch) B	Overall Length (inch) C	Handle Size (D x L)(inch) D	Weight (lbs)
82775	3/16" x 3"	0.033	0.187	2.972	0.197	6.740	1.240 x 3.740	0.146
82776	1/4" x 4"	0.040	0.250	6.071	0.236	8.330	1.420 x 4.330	0.230
82777	5/16" x 6"	0.050	0.312	6.071	0.315	11.000	1.500 x 5.000	0.359

Open Stock - Cushion Grip Screwdrivers PHILLIPS



Item No.	Size	Blade Length (inch) A	Blade Dia. (inch) B	Overall Length (inch) C	Handle Size (D x L)(inch) D	Weight (lbs)
82772	#1 x 3"	2.972	0.197	6.740	1.240 x 3.740	0.146
82773	#2 x 4"	4.070	0.236	8.330	1.420 x 4.330	0.232
82774	#3 x 6"	6.071	0.315	11.000	1.500 x 5.000	0.359

OPEN STOCK
SCREWDRIVERS

Open Stock - Cushion Grip Nut Drivers SAE



Item No.	Size	Drive End (inch) A	Shaft Length (inch) B	Bolt Clearance (inch) C	Overall Length (inch) D	Handle Size (D x L)(inch) E	Weight (lbs)
82750	3/16"	0.385	3.000	0.185	7.330	1.420 x 4.330	0.218
82751	1/4"	0.450	3.000	0.250	7.330	1.420 x 4.330	0.232
82752	5/16"	0.510	3.000	0.312	7.330	1.420 x 4.330	0.262
82753	11/32"	0.545	3.000	0.343	7.330	1.420 x 4.330	0.270
82754	3/8"	0.585	3.000	0.375	7.330	1.420 x 4.330	0.280
82755	7/16"	0.660	3.000	0.437	7.330	1.420 x 4.330	0.294
82756	1/2"	0.720	3.000	0.500	8.000	1.500 x 5.000	0.392

Open Stock - Cushion Grip Nut Drivers METRIC



Item No.	Size	Drive End (inch) A	Shaft Length (inch) B	Bolt Clearance (inch) C	Overall Length (inch) D	Handle Size (D x L)(inch) E	Weight (lbs)
82757	6 mm	0.425	3.000	0.236	7.330	1.420 x 4.330	0.254
82758	7 mm	0.476	3.000	0.275	7.330	1.420 x 4.330	0.260
82759	8 mm	0.511	3.000	0.314	7.330	1.420 x 4.330	0.275
82760	9 mm	0.543	3.000	0.354	7.330	1.420 x 4.330	0.281
82761	10 mm	0.614	3.000	0.393	7.330	1.420 x 4.330	0.287
82762	11 mm	0.661	3.000	0.433	7.330	1.420 x 4.330	0.294
82763	12 mm	0.689	3.000	0.472	8.000	1.500 x 5000	0.392

SCREWDRIVERS OPEN STOCK

80063 - 7 Pc. Insulated Screwdriver Set

Item No.	Description
80047	3/32" (2.5mm) x 3" Insulated Slotted Screwdriver
80048	5/32" (4.0mm) x 4" Insulated Slotted Screwdriver
80049	7/32" (5.5mm) x 5" Insulated Slotted Screwdriver
80080	1/4" (6.5mm) x 6" Insulated Slotted Screwdriver
80081	#1 x 3-1/8" Insulated Phillips Screwdriver
80082	#2 x 4" Insulated Phillips Screwdriver
80083	#0 x 2-1/2" Insulated Phillips Screwdriver

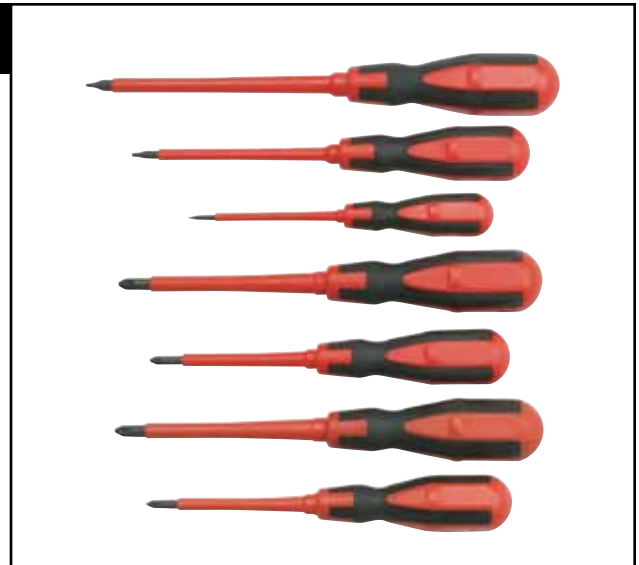

82901 - 8 Pc. SAE Insulated Nut Driver Set

Item No.	Description
82902	3/16" Nut Driver Insulated
82903	1/4" Nut Driver Insulated
82904	5/16" Nut Driver Insulated
82905	11/32" Nut Driver Insulated
82906	3/8" Nut Driver Insulated
82907	7/16" Nut Driver Insulated
82908	1/2" Nut Driver Insulated
82909	9/16" Nut Driver Insulated



82900 - 8 Pc. METRIC Insulated Nut Driver Set

Item No.	Description
82910	6 mm Nut Driver Insulated
82911	7 mm Nut Driver Insulated
82912	8 mm Nut Driver Insulated
82913	9 mm Nut Driver Insulated
82914	10 mm Nut Driver Insulated
82915	11 mm Nut Driver Insulated
82916	12 mm Nut Driver Insulated
82917	13 mm Nut Driver Insulated



Open Stock - Insulated Screwdrivers *SLOTTED*



Item No.	Size	Tip Thickness (inch) A	Tip Width (inch) B	Blade Length (inch) C	Blade Dia. (inch) D	Overall Length (inch) E	Handle Size (D x L)(inch) F	Weight (lbs)
80047	3/32" (2.5 mm) x 3"	0.016	0.094	2.956	0.169	5.783	.875 x 2.823	0.070
80048	5/32" (4.0 mm) x 4"	0.027	0.156	3.932	0.229	7.541	1.126 x 3.591	0.190
80049	7/32" (5.5 mm) x 5"	0.035	0.219	4.919	0.288	8.950	1.273 x 4.000	0.170
80080	1/4" (6.5 mm) x 6"	0.040	0.250	5.900	0.330	9.925	1.27 x 4.050	0.180

Open Stock - Insulated Screwdrivers *PHILLIPS*



Item No.	Size	Blade Length (inch) A	Blade Dia. (inch) B	Overall Length (inch) C	Handle Size (D x L)(inch) D	Weight (lbs)
80081	#1 x 3-1/8"	3.142	0.255	6.752	1.128 x 3.608	0.160
80082	#2 x 4"	3.940	0.308	7.950	1.278 x 4.03	0.170
80083	#0 x 2-1/2"	2.362	0.189	5.194	.885 x 2.83	0.140

Open Stock - Insulated Screwdrivers *POZIDRIV®*



Item No.	Size	Blade Length (inch) A	Blade Dia. (inch) B	Overall Length (inch) C	Handle Size (D x L)(inch) D	Weight (lbs)
80084	#1 x 3-1/8"	3.152	0.254	6.755	1.145 x 3.6	0.150
80085	#2 x 4"	3.940	0.307	7.541	1.282 x 4.028	0.170

OPEN STOCK
SCREWDRIVERS

Open Stock - Insulated Nut Drivers SAE



Item No.	Size	Drive End (inch) A	Shaft Length (inch) B	Bolt Clearance (inch) C	Overall Length (inch) D	Handle Size (D x L)(inch) E	Weight (lbs)
82902	3/16"	0.54	5.000	0.187	9.45	1.42 x 4.45	0.250
82903	1/4"	0.6	5.000	0.250	9.45	1.42 x 4.45	0.270
82904	5/16"	0.66	5.000	0.312	9.45	1.42 x 4.45	0.272
82905	11/32"	0.7	5.000	0.343	9.45	1.42 x 4.45	0.276
82906	3/8"	0.74	5.000	0.375	9.45	1.42 x 4.45	0.284
82907	7/16"	0.81	5.000	0.437	9.45	1.42 x 4.45	0.334
82908	1/2"	0.81	5.000	0.500	9.45	1.42 x 4.45	0.340
82909	9/16"	0.87	5.000	0.562	9.45	1.42 x 4.45	0.360

Open Stock - Insulated Nut Drivers METRIC



Item No.	Size	Drive End (inch) A	Shaft Length (inch) B	Bolt Clearance (inch) C	Overall Length (inch) D	Handle Size (D x L)(inch) E	Weight (lbs)
82910	6 mm	0.531	5.000	0.236	9.45	1.42 x 4.45	0.270
82911	7 mm	0.626	5.000	0.275	9.45	1.42 x 4.45	0.272
82912	8 mm	0.661	5.000	0.314	9.45	1.42 x 4.45	0.275
82913	9 mm	0.692	5.000	0.354	9.45	1.42 x 4.45	0.276
82914	10 mm	0.763	5.000	0.393	9.45	1.42 x 4.45	0.284
82915	11 mm	0.811	5.000	0.433	9.45	1.42 x 4.45	0.334
82916	12 mm	0.838	5.000	0.472	9.45	1.42 x 4.45	0.340
82917	13 mm	0.878	5.000	0.511	9.45	1.42 x 4.45	0.360



Magnetic Bit Holding Screwdriver

Item No.	Description
82783	1/4" Magnetic Bit Holding Screwdriver



80072 - 2 Pc. Offset Screwdriver Set

Item No.	Description
	1/4" Slotted x #2 Phillips Offset Screwdriver
	3/16" Slotted x #1 Phillips Offset Screwdriver

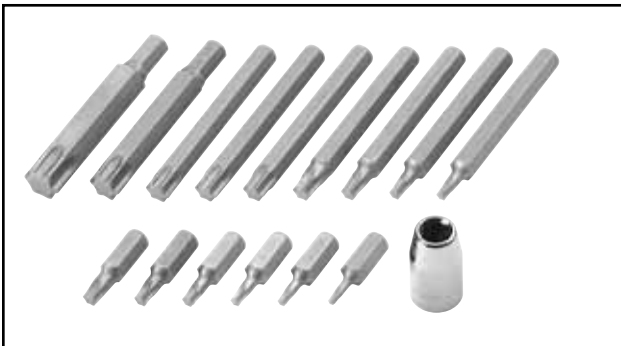

80585 - 16 Pc. Industrial TORX® Driver Set

Item No.	Description
	3/8" M x 5/16" F Bit Holder
T-10	5/16" x 30 mm Torx Insert Bit
T-15	5/16" x 30 mm Torx Insert Bit
T-20	5/16" x 30 mm Torx Insert Bit
T-25	5/16" x 30 mm Torx Insert Bit
T-27	5/16" x 30 mm Torx Insert Bit
T-30	5/16" x 30 mm Torx Insert Bit
T-20	5/16" x 70 mm Torx Insert Bit
T-25	5/16" x 70 mm Torx Insert Bit
T-30	5/16" x 70 mm Torx Insert Bit
T-40	5/16" x 70 mm Torx Insert Bit

T-45	5/16" x 70 mm Torx Insert Bit
T-47	5/16" x 70 mm Torx Insert Bit
T-50	5/16" x 70 mm Torx Insert Bit
T-55	5/16" x 70 mm Torx Insert Bit
T-60	5/16" x 70 mm Torx Insert Bit

Open Stock - Screw Holding Drivers



Item No.	Size	Blade Length (inch)	Blade Dia. (inch)	Overall Length (inch)	Handle Size (D x L) (inch)	Weight (lbs)
82791	3/16" x 6 Slotted	6"	0.197	9.74	1.24 x 3.74	0.212
82792	#1 x 3 Phillips	3"	0.197	6.74	1.24 x 3.74	0.173
82793	#2 x 7 Phillips	7"	0.236	11.33	1.42 x 4.33	0.300

82784 - 83 Pc. Screwdriver Accessory Set

Description	Qty.
1/4" Bit Holder	1
Pozidriv® #2 Bit	1
Pozidriv® #3 Bit	2
Slotted 6 - 8 Bit	3
Slotted 8 - 10 Bit	3
Slotted 10 - 12 Bit	3
Slotted 12 - 14 Bit	2
Square #2 Bit	3
Square #3 Bit	3
T-10 Torx® Bit	2
T-15 Torx® Bit	2
T-20 Torx® Bit	2
T-25 Torx® Bit	2
T-27 Torx® Bit	2
T-30 Torx® Bit	2
T-40 Torx® Bit	2
Hex 5/32" Bit	3
Hex 3/16" Bit	2
Hex 7/32" Bit	2
Hex 1/4" Bit	2
Hex 5/16" Bit	2
Phillips #3 Bit	3
Phillips #2 Bit	3
Phillips #1 Bit	1
Phillips #0 Bit	1
Tamper-proof T-30 Torx® Bit	1
Tamper-proof T-27 Torx® Bit	1
Tamper-proof T-25 Torx® Bit	1
Tamper-proof T-20 Torx® Bit	1
Tamper-proof T-15 Torx® Bit	1
Tamper-proof T-10 Torx® Bit	1
Tamper-proof T-8 Torx® Bit	1
Tamper-proof T-7 Torx® Bit	1



Description	Qty.
Phillips #1 Bit	1
Phillips #2 Bit	2
Phillips #3 Bit	1
Pozidriv® #3 Bit	1
Pozidriv® #2 Bit	1
Slotted 8 - 10 Bit	2
Slotted 10 - 12 Bit	1
Slotted 12 - 14 Bit	1
T-15 Torx® Bit	1
T-20 Torx® Bit	1
T-25 Torx® Bit	1
1/4" Nut Setter SW 5/32"	1
1/4" Nut Setter SW 3/16"	1
1/4" Nut Setter SW 1/4"	1
1/4" Nut Setter SW 9/32"	1
1/4" Nut Setter SW 5/16"	1
1/4" Nut Setter SW 11/32"	1
1/4" Nut Setter SW 3/8"	1
1/4" Nut Setter SW 7/16"	1

**8940 - 40 Pc. Ratcheting Screwdriver Set**

Item No.	Description	
890001GD	Ratcheting Screwdriver Handle - Red	
890005GD	Ratcheting Screwdriver Stubby Handle - Red	
890006GD	Ratcheting Screwdriver T-Handle - Red	
310901GR	3-1/2"	1/4" Shank Magnetic Bit Shaft
310902GR	6"	1/4" Shank Magnetic Bit Shaft
311901GR	3-1/2"	1/4" Shank Socket Shaft
311902GR	6" 1/4"	1/4" Shank Socket Shaft
890008GD	11" 1/4"	1/4" 180° Flex Bit Shaft
890009GD	11" 1/4"	1/4" 180° Flex Socket Shaft
890007GD	Adapter for Connecting Two 1/4" Shafts	
890003GD	30 Pc. Bit Set in Case	
	3 mm	Hex Bit
	4 mm	Hex Bit
	5 mm	Hex Bit
	6 mm	Hex Bit
	7 mm	Hex Bit
	8 mm	Hex Bit
	1/8"	Hex Bit
	5/32"	Hex Bit
	3/16"	Hex Bit
	7/32"	Hex Bit
	1/4"	Hex Bit
	5/16"	Hex Bit
	#0	Phillips Bit
	#1	Phillips Bit
	#2	Phillips Bit
	#3	Phillips Bit
	4mm	Slotted Bit
	5.5mm	Slotted Bit
	6.5mm	Slotted Bit
	5/32"	Slotted Bit
	7/32"	Slotted Bit
	1/4"	Slotted Bit
	T-8	Torx® Bit
	T-10	Torx® Bit
	T-15	Torx® Bit
	T-20	Torx® Bit
	T-25	Torx® Bit
	T-27	Torx® Bit
	T-30	Torx® Bit
	T-40	Torx® Bit

8939 - 39 Pc. Ratcheting Screwdriver Set

Item No.	Description	
890001GD	Ratcheting Screwdriver Handle - Red	
310901GR	3-1/2"	1/4" Shank Magnetic Bit Shaft
310902GR	6"	1/4" Shank Magnetic Bit Shaft
310903GR	10"	1/4" Shank Magnetic Bit Shaft
311901GR	3-1/2"	1/4" Shank Socket Shaft
311902GR	6"	1/4" Shank Socket Shaft
311904GR	10"	1/4" Shank Socket Shaft
311903GR	6"	1/4" Flexible Socket Shaft
890002GD	1/4" Hex Shank Bit Adapter	
890003GD	30 Pc. Bit Set in Case	
	3 mm	Hex Bit
	4 mm	Hex Bit
	5 mm	Hex Bit
	6 mm	Hex Bit
	7 mm	Hex Bit
	8 mm	Hex Bit
	1/8"	Hex Bit
	5/32"	Hex Bit
	3/16"	Hex Bit
	7/32"	Hex Bit
	1/4"	Hex Bit
	5/16"	Hex Bit
	#0	Phillips Bit
	#1	Phillips Bit
	#2	Phillips Bit
	#3	Phillips Bit
	4mm	Slotted Bit
	5.5mm	Slotted Bit
	6.5mm	Slotted Bit
	5/32"	Slotted Bit
	7/32"	Slotted Bit
	1/4"	Slotted Bit
	T-8	Torx® Bit
	T-10	Torx® Bit
	T-15	Torx® Bit
	T-20	Torx® Bit
	T-25	Torx® Bit
	T-27	Torx® Bit
	T-30	Torx® Bit
	T-40	Torx® Bit





8926 - 26 Pc. Ratcheting Screwdriver Set

Item No.	Description
890001GD	Ratcheting Screwdriver Handle - Red
311901GR	3-1/2" 1/4" Shank Socket Shaft
311902GR	6" 1/4" Shank Socket Shaft
311904GR	10" 1/4" Shank Socket Shaft
311903GR	6" 1/4" Shank Flexible Socket Shaft
890002GD	1/4" Hex Shank Bit Adapter
NS-8926A	20 Pc. Bit Set in Holder
	3/32" Hex Bit
	1/8" Hex Bit
	5/32" Hex Bit
	3/16" Hex Bit
	1/4" Hex Bit
	5/16" Hex Bit
	#1 Phillips Bit
	#2 Phillips Bit
	#2 Phillips Bit
	#3 Phillips Bit
	5/32" Slotted Bit
	3/16" Slotted Bit
	1/4" Slotted Bit
	1/4" Slotted Bit
	T-10 Torx® Bit
	T-15 Torx® Bit
	T-20 Torx® Bit
	T-25 Torx® Bit
	T-30 Torx® Bit
	T-40 Torx® Bit

82780 - 32 Pc. Ratcheting GearDriver™ Set

Item No.	Description
890001GD	Ratcheting Screwdriver Handle - Red
	50 mm Socket Adapter
	6" Extension Bar
	1/8" Hex Bit
	5/32" Hex Bit
	3/16" Hex Bit
	7/32" Hex Bit
	1/4" Hex Bit
	5/16" Hex Bit
	3 mm Hex Bit
	4 mm Hex Bit
	5 mm Hex Bit
	6 mm Hex Bit
	7 mm Hex Bit
	8 mm Hex Bit
	5/32" Slotted Bit
	7/32" Slotted Bit
	1/4" Slotted Bit
	4 mm Slotted Bit
	5.5 mm Slotted Bit
	6.5 mm Slotted Bit



T-8	Torx® Bit
T-10	Torx® Bit
T-15	Torx® Bit
T-20	Torx® Bit
T-25	Torx® Bit
T-27	Torx® Bit
T-30	Torx® Bit
T-40	Torx® Bit
#0	Phillips Bit
#1	Phillips Bit
#2	Phillips Bit
#3	Phillips Bit

8915 - 15 Pc. Stubby Ratcheting Screwdriver Set

Item No.	Description
890005GD	Ratcheting Screwdriver Stubby Handle - Red
310901GR	3-1/2" 1/4" Shank Magnetic Bit Shaft
310902GR	6" 1/4" Shank Magnetic Bit Shaft
310903GR	10" 1/4" Shank Magnetic Bit Shaft
890008GD	11" 1/4" Shank 180° Flex Bit Shaft
890010GD	10 Pc. Bit Set in Holder
	#1 Phillips Bit
	#2 Phillips Bit
	#3 Phillips Bit
	4 mm Slotted Bit
	5.5 mm Slotted Bit
	6.5 mm Slotted Bit



T-10	Torx® Bit
T-15	Torx® Bit
T-20	Torx® Bit
T-25	Torx® Bit



82781 - 7 Pc. Ratcheting GearDriver™ Set

Item No.	Description
89001GD	Ratcheting Screwdriver Handle - Red
	1/8" Hex Bit
	5/32" Hex Bit
	5/32" Hex Bit
	#0 Phillips Bit
	#1 Phillips Bit
	#2 Phillips Bit



8906 - 6 Pc. Ratcheting T-Handle Screwdriver Set

Item No.	Description
890006GD	Ratcheting Screwdriver T-Handle - Red
311901GR	3-1/2" 1/4" Shank Socket Shaft
311902GR	10" 1/4" Shank Socket Shaft
311904GR	10" 1/4" Shank Socket Shaft
890009GD	11" 1/4" Shank 180° Flex Socket Shaft
890007GD	Adapter for Connecting Two 1/4" Shafts



**8916 - 16 Pc. Ratcheting Nut Driver Set
SAE/ METRIC**

Item No.	Description
890005GD	Ratcheting Screwdriver Stubby Handle - Red
890060GD	3/16" Nut Driver Shaft
890080GD	1/4" Nut Driver Shaft
890100GD	5/16" Nut Driver Shaft
890110GD	11/32" Nut Driver Shaft
890120GD	3/8" Nut Driver Shaft
890140GD	7/16" Nut Driver Shaft
890160GD	1/2" Nut Driver Shaft
891050GD	5mm Nut Driver Shaft
891060GD	6mm Nut Driver Shaft
891070GD	7mm Nut Driver Shaft
891080GD	8mm Nut Driver Shaft
891090GD	9mm Nut Driver Shaft
891100GD	10mm Nut Driver Shaft
891110GD	11mm Nut Driver Shaft
891120GD	12mm Nut Driver Shaft

8908 - 8 Pc. Ratcheting Nut Driver Set SAE

Item No.	Description
890005GD	Ratcheting Screwdriver Stubby Handle - Red
890060GD	3/16" Nut Driver Shaft
890080GD	1/4" Nut Driver Shaft
890100GD	5/16" Nut Driver Shaft
890110GD	11/32" Nut Driver Shaft
890120GD	3/8" Nut Driver Shaft
890140GD	7/16" Nut Driver Shaft
890160GD	1/2" Nut Driver Shaft



8909 - 9 Pc. Ratcheting Nut Driver Set METRIC

Item No.	Description
890005GD	Ratcheting Screwdriver Stubby Handle - Red
891050GD	5mm Nut Driver Shaft
891060GD	6mm Nut Driver Shaft
891070GD	7mm Nut Driver Shaft
891080GD	8mm Nut Driver Shaft
891090GD	9mm Nut Driver Shaft
891100GD	10mm Nut Driver Shaft
891110GD	11mm Nut Driver Shaft
891120GD	12mm Nut Driver Shaft



Open Stock - Bit Sets and Adapters

Item No.	Description	Weight (lbs)
312901GD	Adapter for 13 mm Vortex® Socket	0.040
890002GD	1/4" Hex Shank Bit Adapter	0.030
890003GD	30 Pc. Bit Set in Box	0.539
890004GD	31 Pc. Bit Set in Box: Includes 1/4" Drive to Bit Adapter	0.030
890007GD	Adapter for Connecting Two 1/4" Shafts	0.048
890010GD	10 Pc. Bit Set with Holder	0.508

Open Stock - Ratcheting Screwdriver Handles and Shafts



Item No.	Description	Length	Weight (lbs)
890006GD	Ratcheting Screwdriver T-Handle - Red		0.364
890001GD	Ratcheting Screwdriver Handle - Red		0.300
890005GD	Ratcheting Screwdriver Stubby Handle - Red		0.293
310903GR	1/4" Shank Magnetic Bit Shaft	10"	0.239
310902GR	1/4" Shank Magnetic Bit Shaft	6"	0.142
310901GR	1/4" Shank Magnetic Bit Shaft	3.5"	0.085
311902GR	1/4" Shank Socket Shaft	6"	0.130
311903GR	1/4" Shank Flexible Socket Shaft	6"	0.136
311904GR	1/4" Shank Socket Shaft	10"	0.134
311901GR	1/4" Shank Socket Shaft	3.5"	0.076

Open Stock - Ratcheting Nut Driver Shafts



Item No.	Description	Weight (lbs)	Item No.	Description	Weight (lbs)
890008GD	11" 1/4" Shank 180® Flex Bit Shaft	0.272	891050GD	5 mm Nut Driver Shaft	0.082
890009GD	11" 1/4" Shank 180® Flex Socket Shaft	0.27	891060GD	6 mm Nut Driver Shaft	0.082
890060GD	3/16" Nut Driver Shaft	0.083	891070GD	7 mm Nut Driver Shaft	0.083
890080GD	1/4" Nut Driver Shaft	0.083	891080GD	8 mm Nut Driver Shaft	0.086
890140GD	7/16" Nut Driver Shaft	0.106	891090GD	9 mm Nut Driver Shaft	0.091
890160GD	1/2" Nut Driver Shaft	0.115	891100GD	10 mm Nut Driver Shaft	0.093
890120GD	3/8" Nut Driver Shaft	0.093	891110GD	11 mm Nut Driver Shaft	0.106
890100GD	5/16" Nut Driver Shaft	0.089	891120GD	12 mm Nut Driver Shaft	0.114
890110GD	11/32" Nut Driver Shaft	0.09			

SCREWDRIVERS OPEN STOCK

PLIERS

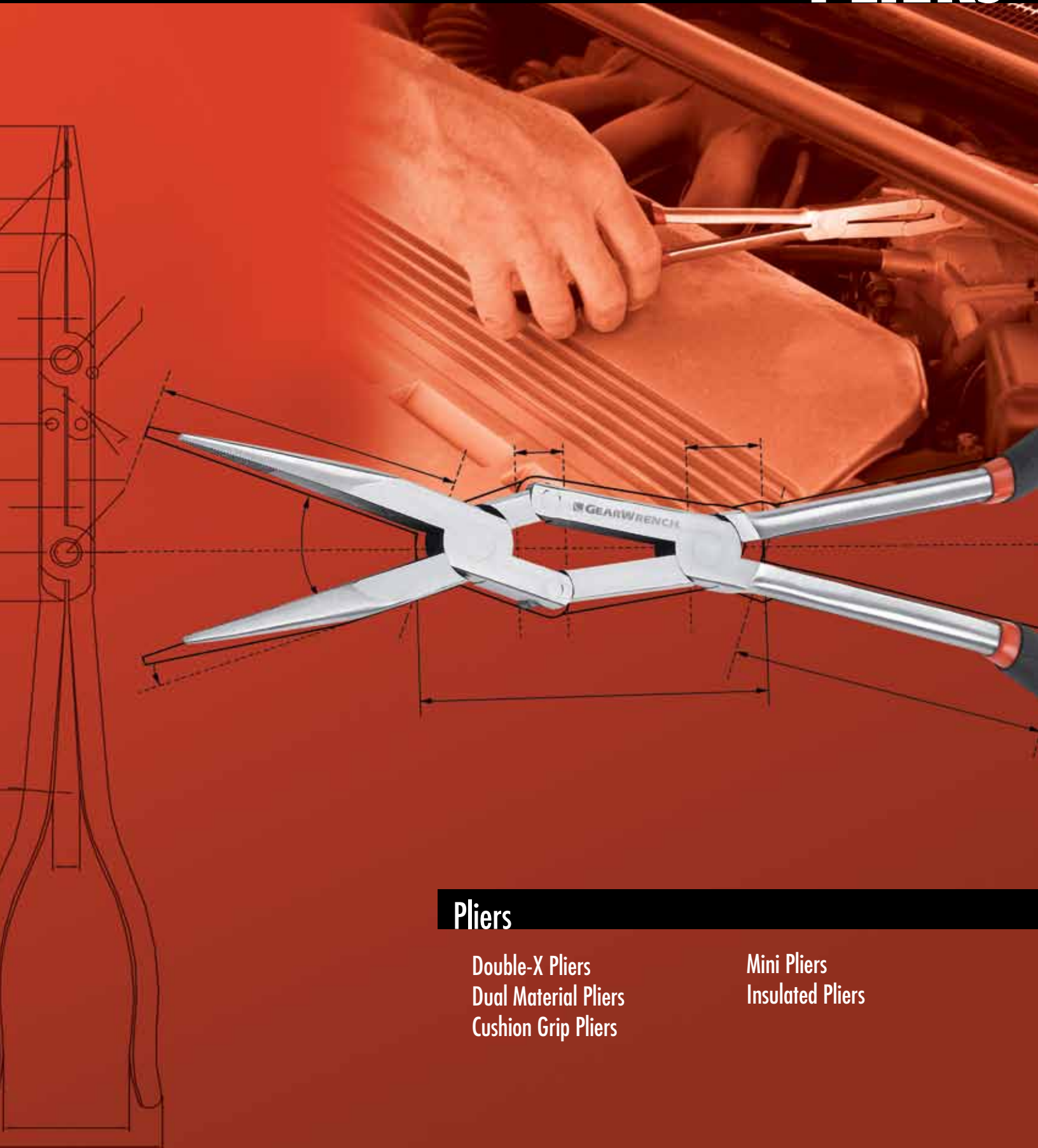

Pliers

Double-X Pliers
Dual Material Pliers
Cushion Grip Pliers

Mini Pliers
Insulated Pliers

**DOUBLE-X™
PLIERS**

PLIERS

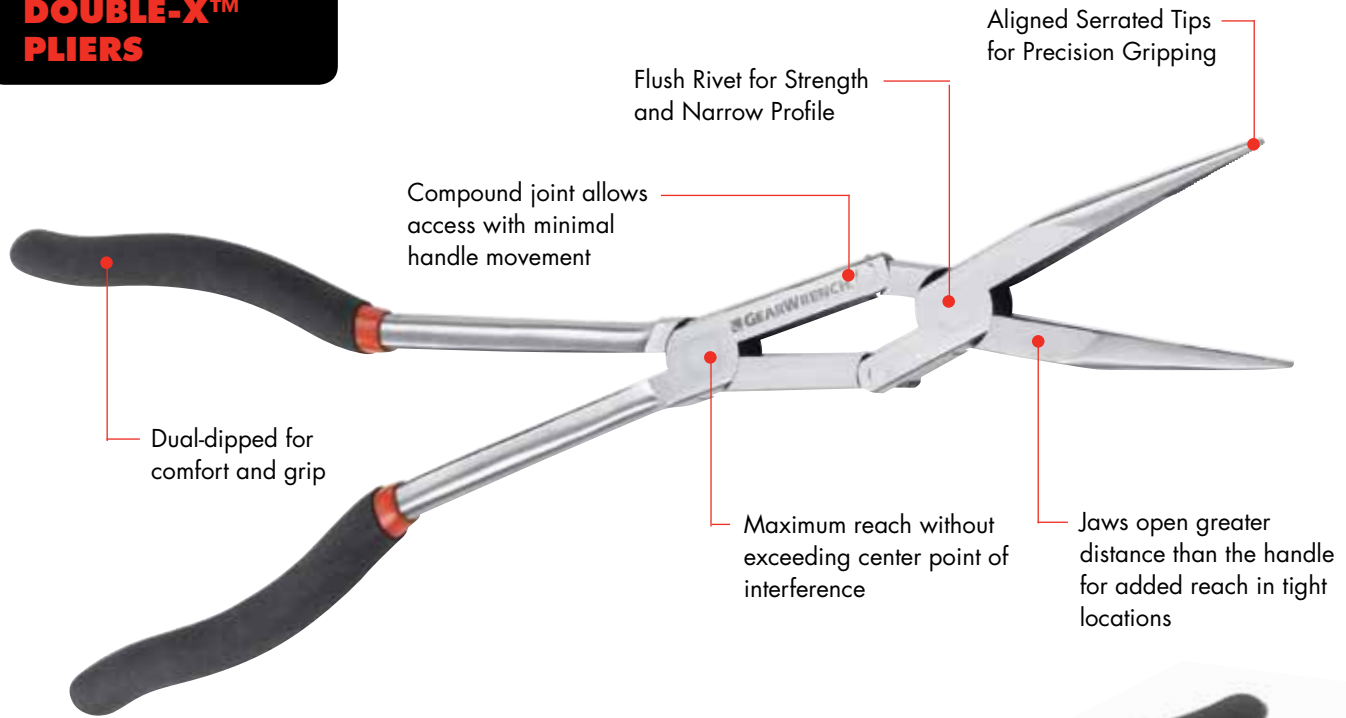

AVAILABLE IN:

- Straight Standard Pliers
- 45° Standard Pliers
- Duck Bill Standard Pliers
- Internal / External Snap Ring Pliers
- Straight Hemostat Pliers
- 45° Hemostat Pliers



APPLICATIONS

- Long reach cotter pin removal
- Use as a pick-up tool
- Tight access under engine cowlings in aviation and automotive
- Electrical terminal removal and installation

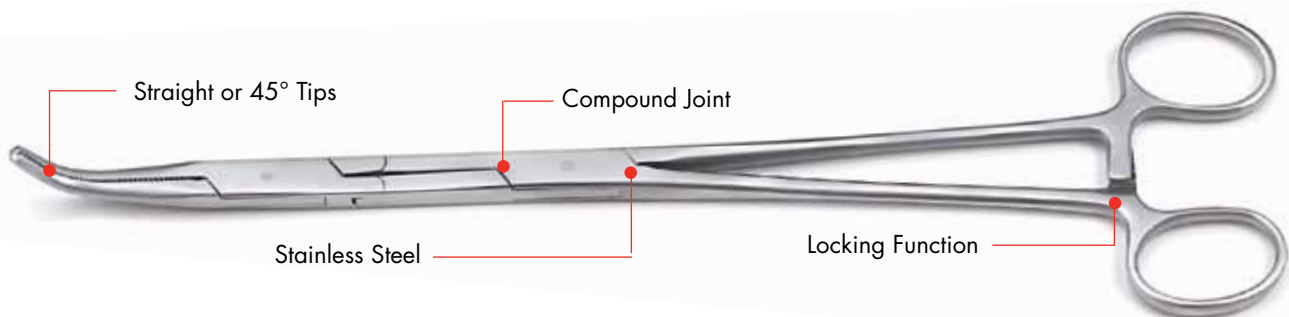

DUAL MATERIAL GRIP PLIERS

AVAILABLE IN:

- Slip Joint Pliers
- Duck Bill Pliers
- Diagonal Pliers
- Linesmans Pliers
- Bent Nose Pliers
- Groove Joint Pliers
- Long Nose Pliers
- Fence Pliers

PLIERS



CUSHION GRIP PLIERS





82108 - 7 Pc. Mixed Pliers Set

Item No.	Description
82011	Tongue and Groove Pliers
82012	Diagonal Cutting Pliers
82013	Long Nose Pliers
82014	Slip Joint Pliers
82020	12" Groove Joint Pliers with Straight Jaw
82025	8" Linesman Pliers
82028	8" End Nipper Pliers

Weight 5.5 lbs



82103 - 4 Pc. Mixed Pliers Set

Item No.	Description
82011	Tongue and Groove Pliers
82012	Diagonal Cutting Pliers
82013	Long Nose Pliers
82014	Slip Joint Pliers

Weight 3.1 lbs



82104 - 3 Pc. Mixed Pliers Set

Item No.	Description
82011	Tongue and Groove Pliers
82012	Diagonal Cutting Pliers
82013	Long Nose Pliers

Weight 2.5 lbs



80058 - 8 Pc. Mini Screwdriver & Pliers Set

Item No.	Description
82001	Long Nose Mini Pliers
82000	Diagonal Cutting Mini Pliers
80034	1.5 mm Mini Slotted Screwdriver
80035	2.0 mm Mini Slotted Screwdriver
80036	2.5 mm Mini Slotted Screwdriver
80031	#00 Mini Phillips Screwdriver
80032	#0 Mini Phillips Screwdriver
80033	#1 Mini Phillips Screwdriver

Weight 1.5 lbs

82100 - 5 Pc. Mixed Mini Pliers Set

Item No.	Description
82000	Diagonal Cutting Mini Pliers
82001	Long Nose Mini Pliers
82002	Needle Nose Mini Pliers
82003	End Cutting Nipper Mini Pliers
82004	Flat Nose Mini Pliers

Weight 0.99 lbs

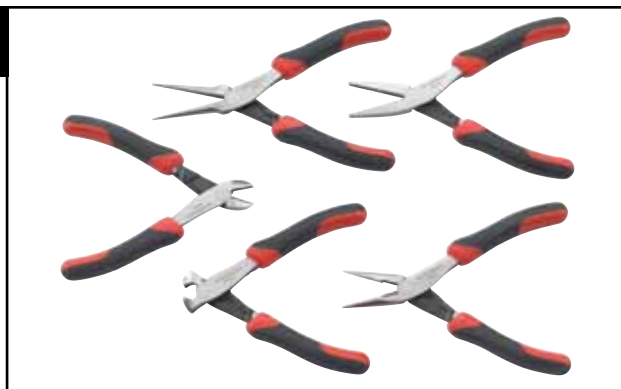

Open Stock - Slip Joint Pliers

Item No.	Size	Jaw Length A	Jaw Width B	Jaw Thickness C	Overall Length D	Weight (lbs)
82022	6"	1.73"	1.17"	0.41"	6.85"	0.16
82014	8"	1.72"	1.24"	0.14"	8.15"	0.29

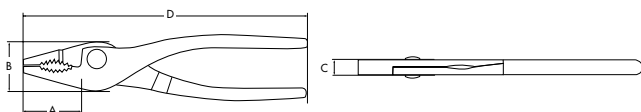

82011 - 9.5" Tongue and Groove Pliers

Jaw Length A	Jaw Width B	Jaw Thickness C	Overall Length D	Weight (lbs)
1.61"	0.73"	0.41"	9.45"	0.59

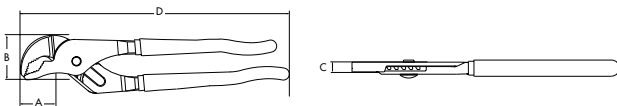

82020 - 12" Groove Joint Pliers with Straight Jaw

Jaw Length A	Jaw Width B	Jaw Thickness C	Overall Length D	Weight (lbs)
2.09"	0.65"	0.47"	11.85"	1.19

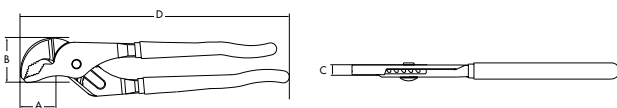



Open Stock - Diagonal Cutting Pliers

Item No.	Size	Jaw Length A	Jaw Width B	Jaw Thickness C	Overall Length D	Weight (lbs)
82008	6"	1.13"	0.75"	0.42"	6.06"	0.16
82012	7"	1.12"	1.2"	0.46"	7.01"	0.26

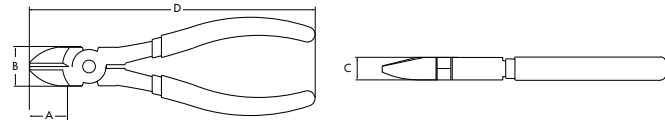

Open Stock - Long Nose Pliers

Item No.	Size	Jaw Length A	Jaw Width B	Jaw Thickness C	Overall Length D	Weight (lbs)
82010	6"	2.32"	0.69"	0.35"	6.5"	0.17
82013	8"	3.28"	0.84"	0.42"	8.23"	0.24

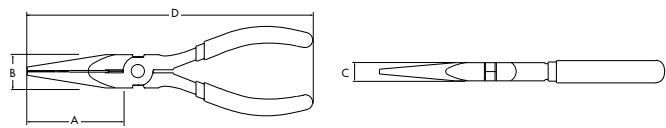

82038 - 8" Long Bent Nose Bent Pliers

Jaw Length A	Jaw Width B	Jaw Thickness C	Overall Length D	Weight (lbs)
3.28"	0.84"	0.42"	8.23"	0.24

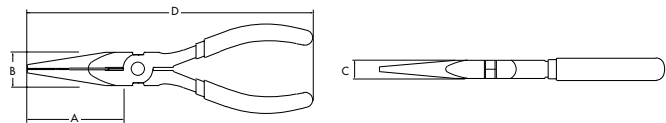

82025 - 8" Linesman Pliers

Jaw Length A	Jaw Width B	Jaw Thickness C	Overall Length D	Weight (lbs)
2.14"	1.13"	0.48"	8.03"	0.46

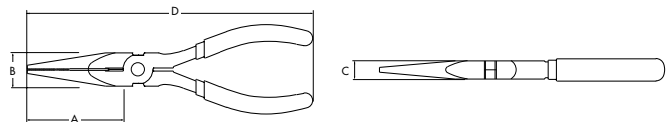

82028 - 8" End Nipper Pliers

Jaw Length A	Jaw Width B	Jaw Thickness C	Overall Length D	Weight (lbs)
0.59"	1.17"	1.02"	7.8"	0.33

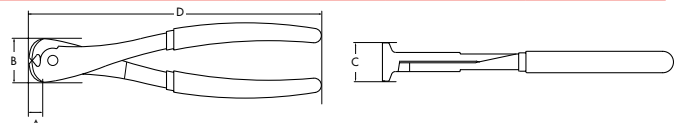

82000 - 5" Mini Diagonal Cutting Pliers

Jaw Length A	Jaw Width B	Jaw Thickness C	Overall Length D	Weight (lbs)
0.51"	0.33"	0.51"	4.45"	0.09

- Springed Handles

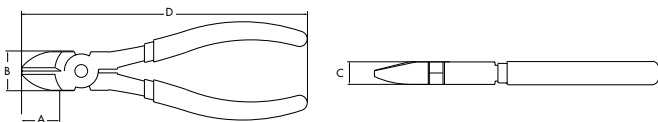

81999 - 5" Mini Bent Nose Pliers

Jaw Length A	Jaw Width B	Jaw Thickness C	Overall Length D	Weight (lbs)
1.32"	0.5"	0.33"	5.2"	0.09

- Springed Handles

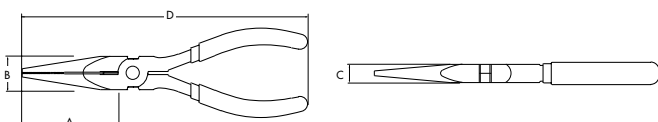

82001 - 5" Mini Long Nose Pliers

Jaw Length A	Jaw Width B	Jaw Thickness C	Overall Length D	Weight (lbs)
1.47"	0.5"	0.33"	5.2"	0.09

- Springed Handles

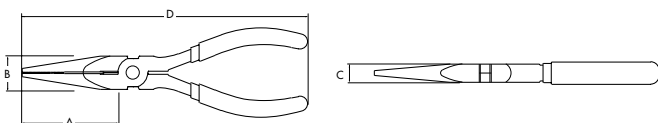

82002 - 5" Mini Needle Nose Pliers

Jaw Length A	Jaw Width B	Jaw Thickness C	Overall Length D	Weight (lbs)
1.84"	0.5"	0.33	5.59"	0.09

- Springed Handles

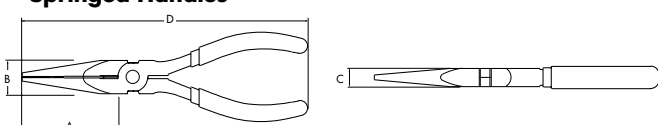



82003 - Mini End Cutting Nipper Pliers

Jaw Length A	Jaw Width B	Jaw Thickness C	Overall Length D	Weight (lbs)
0.51"	0.5"	0.51"	4.25"	0.09

- Springed Handles

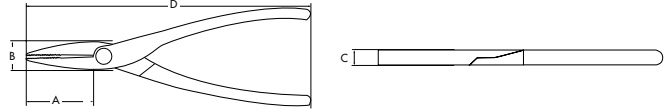

82004 - Mini Flat Nose Pliers

Jaw Length A	Jaw Width B	Jaw Thickness C	Overall Length D	Weight (lbs)
1.47"	0.5"	0.33"	5.2"	0.09

- Springed Handles

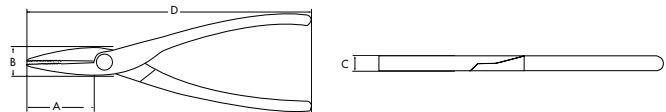

82106 - 2 Pc. Double-X™ Pliers Set

Item No.	Description
82005	Straight Double-X™ Pliers
82006	45 Degree Double-X™ Pliers

Weight 1.81 lbs



82107 - 3 Pc. Double-X™ Hose Grip Pliers Set

Item No.	Description
82017	5/16" Dia. Hose Grip Double-X™ Pliers
82018	1/2" Dia. Hose Grip Double-X™ Pliers
82019	3/4" Dia. Hose Grip Double-X™ Pliers

Weight 3.07 lbs

82110 - 2 Pc. Double-X™ Internal/External Snap Ring Pliers Set

Item No.	Description
82032	Double-X™ Internal Snap Ring Pliers
82033	Double-X™ External Snap Ring Pliers
	.038, Straight
	.038, 90°
	.047, Straight
	.047, 90°
	.070, Straight
	2 mm Hex Key
3151-77	Replacement Tip Set

Weight 1.81 lbs



82111 - 2 Pc. Double-X™ Hemostat Pliers Set

Item No.	Description
82034	Double-X™ Straight Hemostat Pliers
82035	Double-X™ 45 Degree Hemostat Pliers

Weight 0.52 lbs



82005 - Straight Double-X™ Pliers

Jaw Length A	Jaw Width B	Jaw Thickness C	Overall Length D	Weight (lbs)
3.15"	0.68"	0.39"	13.46"	0.84

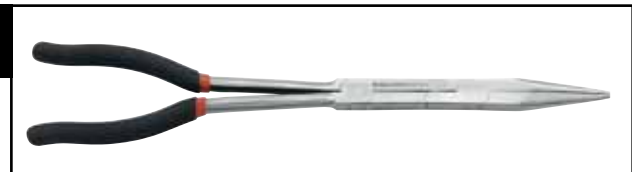
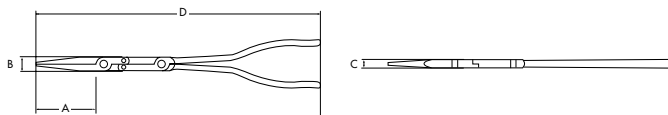

82006 - 45 Degree Double-X™ Pliers

Jaw Length A	Jaw Width B	Jaw Thickness C	Overall Length D	Weight (lbs)
2.95"	0.68"	0.39"	13.27"	0.86

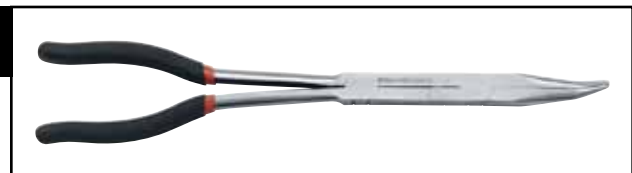
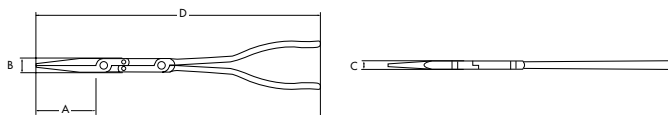

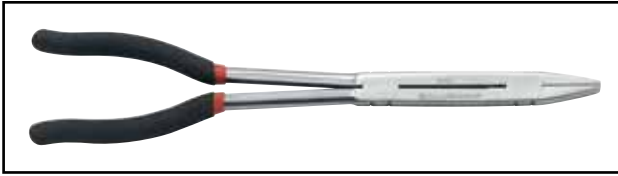

82007 - Duck Bill Double-X™ Pliers

Jaw Length A	Jaw Width B	Jaw Thickness C	Overall Length D	Weight (lbs)
1.65"	0.68"	0.39"	11.97"	0.79

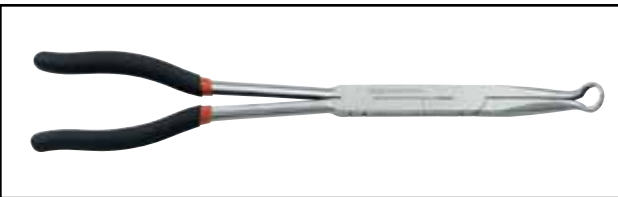
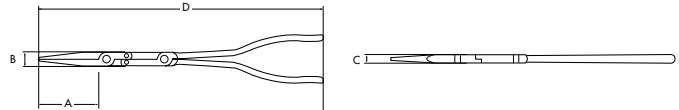

Open Stock - Hose Grip Double-X™ Pliers

Item No.	Size	Jaw Length A	Jaw Width B	Jaw Thickness C	Overall Length D	Weight (lbs)
82017	5/16"	2.87"	0.68"	0.39"	13.19"	0.83
82018	1/2"	2.81"	0.68"	0.39"	13.13"	0.83
82019	3/4"	2.72"	0.68"	0.39"	13.03"	0.83

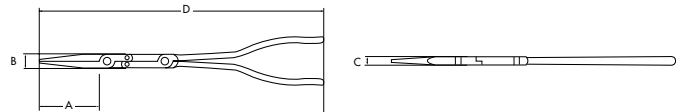

82032 - Double-X™ Internal Snap Ring Pliers

Jaw Length A	Jaw Width B	Jaw Thickness C	Overall Length D	Weight (lbs)
3.15"	0.68"	0.39"	13.46"	0.88

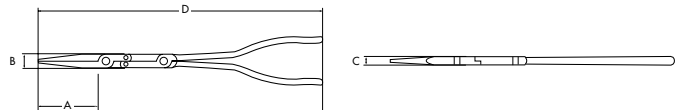

82033 - Double-X™ External Snap Ring Pliers

Jaw Length A	Jaw Width B	Jaw Thickness C	Overall Length D	Weight (lbs)
3.15"	0.68"	0.39"	13.46"	0.88

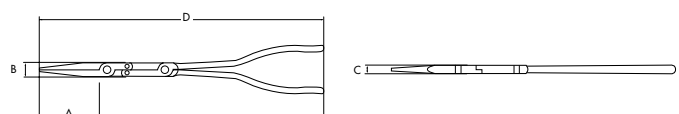

82034 - Double-X™ Straight Hemostat Pliers

Jaw Length A	Jaw Width B	Jaw Thickness C	Overall Length D	Weight (lbs)
4.22"	0.16"	0.13"	9.84"	0.21

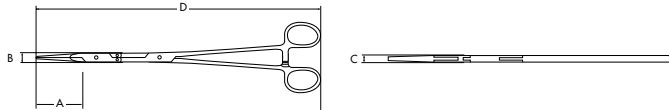

82035 - Double-X™ 45 Degree Hemostat Pliers

Jaw Length A	Jaw Width B	Jaw Thickness C	Overall Length D	Weight (lbs)
4.09"	0.16"	0.13"	9.73"	0.21

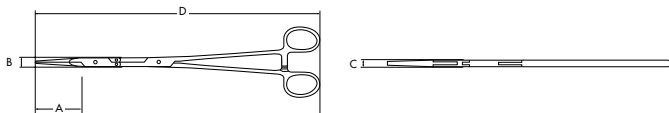

82097 - 6 Pc. Pliers Set

Item No.	Description
82079	6" Slip Joint Pliers
82081	6" Diagonal Pliers
82085	6" Long Nose Pliers
82088	8" Duck Bill Pliers
82090	9" Linesmans Pliers
82093	9-1/2" Groove Joint Pliers Diamond Jaw

Weight 5.00 lbs



82098 - 4 Pc. Pliers Set

Item No.	Description
82079	6" Slip Joint Pliers
82082	8" Wide Jaw Diagonal Pliers
82086	8" Long Nose Pliers
82093	9-1/2" Groove Joint Pliers Diamond Jaw

Weight 3.50 lbs





82099 - 3 Pc. Groove Joint Pliers Set

Item No.	Description
82093	9-1/2" Groove Joint Pliers Diamond Jaw
82094	12" Groove Joint Pliers Straight Jaw
82095	16" Groove Joint Pliers Straight Jaw

Weight 2.50 lbs



Open Stock - Slip Joint Pliers

Item No.	Size	Jaw Length A	Jaw Width B	Jaw Thickness C	Overall Length D	Weight (lbs)
82079	6"	1.73"	1.17"	0.41"	6.85"	0.16
82080	8"	1.72"	1.24"	0.41"	8.15"	0.29

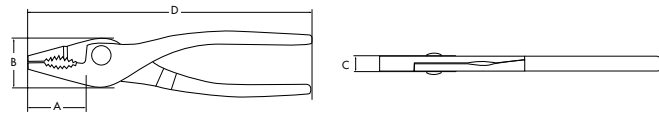

Open Stock - Groove Joint Pliers

Item No.	Description	Jaw Length A	Jaw Width B	Jaw Thickness C	Overall Length D	Weight (lbs)
82092	8" Straight Jaw	1.41"	1.81"	0.37"	7.72"	0.26
82093	9-1/2" Diamond Jaw	1.61"	0.73"	0.41"	9.45"	0.43
82094	12" Straight Jaw	2.09"	0.65"	0.47"	11.85"	0.62
82095	16" Straight Jaw	2.83"	0.95"	0.57"	16.02"	1.19

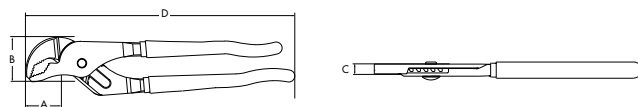

82081 - 6" Diagonal Pliers

Jaw Length A	Jaw Width B	Jaw Thickness C	Overall Length D	Weight (lbs)
1.27"	0.81"	0.47"	6.06"	0.16

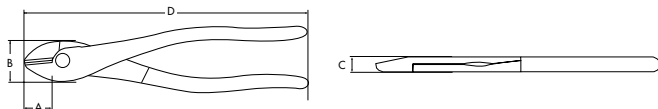

82082 - 7" Wide Jaw Diagonal Pleirs

Jaw Length A	Jaw Width B	Jaw Thickness C	Overall Length D	Weight (lbs)
1.11"	1.21"	0.46"	7.99"	0.34

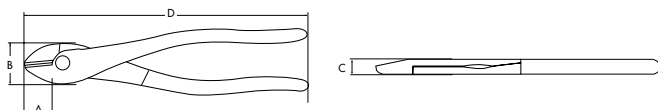

82083 - 8" Bent Nose Diagonal Pliers

Jaw Length A	Jaw Width B	Jaw Thickness C	Overall Length D	Weight (lbs)
1.11"	1.21"	0.46"	7.99"	0.34

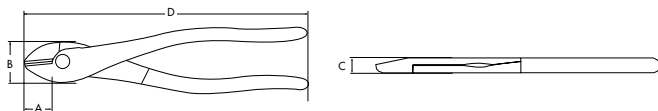

Open Stock - Long Nose Pliers

Item No.	Description	Jaw Length A	Jaw Width B	Jaw Thickness C	Overall Length D	Weight (lbs)
82085	6" Long Nose	2.61"	0.77"	0.41"	6.65"	0.17
82086	8" Long Nose	2.97"	0.89"	0.47"	7.99"	0.24

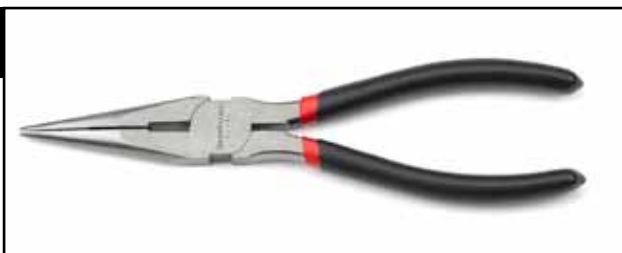
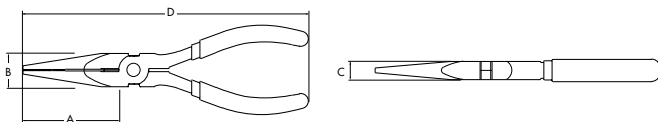



82087 - 6" Long Nose Bent Pliers

Jaw Length A	Jaw Width B	Jaw Thickness C	Overall Length D	Weight (lbs)
2.61"	0.77"	0.41"	6.65"	0.17

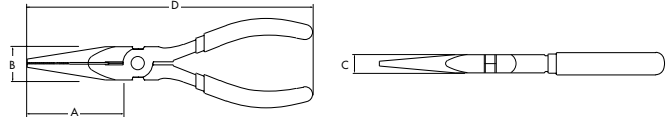

82088 - 8" Duck Bill Pliers

Jaw Length A	Jaw Width B	Jaw Thickness C	Overall Length D	Weight (lbs)
1.94"	0.51"	0.42"	7.83"	0.23

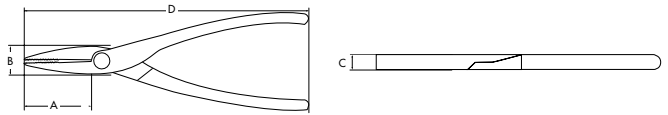

Open Stock - Linesman Pliers

Item No.	Size	Jaw Length A	Jaw Width B	Jaw Thickness C	Overall Length D	Weight (lbs)
82089	8"	1.76"	1.19"	0.61"	8.9"	0.36
82090	9"	1.88"	1.24"	0.61"	9.41"	0.40

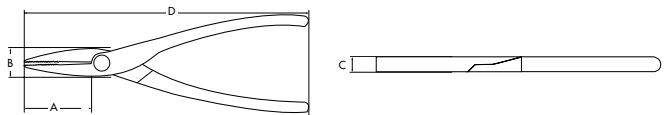

82084 - 8" End Nippers

Jaw Length A	Jaw Width B	Jaw Thickness C	Overall Length D	Weight (lbs)
0.59"	1.17"	1.02"	7.8"	0.33

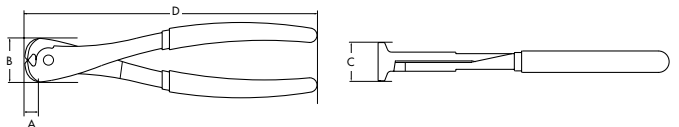

82096 - 10" Fence Pliers

Jaw Length A	Jaw Width B	Jaw Thickness C	Overall Length D	Weight (lbs)
1.55"	3.17"	0.57"	10.51"	0.68

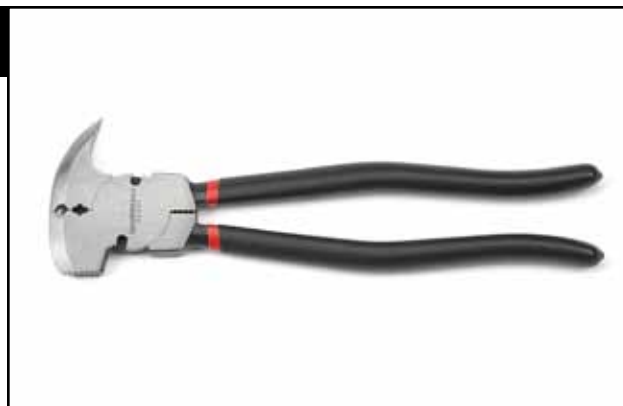

82078 - 10" Universal Cutting Pliers

Jaw Length A	Jaw Width B	Jaw Thickness C	Overall Length D	Blade Length	Weight (lbs)
1.58"	2.56"	0.67"	10.24"	3-7/8"	1.02



80062 - 10 Pc. Insulated Pliers and Screwdriver Set

Item No.	Description
80047	3/32" (2.5mm) x 3" Insulated Slotted Screwdriver
80048	5/32" (4.0mm) x 4" Insulated Slotted Screwdriver
80049	7/32" (5.5mm) x 5" Insulated Slotted Screwdriver
80081	#1 x 3-1/8" Insulated Phillips Screwdriver
80082	#2 x 4" Insulated Phillips Screwdriver
80084	#1 x 3-1/8" Insulated Pozidriv-Plus Screwdriver
80085	#2 x 4" Insulated Pozidriv-Plus Screwdriver
82029	Lineman Insulated Pliers
82030	Long Nose Insulated Pliers
82031	Diagonal Cutting Insulated Pliers



Weight 3.50



82029 - 8" Lineman Insulated Pliers

Jaw Length A	Jaw Width B	Jaw Thickness C	Overall Length D	Weight (lbs)
2.22"	1.22"	0.51"	8.31"	0.40

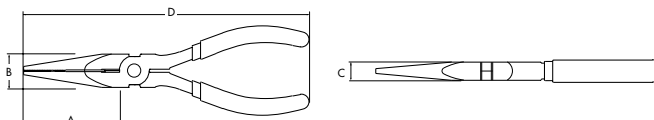

82030 - 8" Long Nose Insulated Pliers

Jaw Length A	Jaw Width B	Jaw Thickness C	Overall Length D	Weight (lbs)
3.26"	0.87"	0.43"	8.39"	0.30

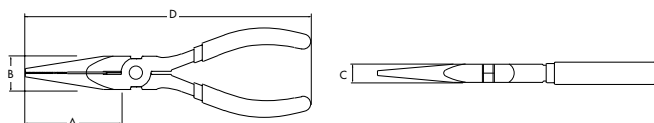

82031 - 7" Diagonal Cutting Insulated Pliers

Jaw Length A	Jaw Width B	Jaw Thickness C	Overall Length D	Weight (lbs)
1.22"	1.18"	0.47"	7.4"	0.30

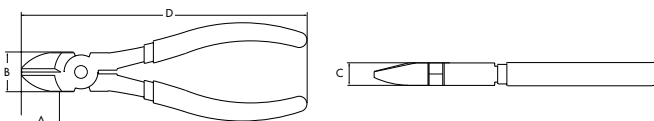

82102 - 3 Pc. Locking Pliers Set

Item No.	Description
82043	6" Long Nose Locking Pliers
82040	5" Curved Jaw Locking Pliers
82041	10" Curved Jaw Locking Pliers

Weight 4.00

82112 - 5 Pc. Locking Pliers Set

Item No.	Description
82043	6" Long Nose Locking Pliers
82040	5" Curved Jaw Locking Pliers
82041	10" Curved Jaw Locking Pliers
82045	6" C-Clamp Locking Pliers
82046	11" C-Clamp Locking Pliers

Weight 5.50



Open Stock - Jaw Locking Pliers

Item No.	Description	Jaw Length A	Jaw Width B	Jaw Thickness C	Overall Length D	Weight (lbs)
82040	5" Curved	1.57"	1.73"	0.31"	5.51"	0.38
82041	10" Curved	2.36"	2.63"	0.43"	8.79"	1.11
82042	10" Straight	2.56"	2.65"	0.55"	8.71"	1.13

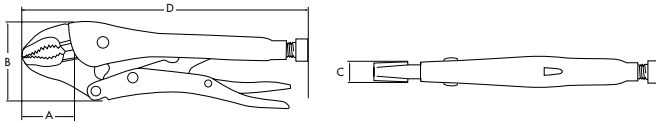

Open Stock - Long Nose Locking Pliers

Item No.	Size	Jaw Length A	Jaw Width B	Jaw Thickness C	Overall Length D	Weight (lbs)
82043	6"	2.76"	1.57"	0.12"	6.56"	0.41
82044	9"	3.7"	2.16"	0.2"	8.94"	0.84

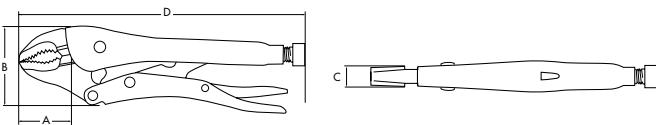



C-Clamp Locking Pliers

Item No.	Size	Jaw Length A	Jaw Width B	Jaw Thickness C	Overall Length D	Weight (lbs)
82045	6"	2.68"	3.38"	0.35"	6.79"	0.48
82046	11"	4.53"	5.62"	0.41"	11.28"	1.66
82047	18"	11.81"	6.37"	0.41"	18.57"	2.97
82048	24"	17.72"	7.1"	0.41"	24.45"	3.19

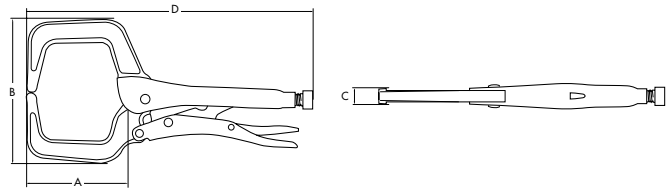

Swivel Pad C-Clamp Locking Pliers

Item No.	Size	Jaw Length A	Jaw Width B	Jaw Thickness C	Overall Length D	Weight (lbs)
82049	6"	29.53"	3.38"	0.8"	6.79"	0.49
82050	11"	4.92"	5.62"	1.11"	11.28"	1.70
82051	18"	12.32"	6.36"	1.11"	18.13"	3.30
82052	24"	18.23"	7.12"	1.11"	24.03"	3.19

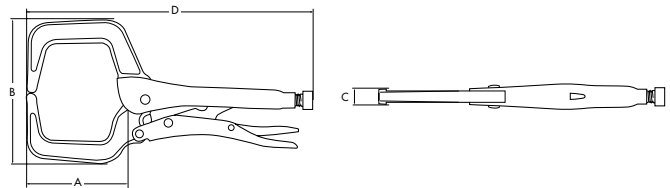

82053 - 20" Chain Clamp Locking Pliers

Jaw Length A	Jaw Width B	Jaw Thickness C	Overall Length D	Weight (lbs)
2.87"	2.49"	0.23"	8.5"	1.58

PRY BARS



Pry Bars

Indexing Pry Bar
Extendable Pry Bar
Pry Bar Sets
Indexing Nail Puller

INDEXING PRY BARS

PRY BARS

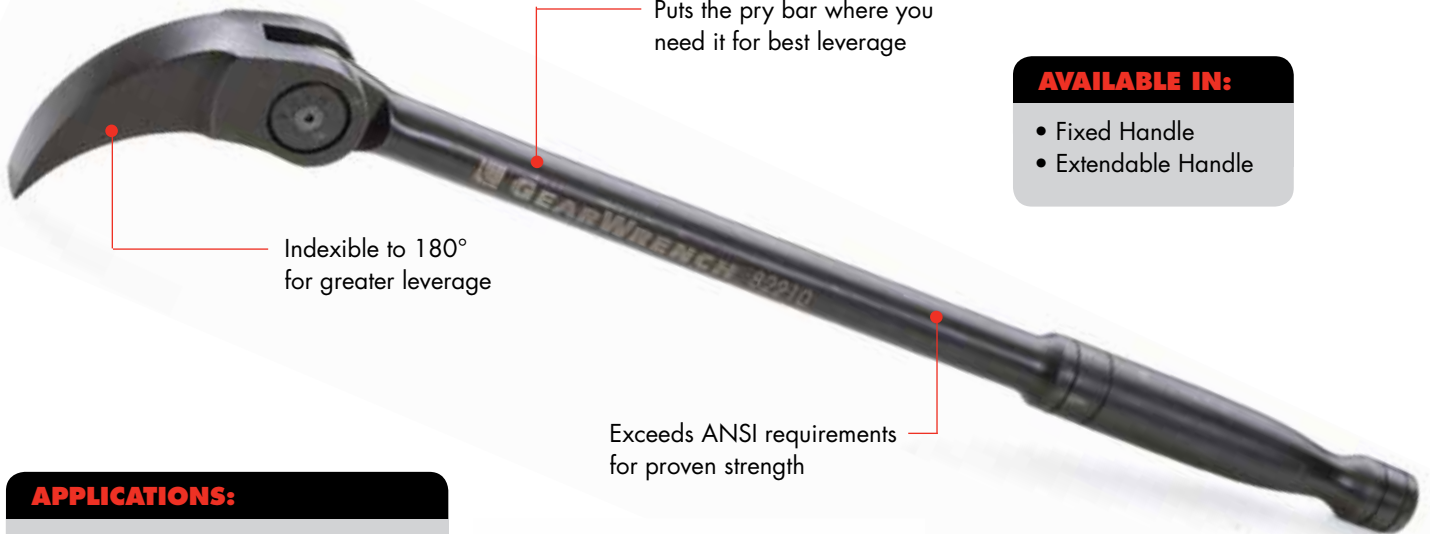

- AVAILABLE IN:**
- Fixed Handle
 - Extendable Handle

- APPLICATIONS:**
- Demolition of roof rafters and floor joists
 - Removing broken concrete
 - Repositioning equipment
 - Aligning steel components and fabrications
 - Engine repositioning and placement

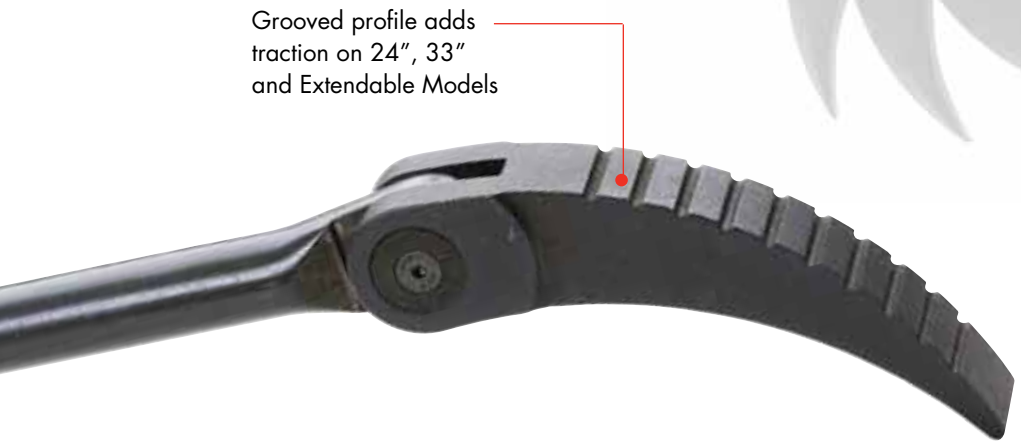



Extendable pry bar extends for greater access and leverage and collapses so you can store it securely in your tool box



Extends from 29" to 48"

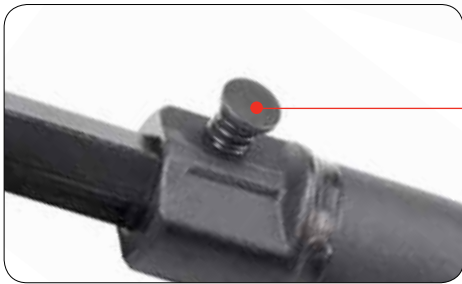

Push button to extend reach

INDEXIBLE NAIL PULLER



14 Locking positions for unmatched access

12" Long Handle for Access

Striking Face

Indexes to 180°

Fits Nail Sizes 4D to 10D

Products are covered by one or more of the following patents:
• US 6,840,141

PRY BARS



82300 - 2 Pc. Pry Bar Set

Item No.	Description
82216	16" Indexing Pry Bar
82208	8" Indexing Pry Bar



82301 - 3 Pc. Pry Bar Set

Item No.	Description
82216	16" Indexing Pry Bar
82210	10" Indexing Pry Bar
82208	8" Indexing Pry Bar



Open Stock - Indexing Pry Bar

Item No.	Description
82208	8" Indexing Pry Bar
82210	10" Indexing Pry Bar
82216	16" Indexing Pry Bar
82224	24" Indexing Pry Bar
82233	33" Indexing Pry Bar



Open Stock - Extendable Pry Bar

Item No.	Description
82220	18" to 29" Extendable Pry Bar
82248	29" to 48" Extendable Pry Bar



82212 - 12" Index Nail Puller

- Fits nail sizes 4D to 10D
- Indexible to 180°
- 14 locking positions

STRIKING & STRUCK TOOLS



Striking Tools

- Hammers
- Automotive Body Tools

Struck Tools

- Punches
- Chisels
- Punch & Chisel Holder



CHISELS AND PUNCHES

AVAILABLE IN:

- Cold Chisels
- Center Punches
- Pin Punches
- Long Taper Punches
- Starter Punches

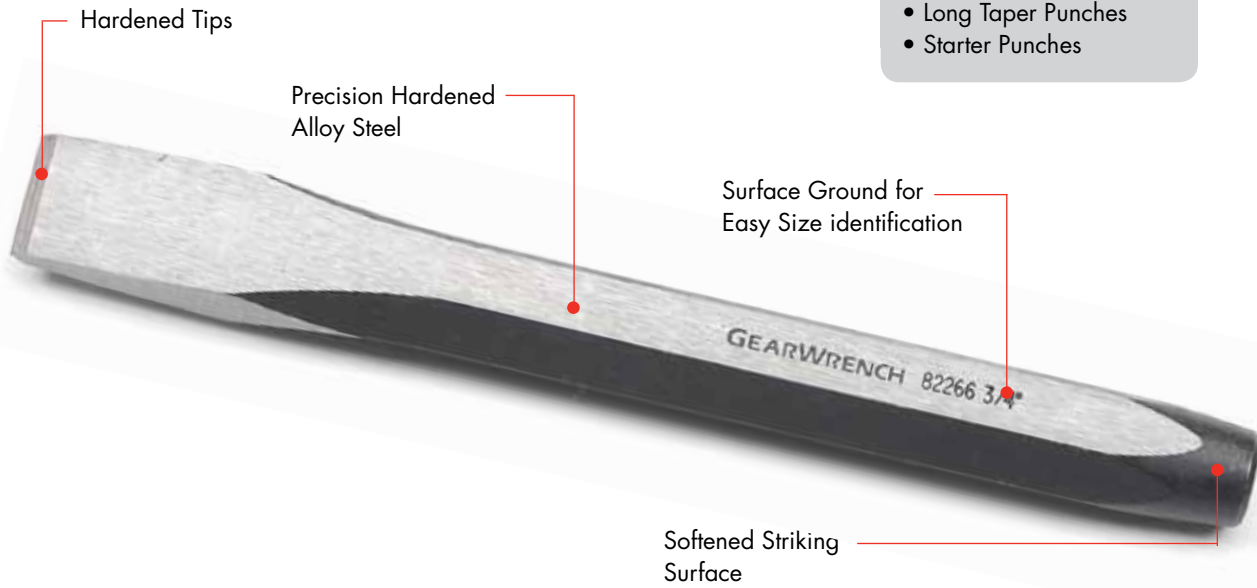

STRIKING & STRUCK TOOLS

HAMMERS

AVAILABLE IN:

- Ball Pein
- Curved Claw
- Drilling
- Dead Blow
- Rubber Mallet
- Soft or Hard Face



82303 - 5 Pc. Hammer Set

Item No.	Description
82251	16 oz. Ball Pein Hammer - Fiberglass
82255	3 lb Drilling Hammer
82260	12 oz. Soft Face Hammer - Removable Caps
82256	16 oz. Dead Blow Hammer - Composite Handle
82259	16 oz. Rubber Mallet - Wood Hickory Handle



82288 - 5 Pc. Ball Pein Hammer Set

Item No.	Description
82251	16 oz. Ball Pein Hammer - Fiberglass
82250	8 oz. Ball Pein Hammer - Fiberglass
82253	32 oz. Ball Pein Hammer - Fiberglass
82252	24 oz. Ball Pein Hammer - Fiberglass
82260	12 oz. Soft Face Hammer - Removable Caps



Open Stock - Ball Pein Hammers

Item No.	Description
82250	8 oz. Ball Pein Hammer - Fiberglass
82251	16 oz. Ball Pein Hammer - Fiberglass
82252	24 oz. Ball Pein Hammer - Fiberglass
82253	32 oz. Ball Pein Hammer - Fiberglass

- Use with struck tools, machine work, auto body, riveting, shaping metal



82254 - 16 oz. Claw Hammer Curved Claw - Fiberglass

- Driving nails, construction, multi-use, but not for punches and chisels



OPEN STOCK
STRIKING & STRUCK TOOLS



82255 - 3 lb Drilling Hammer

- For heavy duty use with punches, chisels, and star drills



82289 - 3 lb Engineers Hammer



82291 - 40 oz. Blacksmiths Hammer



82259 - 16 oz. Rubber Mallet - Wood Hickory Handle



82260 - 12 oz. Soft Face Hammer

- For light assembly applications where condition of work piece is important

Open Stock - Dead Blow Hammers

Item No.	Description
82258	48 oz. Dead Blow Hammer - Composite Handle
82256	16 oz. Dead Blow Hammer - Composite Handle
82257	32 oz. Dead Blow Hammer - Composite Handle

- **Multi-use applications in assembly, maintenance, production**



82306 - 27 Pc. Punch and Chisel Set

Item No.	Description
82261	1/4" x 4-3/4" x 1/4" Cold Chisel
82262	3/8" x 5" x 5/16" Cold Chisel
82263	7/16" x 5-1/2" x 3/8" Cold Chisel
82264	1/2" x 6" x 3/8" Cold Chisel
82265	5/8" x 6-1/2" x 3/8" Cold Chisel
82266	3/4" x 7" x 5/8" Cold Chisel
82267	7/8" x 7-1/2" x 3/4" Cold Chisel
82268	1" x 8" x 7/8" Cold Chisel
82269	1/4" x 4-1/4" Center Punch
82270	3/8" x 5" Center Punch
82271	7/16" x 5-1/2" Center Punch
82272	3/32" x 4-3/4" x 5/16" Pin Punch
82273	1/8" x 5" x 5/16" Pin Punch
82274	5/32" x 5-1/4" x 5/16" Pin Punch
82275	3/16" x 5-1/2" x 5/16" Pin Punch
82276	1/4" x 7" x 3/8" Pin Punch
82277	5/16" x 7" x 1/2" Pin Punch
82278	1/8" x 8" x 3/8" Long Taper Punch
82279	5/32" x 8-1/2" x 1/2" Long Taper
82280	3/16" x 9" x 1/2" Long Taper Punch
82281	1/4" x 11" x 5/8" Long Taper Punch
82282	5/32" x 5" x 3/8" Starter Punch
82283	3/16" x 5" x 3/8" Starter Punch
82284	1/4" x 6" x 1/2" Starter Punch
82285	1/8" x 4-1/2" x 5/16" Starter
82286	5/16" x 7" x 5/8" Starter Punch
82287	3/8" x 8" x 3/4" Starter Punch



OPEN STOCK

STRIKING & STRUCK TOOLS



82305 - 12 Pc. Punch and Chisel Set

Item No.	Description
82261	1/4" x 4-3/4" x 1/4" Cold Chisel
82262	3/8" x 5" x 5/16" Cold Chisel
82264	1/2" x 6" x 3/8" Cold Chisel
82265	5/8" x 6-1/2" x 3/8" Cold Chisel
82270	3/8" x 5" Center Punch
82272	3/32" x 4-3/4" x 5/16" Pin Punch
82273	1/8" x 5" x 5/16" Pin Punch
82274	5/32" x 5-1/4" x 5/16" Pin Punch
82275	3/16" x 5-1/2" x 5/16" Pin Punch
82278	1/8" x 8" x 3/8" Long Taper Punch
82283	3/16" x 5" x 3/8" Starter Punch
82285	1/8" x 4-1/2" x 5/16" Starter



82304 - 5 Pc. Punch and Chisel Set

Item No.	Description
82270	3/8" x 5" Center Punch
82273	1/8" x 5" x 5/16" Pin Punch
82274	5/32" x 5-1/4" x 5/16" Pin Punch
82275	3/16" x 5-1/2" x 5/16" Pin Punch
82264	1/2" x 6" x 3/8" Cold Chisel



82308 - 4 Pc. Cold Chisel Set

Item No.	Description
82263	7/16" x 5-1/2" x 3/8" Cold Chisel
82264	1/2" x 6" x 3/8" Cold Chisel
82265	5/8" x 6-1/2" x 3/8" Cold Chisel
82266	3/4" x 7" x 5/8" Cold Chisel

82309 - 5 Pc. Pin Punch Set

Item No.	Description
82273	1/8" x 5" x 5/16" Pin Punch
82274	5/32" x 5-1/4" x 5/16" Pin Punch
82275	3/16" x 5-1/2" x 5/16" Pin Punch
82276	1/4" x 7" x 3/8" Pin Punch
82277	5/16" x 7" x 1/2" Pin Punch



82307 - 4 Pc. Long Taper Punch Set

Item No.	Description
82278	1/8" x 8" x 3/8" Long Taper Punch
82279	5/32" x 8-1/2" x 1/2" Long Taper
82280	3/16" x 9" x 1/2" Long Taper Punch
82281	1/4" x 11" x 5/8" Long Taper Punch



84090 - Punch & Chisel Holder



Open Stock - Cold Chisels

Item No.	Description
82261	1/4" x 4-3/4" x 1/4" Cold Chisel
82262	3/8" x 5" x 5/16" Cold Chisel
82263	7/16" x 5-1/2" x 3/8" Cold Chisel
82264	1/2" x 6" x 3/8" Cold Chisel
82265	5/8" x 6-1/2" x 3/8" Cold Chisel
82266	3/4" x 7" x 5/8" Cold Chisel
82267	7/8" x 7-1/2" x 3/4" Cold Chisel
82268	1" x 8" x 7/8" Cold Chisel



- Designed to cut metal such as wrought iron, steel, brass, aluminum, as well as rivets, bolts and nuts



Open Stock - Center Punches

Item No.	Description
82269	1/4" x 4-1/4" Center Punch
82270	3/8" x 5" Center Punch
82271	7/16" x 5-1/2" Center Punch

- Used for marking center lines and pilot drill locations



Open Stock - Pin Punches

Item No.	Description
82272	3/32" x 4-3/4" x 5/16" Pin Punch
82273	1/8" x 5" x 5/16" Pin Punch
82274	5/32" x 5-1/4" x 5/16" Pin Punch
82275	3/16" x 5-1/2" x 5/16" Pin Punch
82276	1/4" x 7" x 3/8" Pin Punch
82277	5/16" x 7" x 1/2" Pin Punch

- Used for final removal to drive out pins and rivets



Open Stock - Long Taper Punches

Item No.	Description
82278	1/8" x 8" x 3/8" Long Taper Punch
82279	5/32" x 8-1/2" x 1/2" Long Taper
82280	3/16" x 9" x 1/2" Long Taper Punch
82281	1/4" x 11" x 5/8" Long Taper Punch

- Used to install and remove pins and shafts and to align holes



Open Stock - Starter Punches

Item No.	Description
82282	5/32" x 5" x 3/8" Starter Punch
82283	3/16" x 5" x 3/8" Starter Punch
82284	1/4" x 6" x 1/2" Starter Punch
82285	1/8" x 4-1/2" x 5/16" Starter Punch
82286	5/16" x 7" x 5/8" Starter Punch
82287	3/8" x 8" x 3/4" Starter Punch

- Designed for both starting and installing pins and rivets

82200 - 18" Rolling Wedge bar



82302 - 7 Pc. Body Tool Set

Item No.	Description
3719	Smooth Faced Bumping Hammer with Square & Round Face
3718	Smooth Faced Cross Chisel Hammer
3720	Cross Faced Shrinking Hammer
3725	Wedge Dolly
3724	General Purpose Dolly
3722	Toe Dolly
3723	Heel Dolly



OPEN STOCK

STRIKING & STRUCK TOOLS

3718 - Smooth Faced Cross Chisel Hammer



3719 - Smooth Faced Bumping Hammer with Square & Round Face



OPEN STOCK

STRIKING & STRUCK TOOLS



3720 - Cross Faced Shrinking Hammer



3722 - Toe Dolly



3723 - Heel Dolly



3724 - General Purpose Dolly



3725 - Wedge Dolly

RATCHETING TAPS & DIES



Tap & Die Tools

Ratcheting Tap & Die Sets
Extension Adapter Sets
T-Wrenches

Adapters
Tap Replacement Parts
Die Replacement Parts

RATCHETING TAP AND DIE DRIVE TOOLS

RATCHETING TAPS & DIES



Auto locking feature allows for safe removal of tap adapter

Spring-loaded cap allows for quick-release of large tap adapter

Extension adapters provide access in tight confined areas

Extend the length of tap and die system by combining adapters and any standard 3/8" drive extension.

Works on round and hex shaped dies

Die adapter works with Pass-Thru® Ratchet and Socket System as well as Vortex™ socket accessories.

5° Ratcheting arc with reversible lever eliminates hand over hand turning

Patented Twist Lock Guide System reduces "back walk" of die guard



Products are covered by one or more of the following patents:

- US 6,868,759
- US 7,231,851
- US 7,168,346

82812 - 114 Pc. MASTER Ratcheting Tap and Die Set SAE/METRIC

Item No.	Description
82800	Large Tap and Die Ratcheting "T" Wrench
82801	Large Locking Tap Adapter
82802	Large Hex Die Adapter
3881	Medium Tap and Die Ratcheting "T" Wrench
3883	Medium Tap Adapter
3882	Small Tap Adapter
3884	Medium Hex Die Adapter
82803	Male Extension Adapter - 3/8" Drive
82804	Female Extension Adapter - 3/8" Drive
	Sliding "T" for Adapters
	4mm Hex Key
	5 Screw Extractors
	Metric Thread Gauge
	SAE Thread Gauge



Taps

5/16 - 18 NC taper	1/8 - 28 BSP
5/16 - 24 NF plug	3 x .50 taper
3/8 - 16 NC plug	3 x .60 taper
3/8 - 24 NF plug	4 x .70 taper
7/16 - 14 NC plug	4 x .75 taper
7/16 - 20 NF plug	5 x .80 taper
1/2 - 13 NC plug	5 x .90 taper
1/2 - 20 NF plug	6 x .100 taper
1/8 - 27 NTP	7 x 1.00 taper
4 - 40 taper	1/4 - 19 BSP
6 - 32 taper	9/16 - 18 NF plug
8 - 32 taper	9/16 - 12 NC plug
10 - 24 taper	5/8 - 11 NC plug
10 - 32 taper	5/8 - 18 NF plug
12 - 24 taper	14 x 1.25 plug
1/4 - 20 NC taper	14 x 2.00 plug
1/4 - 28 NF taper	16 x 1.50 plug
8 x 1.25 plug	18 x 1.50 plug
9 x 1.00 plug	18 x 2.50 plug
9 x 1.25 plug	16 x 2.00 plug
10 x 1.25 plug	3/4 - 10 NC plug
10 x 1.50 plug	3/4 - 16 NF plug
11 x 1.50 plug	1/4 - 18 NPT
12 x 1.50 plug	
12 x 1.75 plug	

Hex Dies

4 - 40 taper	16 x 2.00 plug
6 - 32 taper	18 x 1.50 plug
8 - 32 taper	18 x 2.50 plug
10 - 24 taper	1/4 - 19 BSP
10 - 32 taper	9 x 1.25 plug
12 - 24 taper	10 x 1.25 plug
1/4 - 20 NC taper	10 x 1.50 plug
1/4 - 28 NF taper	11 x 1.50 plug
5/16 - 18 NC taper	12 x 1.50 plug
5/16 - 24 NF taper	12 x 1.75 plug
3/8 - 16 NC plug	1/8 - 28 BSP
3/8 - 24 NF plug	14 x 1.25 plug
7/16 - 14 NC plug	14 x 2.00 plug
7/16 - 20 NF plug	3 x .50 taper
1/2 - 13 NC plug	3 x .60 taper
1/2 - 20 NF plug	4 x .70 taper
9/16 - 12 NC plug	4 x .75 taper
9/16 - 18 NF plug	5 x .80 taper
5/8 - 11 NC plug	5 x .90 taper
5/8 - 18 NF plug	6 x 1.00 taper
3/4 - 10 NC plug	7 x 1.00 taper
3/4 - 16 NF plug	8 x 1.25 plug
1/8 - 27 NPT	9 x 1.00 plug
1/4 - 18 NPT	
16 x 1.50 plug	



3887 - 75 Pc. Medium Ratcheting Tap and Die Drive Tool Set SAE/METRIC

Item No.	Description
3881	Medium Tap and Die Ratcheting "T" Wrench
3882	Small Tap Adapter
3883	Medium Tap Adapter
3884	Medium Hex Die Adapter
	Sliding "T" for adapters
	SAE screw pitch gauge
	METRIC screw pitch gauge
	#5 screwdriver

SETS
RATCHETING TAPS & DIES

Taps

1/4 - 20 NC taper	1/4 - 20 NC taper
1/4 - 28 NF taper	1/4 - 28 NF taper
5/16 - 18 NC taper	5/16 - 18 NC taper
5/16 - 24 NF taper	5/16 - 24 NF taper
3/8 - 16 NC plug	3/8 - 16 NC plug
3/8 - 24 NF plug	3/8 - 24 NF plug
7/16 - 14 NC plug	7/16 - 14 NC plug
7/16 - 20 NF plug	7/16 - 20 NF plug
1/2 - 13 NC plug	1/2 - 13 NC plug
1/2 - 20 NF plug	1/2 - 20 NF plug
4 - 40 taper	4 - 40 taper
6 - 32 taper	6 - 32 taper
8 - 32 taper	8 - 32 taper
10 - 24 taper	10 - 24 taper
10 - 32 taper	10 - 32 taper
12 - 24 taper	12 - 24 taper
1/8 - 27 NPT	1/8 - 27 NPT

Hex Dies

1/4 - 20 NC	3 x .50 taper
1/4 - 28 NF	3 x .60 taper
5/16 - 18 NC	4 x .70 taper
5/16 - 24 NF	4 x .75 taper
3/8 - 16 NC	5 x .80 taper
3/8 - 24 NF	5 x .90 taper
7/16 - 14 NC	6 x 1.00 taper
7/16 - 20 NF	7 x 1.00 taper
1/2 - 13 NC	8 x 1.25 plug
1/2 - 20 NF	9 x 1.00 plug
4 - 40 taper	9 x 1.25 plug
6 - 32 taper	10 x 1.25 plug
8 - 32 taper	10 x 1.50 plug
10 - 24 taper	11 x 1.50 plug
10 - 32 taper	12 x 1.50 plug
12 - 24 taper	12 x 1.75 plug
1/8 - 27 NPT	1/8 - 28BSP

3885 - 40 Pc. Medium Ratcheting Tap and Die Drive Tool Set SAE

Item No.	Description
3881	Medium Tap and Die Ratcheting "T" Wrench
3882	Small Tap Adapter
3883	Medium Tap Adapter
3884	Medium Hex Die Adapter
	Sliding "T" for adapters
	Thread gauge
	#5 screwdriver

Taps

1/4 - 20 NC taper
1/4 - 28 NF taper
5/16 - 18 NC taper
5/16 24 NF taper
3/8 - 16 NC plug
3/8 - 24 NF plug
7/16 -14 NC plug
7/16 - 20 NF plug
1/2 - 13 NC plug
1/2 - 20 NF plug
4 - 40 taper
6 - 32 taper
8 - 32 taper
10 - 24 taper
10 - 32 taper
12 - 24 taper
1/8 - 27 NPT

Hex Dies

1/4 - 20 NC
1/4 - 28 NF
5/16 - 18 NC
5/16 - 24 NF
3/8 - 16 NC
3/8 - 24 NF
7/16 -14 NC
7/16 - 20 NF
1/2 -13 NC
1/2 - 20 NF
4 - 40 taper
6 - 32 taper
8 - 32 taper
10 - 24 taper
10 - 32 taper
12 - 24 taper
1/8 - 27 NPT



SETS

RATHETING TAPS & DIES



3886 - 40 Pc. Medium Ratcheting Tap and Die Drive Tool Set METRIC

Item No.	Description
3881	Medium Tap and Die Ratcheting "T" Wrench
3882	Small Tap Adapter
3883	Medium Tap Adapter
3884	Medium Hex Die Adapter
	Sliding "T" for adapters
	Thread gauge
	#5 screwdriver

Taps	Hex Dies
3 x .50 taper	3 x .60
3 x .60 taper	4 x .70
4 x .70 taper	4 x .75
4 x .75 taper	5 x .80
5 x .80 taper	5 x .90
5 x .90 taper	6 x 1.00
6 x 1.00 taper	7 x 1.00
7 x 1.00 taper	8 x 1.25
8 x 1.25 plug	9 x 1.00
9 x 1.00 plug	9 x 1.25
9 x 1.25 plug	10 x 1.25
10 x 1.25 plug	10 x 1.50
10 x 1.50 plug	11 x 1.50
11 x 1.50 plug	12 x 1.50
12 x 1.50 plug	12 x 1.75
12 x 1.75 plug	1/8 - 28BSP

SETS
RATCHETING TAPS & DIES

PATENTED

82811 - 65 Pc. Ratcheting Tap and Die Set SAE

Item No.	Description
82800	Large Tap and Die Ratcheting "T" Wrench
82801	Large Locking Tap Adapter
82802	Large Hex Die Adapter
3881	Medium Tap and Die Ratcheting "T" Wrench
3883	Medium Tap Adapter
3882	Small Tap Adapter
3884	Medium Hex Die Adapter
82803	Male Extension Adapter - 3/8" Drive
82804	Female Extension Adapter - 3/8" Drive
	Sliding "T" for Adapters
	4mm Hex Key
	5 Screw Extractors
	SAE Thread Gauge

Taps

1/4 - 18 NC taper
9/16 - 18 NF plug
5/8 - 11 NC plug
5/8 - 18 NF plug
1/8 - 27 NPT
5/16 - 18 NC taper
5/16 - 24 NF taper
3/8 - 16 NC plug
3/8 - 24 NF plug
7/16 - 14 NC plug
7/16 - 20 NF plug
1/2 - 13 NC plug
1/2 - 20 NF plug
4 - 40 taper
6 - 32 taper
8 - 32 taper
10 - 24 taper
10 - 32 taper
12 - 24 taper
1/4 - 20 NC taper
1/4 - 28 NF taper
3/4 - 10 NC plug
3/4 - 16 NF plug
1/8 - 27 NPT

Hex Dies

4 - 40 taper
5/16 - 18 NC taper
5/16 - 24 NF taper
3/8 - 16 NC plug
3/8 - 24 NF plug
7/16 - 14 NC plug
7/16 - 20 NF plug
1/2 - 13 NC plug
1/2 - 20 NF plug
6 - 32 taper
8 - 32 taper
10 - 24 taper
10 - 32 taper
12 - 24 taper
1/4 - 20 NC taper
1/4 - 28 NF taper
9/16 - 12 NC plug
9/16 - 18 NF plug
5/8 - 11 NC plug
5/8 - 18 NF plug
3/4 - 10 NC plug
3/4 - 16 NF plug
1/8 - 27 NPT
1/4 - 18 NPT



SETS

RATHETING TAPS & DIES



82810 - 65Pc. Ratcheting Tap and Die Set METRIC

Item No.	Description
82800	Large Ratcheting "T" Wrench
82801	Large Locking Tap Adapter
82802	Large Hex Die Adapter
3881	Medium Tap and Die Ratcheting "T" Wrench
3883	Medium Tap Adapter
3882	Small Tap Adapter
3884	Small Die Adapter
82803	Male Extension Adapter - 3/8" Drive
82804	Female Extension Adapter - 3/8" Drive
	Sliding "T" for Adapters
	4mm Hex Key
	5 Screw Extractors
	Metric Thread Gauge

Taps

- 3 x .50 taper
- 3 x .60 taper
- 4 x .70 taper
- 4 x .75 taper
- 5 x .80 taper
- 5 x .90 taper
- 6 x 1.00 taper
- 7 x 1.00 taper
- 8 x 1.25 plug
- 9 x 1.00 plug
- 9 x 1.25 plug
- 10 x 1.25 plug
- 10 x 1.50 plug
- 11 x 1.50 plug
- 12 x 1.50 plug
- 12 x 1.75 plug
- 14 x 1.25 plug
- 14 x 2.00 plug
- 16 x 1.50 plug
- 16 x 2.00 plug
- 18 x 1.50 plug
- 18 x 2.50 plug
- 1/8 - 28 BSP
- 1/4 - 19 BSP

Hex Dies

- 3 x .50
- 3 x .60
- 4 x .70
- 4 x .75
- 5 x .80
- 5 x .90
- 6 x 1.00
- 7 x 1.00
- 8 x 1.25
- 9 x 1.00
- 9 x 1.25
- 10 x 1.25
- 10 x 1.50
- 11 x 1.50
- 12 x 1.50
- 12 x 1.75
- 14 x 1.25
- 14 x 2.00
- 16 x 1.50
- 16 x 2.00
- 18 x 1.50
- 18 x 2.50
- 1/8 - 28 BSP
- 1/4 - 19 BSP

SETS
RATCHETING TAPS & DIES

82808 - 17 Pc. Large Ratcheting Tap and Die Set SAE

Item No.	Description
82800	Large Ratcheting "T" Wrench
82801	Large Locking Tap Adapter
82802	Large Hex Die Adapter
	SAE Thread Gauge
	4mm Hex Key

Taps	Hex Dies
9/16 - 12 NC plug	9/16 - 12 NC
9/16 - 18 NF plug	9/16 - 18 NF
5/8 - 11 NC plug	5/8 - 11 NC
5/8 - 18 NF plug	5/8 - 18 NF
3/4 - 10 NC plug	3/4 - 10 NC
3/4 - 16 NF plug	3/4 - 16 NF



82809 - 17 Pc. Large Ratcheting Tap and Die Set METRIC

Item No.	Description
82800	Large Ratcheting "T" Wrench
82801	Large Locking Tap Adapter
82802	Large Hex Die Adapter
	Metric Thread Gauge
	4mm Hex Key

Taps	Hex Dies
14 x 1.25 plug	14 x 1.25 plug
14 x 2.00 plug	14 x 2.00 plug
16 x 1.50 plug	16 x 1.50 plug
16 x 2.00 plug	16 x 2.00 plug
18 x 1.50 plug	18 x 1.50 plug
18 x 2.50 plug	18 x 2.50 plug





PATENTED

82807 - 11 Pc. Master Ratcheting Tap and Die Drive Tool Set

Item No.	Description
82800	Large Ratcheting "T" Wrench
82801	Large Locking Tap Adapter
82802	Large Hex Die Adapter
3881	Medium Ratcheting "T" Wrench
3883	Medium Tap Adapter
3882	Small Tap Adapter
3884	Medium Hex Die Adapter
82803	Male Extension Adapter - 3/8" Drive
82804	Female Extension Adapter - 3/8" Drive
	Sliding "T" for Adapters
	4mm Hex Key



PATENTED

3880 - 5 Pc. Medium Ratcheting Tap and Die Drive Tool Set

Item No.	Description
3881	Medium Ratcheting "T" Wrench
3882	Small Tap Adapter
3883	Medium Tap Adapter
3884	Medium Hex Die Adapter
	Sliding "T" for Adapters



PATENTED

82806 - 4 Pc. Large Ratcheting Tap and Die Drive Tool Set

Item No.	Description
82800	Large Ratcheting "T" Wrench
82801	Large Locking Tap Adapter
82802	Large Hex Die Adapter
	4mm Hex Key

82805 - 2 Pc. Ratcheting Tap and Die 3/8" Drive Extension Adater Set

Item No.	Description
82803	Male Extension Adapter - 3/8" Drive
82804	Female Extension Adapter - 3/8" Drive



PATENTED

Open Stock - Ratcheting "T" Wrench

Item No.	Description
3881	Medium Ratcheting "T" Wrench
82800	Large Ratcheting "T" Wrench



PATENTED

Open Stock - Tap Adapter

Item No.	Description
3882	Small Tap Adapter
3883	Medium Tap Adapter



PATENTED

82801 - Large Locking Tap Adapter

- Accomodates taps up to 9/16" - 3/4" and 14mm - 18mm.



PATENTED

Open Stock - Hex Die Adapter

Item No.	Description
3884	Medium Hex Die Adapter
82802	Large Hex Die Adapter



PATENTED

	Sizes	
	SAE	METRIC
Small Tap Adapter	4 - 40 - 12 - 24	
Medium Tap Adapter	1/4" - 1/2"	3mm - 12mm
Large Tap Adapter	9/16" - 3/4"	14mm - 18mm
Medium Hex Die Adapter	1/4" - 1/2"	3mm - 12mm
Large Hex Die Adapter	9/16" - 3/4"	14mm - 18mm



Open Stock - Die Replacement Parts

Item No.	Description
388735	4 x 40 NC Single Hex Die
388736	6 x 32 NC Single Hex Die
388737	8 x 32 NC Single Hex Die
388738	10 x 24 NC Single Hex Die
388739	10 x 32 NF Single Hex Die
388740	12 x 24 NC Single Hex Die
388741	14 x 20 NC Single Hex Die
388742	1/4" x 28 NF Single Hex Die
388743	5/16" x 18 NC Single Hex Die

Item No.	Description
388744	5/16" x 24 NF Single Hex Die
388745	3/8" x 16 NC Single Hex Die
388746	3/8" x 24 NF Single Hex Die
388747	7/16" x 14 NC Single Hex Die
388748	7/16" x 20 NF Single Hex Die
388749	1/2" x 13 NC Single Hex Die
388750	1/2" x 20 NF Single Hex Die
388751	3 mm x .50 Die
388752	3 mm x .60 Die
388753	4 mm x .70 Die
388754	4 mm x .75 Die
388755	5 mm x .80 Die
388756	5 mm x .90 Die
388757	6 mm x 1.00 Die
388758	7 mm x 1.00 Die
388759	8 mm x 1.25 Die

Item No.	Description
388760	9 mm x 1.00 Die
388761	9 mm x 1.25 Die
388762	10 mm x 1.25 Die
388763	10 mm x 1.50 Die
388764	11 mm x 1.50 Die
388765	12 mm x 1.50 Die
388766	12 mm x 1.75 Die
82863	9/16 12 NC Single Hex Die
82864	9/16 18 NF Single Hex Die
82865	5/8 11NC Single Hex Die
82866	5/8 18 NF Single Hex Die
82867	3/4 10 NC Single Hex Die
82868	3/4 16 NF Single Hex Die
82869	1/4 18 NPT PIPE Hex Die
388768	1/8" x 28 BSP Pipe Hex Die



Open Stock - Tap Replacement Parts

Item No.	Description
388701	4 x 40 NC Plug Tap
388702	6 x 32 NC Plug Tap
388703	8 x 32 NC Plug Tap
388704	10 x 24 NC Plug Tap
388705	10 x 32 NF Plug Tap
388706	12 x 24 NC Plug Tap
388707	1/4" x 20 NC HSS Plug Tap
388708	1/4" x 28 NF HSS Plug Tap
388709	5/16" x 18 NC Plug Tap
388710	5/16" x 24 NF Plug Tap
388711	3/8" x 16 NC Plug Tap

Item No.	Description
388712	3/8" x 24 NF Plug Tap
388713	7/16" x 14 NC Plug Tap
388714	7/16" x 20 NF Plug Tap
388715	1/2" x 13 NC Plug Tap
388716	1/2" x 20 NF Plug Tap
388733	1/8" x 28 BSP Pipe Tap
388734	1/8" x 27 NPT HSS Pipe Tap
388717	3 mm x .50 Plug Tap
388718	3 mm x .60 Plug Tap
388719	4 mm x .70 Plug Tap
388720	4 mm x .75 Plug Tap
388721	5 mm x .80 Plug Tap
388722	5 mm x .90 Plug Tap
388723	6 mm x 1.00 Plug Tap
388724	7 mm x 1.00 Plug Tap
388725	8 mm x 1.25 Plug Tap
388726	9 mm x 1.00 Plug Tap
388727	9 mm x 1.25 Plug Tap

Item No.	Description
388728	10 mm x 1.25 Plug Tap
388729	10 mm x 1.50 Plug Tap
388730	11 mm x 1.50 Plug Tap
388731	12 mm x 1.50 Plug Tap
388732	12 mm x 1.75 Plug Tap
82850	14 x 1.25 mm Plug Tap
82851	14 x 2.00 mm Plug Tap
82852	16 x 1.50 mm Plug Tap
82853	16 x 2.00 mm Plug Tap
82854	18 x 1.50 mm Plug Tap
82855	18 x 2.50 mm Plug Tap
82856	9/16 12 NC Plug
82857	9/16 18 NF Plug
82858	5/8 11 NC Plug
82859	5/8 18 NF Plug
82860	3/4 10 NC Plug
82861	3/4 16 NF Plug
82862	1/4 18 NPT PIPE Tap

* All taps and dies are Carbon Steel

CUTTING TOOLS



Cutting Tools

Hack Saw
Utility Knife
Files
Snips
Cable Cutter



82880 - High Tension Hacksaw

- High tension design works with Carbon Steel and Bi-metal blades.
- Flush cut 45 degree angles.
- Strong tubular frame.
- Dual grips front and back offer additional control.



82881 - Folding Utility Knife

- 3" lock blade with serrated edge for rough cuts.
- Standard folding utility knife for sharper, delicate cuts.
- Easy blade release.
- Dual material body.
- Storage pouch included.



82820 - 4 Pc. Standard Bastard Files Set

Item No.	Description
82822	8" Flat File
82823	8" Round File
82824	8" Half Round File
82825	8" Triangle File



82821 - 6 Pc. Mini Bastard Files Set

Item No.	Description
82826	4" Flat Mini File
82827	4" Half Round Mini File
82828	4" Round Mini File
82829	4" Triangle Mini File
82830	4" Square Mini File
82831	4" Knife Mini File

CUTTING TOOLS

82822 - 8" Flat Bastard File

- A workhorse file for removing flash and other particles.
- Overall length 12.75", Weight 0.45 lbs.



82823 - 8" Round Bastard File

- For enlarging curved or round openings.
- Overall Length 12.75", Weight 0.30 lbs.



82824 - 8" Half Round Bastard File

- Provides spiral cut for smooth finish. Curved on one side and flat on the other.
- Overall length 12.75", Weight 0.45 lbs.



82825 - 8" Triangle Bastard File

- Used for cutting and cleaning corners.
- Overall length 12.75", Weight 0.45 lbs.



82826 - 4" Flat Mini Bastard File

- Offers precision file applications on flat surfaces.
- Overall length 7.50", Weight 0.05 lbs.



82827 - 4" Half Round Mini Bastard File

- For curved and flat surfaces.
- Overall length 7.50", Weight 0.05 lbs.



82828 - 4" Round Mini Bastard File

- For curved surface or hole enlargement.
- Overall length 7.50", Weight 0.05 lbs.



82829 - 4" Triangle Mini Bastard File

- Use for cutting corners and in tight confines.
- Overall length 7.50", Weight 0.05 lbs.



82830 - 4" Square Mini Bastard File

- Versatile for corners or flat areas.
- Overall length 7.50", Weight 0.05 lbs.



82831 - 4" Knife Mini Bastard File

- Deep corners or for cutting grooves.
- Overall length 7.50", Weight 0.05 lbs.





82843 - 3 Pc. Aviation Snip Set

Item No.	Description
82840	Straight Cutting Aviation Snips
82841	Right Cutting Aviation Snips
82842	Left Cutting Aviation Snips

- Dual material comfort grip.
- Spring loaded.
- Serrated and hardened jaws for clean cuts.
- Quick color identification.



82840 - Straight Cutting Aviation Snips



82841 - Right Cutting Aviation Snips



82842 - Left Cutting Aviation Snips



82009 - 10" Cable Cutter

- Designed for cutting standard style cable.
- Dual material grip for comfort.
- Ideal for cutting battery cables.

SPECIALTY & GENERAL PURPOSE TOOLS

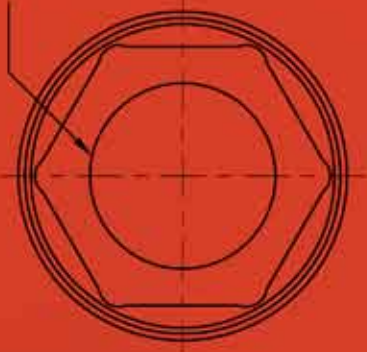

Specialty Tools

Oil Drain Plug Sockets
Serpentine Belt Tool
Hooks and Picks

Scrapers
Door Panel Removers
Trim Pad Tool

General Purpose Tools

Tape Measure
Flashlight
Gloves

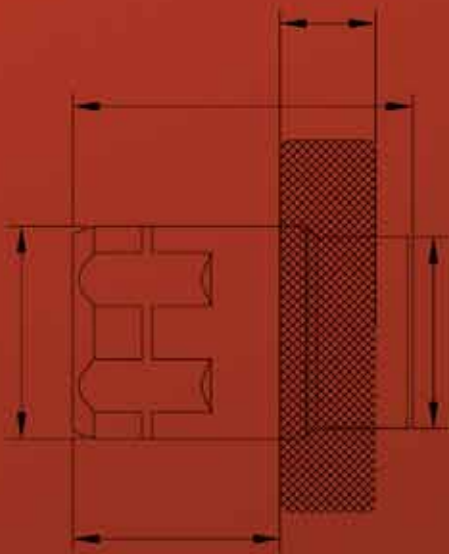

**OIL DRAIN
PLUG SOCKETS**

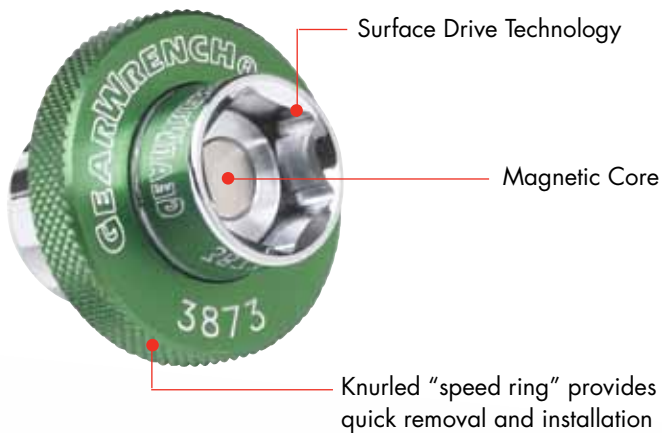

Can be used with Pass-Thru® Ratchets Featuring GearRatchet™ handles, or standard 3/8" Drive ratchets

SPECIALTY & GENERAL



Serrated edges provide added grip for those hard-to-reach fasteners

Products are covered by one or more of the following patents:

- US 7,159,491
- US 7,658,132



3680 - 15 Pc. Serpentine Belt Tool Set

Item No.	Description
3680-71	Long Bar
3680-72	GearWrench® Special Ratcheting Wrench
3680-73	3/8" Adapter
3680-74	1/2" Adapter
3680-75	3/4" Adapter
3680-76	6 Pt. 13 mm Socket
3680-77	6 Pt. 14 mm Socket
3680-78	6 Pt. 15 mm Socket
3680-79	6 Pt. 16 mm Socket
3680-80	6 Pt. 17 mm Socket
3680-81	6 Pt. 18 mm Socket
3680-82	6 Pt. 19 mm Socket
3680-83	13 mm Crowfoot
3680-84	14 mm Crowfoot
3680-85	15 mm Crowfoot



3870 - 7 Pc. Magnetic Oil Drain Plug Socket Set

Item No.	Description
235080GR	3/8" (20 mm) GearRatchet® Handle
3872	13 mm Magnetic Oil Drain Plug Socket
3873	14 mm Magnetic Oil Drain Plug Socket
3874	15 mm Magnetic Oil Drain Plug Socket
3875	16 mm Magnetic Oil Drain Plug Socket
3876	17 mm Magnetic Oil Drain Plug Socket
3877	19 mm Magnetic Oil Drain Plug Socket



3871 - 6 Pc. Magnetic Oil Drain Plug Socket Set

Item No.	Description
3872	13 mm Magnetic Oil Drain Plug Socket
3873	14 mm Magnetic Oil Drain Plug Socket
3874	15 mm Magnetic Oil Drain Plug Socket
3875	16 mm Magnetic Oil Drain Plug Socket
3876	17 mm Magnetic Oil Drain Plug Socket
3877	19 mm Magnetic Oil Drain Plug Socket





Open Stock - Magnetic Oil Drain Plug Sockets

Item No.	Description
3872	13 mm Magnetic Oil Drain Plug Socket
3873	14 mm Magnetic Oil Drain Plug Socket
3874	15 mm Magnetic Oil Drain Plug Socket
3875	16 mm Magnetic Oil Drain Plug Socket
3876	17 mm Magnetic Oil Drain Plug Socket
3877	19 mm Magnetic Oil Drain Plug Socket



84000 - 7 Pc. Hook & Pick Set

Item No.	Description
84001	5" Cotter Pin Puller
84002	4" Hose Pick Puller
84003	4-1/2" Awl
84004	3-1/8" Mini Full Hook
84005	3-1/8" 90° Mini Hook
84006	3-1/8" Straight Mini Hook
84007	3-1/8" Mini Offset Hook



84040 - 4 Pc. Mini Hook & Pick Set

Item No.	Description
84004	3-1/8" Mini Full Hook
84005	3-1/8" 90° Mini Hook
84006	3-1/8" Straight Mini Hook
84007	3-1/8" Mini Offset Hook

SPECIALTY & GENERAL OPEN STOCK

84001 - 5" Cotter Pin Puller

- Good for seal pick and other general cleaning projects including cotter pins.
- Overall Length 9.50", Weight 0.25 lbs.



84002 - 4" Hose Pick Puller

- Good for hose removal, spring clamps or other prying.
- Overall Length 8", Weight 0.20 lbs.



84003 - 4-1/2" Awl

- Use as scratch awl or hole punch.
- Overall Length 9.50", Weight 0.20 lbs.



84004 - 3-1/8" Mini Full Hook

- Good for hooking springs and other objects.
- Small size for tight access areas.
- Overall Length 6.50", Weight 0.05 lbs.



84005 - 3-1/8" 90° Mini Hook

- Use for seal pick removal.
- Overall Length 6.50", Weight 0.05 lbs.



84006 - 3-1/8" Straight Mini Hook

- Good to use as hole punch and mini scratch awl.
- Overall Length 6.50", Weight 0.05 lbs.



84007 - 3-1/8" Mini Offset Hook

- Use for seals and delicate cleaning applications.
- Overall Length 6.50", Weight 0.05 lbs.





84070 - 2 Pc. Scraper Set

Item No.	Description
84071	1" Reverse Scraper
84072	1" Offset Scraper



84080 - 4 Pc. Scraper Set

Item No.	Description
84081	1/4" x 8" Scraper
84082	1/2" x 8" Scraper
84083	1" x 8" Scraper
84084	1" x 3-3/4" Scraper



84060 - 4 Pc. Door Panel Kit

Item No.	Description
84061	20" Door Panel Remover
84063	Door Panel Remover - Square
84064	Door Panel Remover - V
84065	Trim Pad Tool



84062 - 10" Door Panel Remover - U



84050 - 4 Pc. Door Pad and Panel Removal Kit

Item No.	Description
84051	4" V-Notch Puller
84052	4" Square Notch Puller
84053	4" Scraper
84054	4" Curved Blade V-Notch Puller

SETS
SPECIALTY & GENERAL

84051 - 4" V-Notch Puller

- Minimize damage on door panels and other interior auto applications.
- Overall Length 8.63", Weight 0.20 lbs.



84052 - 4" Square Notch Puller

- Designed for offset applications and getting around obstacles.
- Overall Length 10.00", Weight 0.50 lbs.



84053 - 4" Scraper

- Use for general scraping applications.
- Overall Length 10.25", Weight 0.35 lbs.



84054 - 4" Curved Blade V-Notch Puller

- For hard to reach panel clips.
- Overall Length 9.50", Weight 0.40 lbs.



83131 - Tape Measure - 16 Ft

- 16' x 1-1/16" wide.
- Coated blade for durability.
- Stainless case.
- Rubber molded for comfort.



OPEN STOCK
SPECIALTY & GENERAL



83132 - Flashlight Aluminum

- Aluminum body with rubber grip.
- Five LED bulbs above 13000 mcd, white light.
- Weatherproof.
- Rubber ring around head of flashlight.
- Includes carry case.



86990 - Mechanics Gloves



86991 - Fender Cover

- Magnetic
- Oil Resistant
- Measure 34-1/2" W x 18-1/2" L

ALPHA INDEX

1/4" Drive Chrome	
Ratchets	68-69
Socket Sets	58-68
Sockets	72-76
3/8" Drive Chrome	
Ratchets	90-92
Socket Sets	77-90
Sockets	95-99
1/2" Drive Chrome	
Ratchets	112-113
Socket Sets	100-112
Sockets	116-119
3/4" Drive Chrome	
Ratchets	121
Socket Sets	120
Sockets	122
A	
Adapters	
1/4"	70
3/8"	94
1/2"	114
Ratcheting	243
Pass-Thru	130
Adjustable Wrenches	264, 265
B	
Body Tools	
331-332	
Bit Sockets	
Ball End Hex	141, 142, 149, 150
External Torx	136, 138, 140, 146, 152, 155
Hex	138, 139, 140, 141, 142, 143, 144, 148, 149, 150, 153
Bit Holders	147, 152
Long Ball	142, 149
Long Torx	137, 147, 152
Screwdriver	142, 153
Sets	134-143
Torx	136, 137, 138, 140, 143, 145, 146, 147, 151, 152, 154, 155
Triple Square	139, 140, 144, 150, 154
C	
Cable Cutter	
348	
Combination Wrenches - Ratcheting	
Combination Ratcheting	207-212
Flex Combination Ratcheting	222-225
Indexing Ratcheting	232, 233
Open End Ratcheting	234, 235
Ratcheting	226, 227
Reversible Combination Ratcheting	215-219
Stubby Combination Ratcheting	213, 214
Stubby Flex Combination Ratcheting	226, 227
XL Combination Ratcheting	202-206
XL Locking Flex Combination Ratcheting	220, 221
XL Spline Ratcheting	231
XL X-Beam Ratcheting	190-201
Combination Wrenches - Non-Ratcheting	
6 Pt. Combination	253-255
12 Pt. Long Pattern Combination	247-252
Stubby Combination	256, 257
XL X-Beam Non-Ratcheting	245, 246

Clips, Socket	36
Crowfoot Wrenches	260, 261
D	
Deep Offset Box End Wrenches	262
Dies	344
Door Panel Removers	354-355
Double Box, GearBox (XL)	228-230
Double Box, Half Moon	239, 240
Double Box, QuadBox	236, 238
Double Box, Ratcheting	238, 239
Double Box, S-Shaped	240, 241
Double-X Pliers	308-311
Drive Tools	
1/4" Drive	68-71
3/8" Drive	91-94
1/2" Drive	112-115
3/4" Drive	121
MultiDrive	54-57
E	
E-Torx Ratcheting Wrenches	242
External Torx Sockets	146, 152, 155
External Torx Socket Sets	136, 138, 140
Electronic Torque Wrenches	269, 270
Extensions	
1/4" Drive	70, 71
3/8" Drive	93, 94
1/2" Drive	114, 115
3/4" Drive	115
Impact	165, 172, 182, 189
MultiDrive	57
Vortex	130
F	
Fender Cover	
356	
Files	346-347
Flare Nut Wrenches	258, 260
Flashlight	356
Flex Flare Nut Wrenches	259
Flex Sockets	76, 99
Flex Socket Sets	67, 68, 89, 90
G	
GearBox Double Box Wrenches (XL)	228-230
GearRatchet™ Handle	126
Gloves	356
H	
Hacksaw	
346	
Half Moon Wrenches	239, 240
Hammers	
Ball Pein	325
Blacksmiths	326
Claw Hammer	325
Dead Blow	327
Drilling	326
Engineers	326
Rubber Mallet	326
Sets	325
Soft Face	326
Hex Bit Sockets	
Bit Sockets, Metric	144, 148, 153
Bit Sockets, SAE	144, 148, 154
Bit Sockets, Screwdriver	153

Hex (continued)	
Bit Sockets, Torx	145, 147, 151, 152, 154, 155
Bit Sockets, Triple Square	144, 150, 154
Bits, Replacements	147, 152
Bits, Vortex	129
Sets	134-143
Hex Keys - Flexible	156-158
Hooks & Picks	352, 353
I	
Impacts	
1/4" Drive	161-168
3/8" Drive	169-176
1/2" Drive	177-188
3/4" Drive	189-192
Adapters	166, 172, 182, 189
Extensions	165, 172, 182, 189
Hex Sockets	171, 175, 175, 180, 181, 187
Universal Joints	166, 173, 182
Universal Sockets	165, 168, 172, 176, 181, 188
K	
Knives	346
L	
Locking Extensions	71, 115
Locking Flex Wrenches (XL)	220, 221
M	
Magnetic Oil Drain Plug Socket Set	176
Magnetic Parts Tray	36
Mini Screwdrivers	277, 281, 282
Micrometer Torque Wrenches	269
Multi Drive Sets	
Introductory	13, 24
Career Builder Sets	14-17
Intermediate and Advanced Tool Sets	18-23, 25
N	
Nail Puller	
322	
Nut Drivers	
Non-Ratcheting	286-288, 289, 291
Ratcheting	298, 299
Shafts	300
O	
Oil Drain Plug Sockets, Magnetic	351, 352
Open End Non-Ratcheting Wrenches	263
Open End Ratcheting Wrenches	234, 235
P	
Parts Tray	36
Pass-Thru Ratchet & Socket Sets (XL)	124-126
Pliers	
Cushion Grip	308-315
Double-X	308-311
Dual Material	304-308
Hose Clamp	308
Insulated	315, 316
Locking	317, 318
Mini	307-308
Sets	304, 305, 308, 309, 311, 312, 315, 316, 317
Pry Bars	322, 331
Punch & Chisel	
Chisels	328, 329
Holder	329
Punches	329, 330,

Punch & Chisel (continued)	
Sets	327, 328
Q	
QuadBox Double Box Wrenches	236, 238
R	
Ratchets	
1/4" Drive	68, 69
3/8" Drive	90-92
1/2" Drive	112, 113
3/4" Drive	121
Sets	55, 56
Ratcheting Screwdrivers	294-297
Ratcheting Nut Drivers	298, 299
Reversible Combination Wrenches	215-219
S	
Scrapers	354
Serpentine Belt Tool Set	351
Screwdrivers	
Cabinet Tip	285
Cushion Grip	286-288
Dual Material	274-282
Insulated	289, 290
Mini	277, 281, 282
Nut Driver, Non-Ratcheting	286-288, 289, 291
Nut Driver, Ratcheting	298, 299
Phillips	279, 285, 287
Pozidriv	280
Ratcheting Screwdriver	294-297
Screw Holding Drivers	292
Solid Handle	283-285
Sets	148 - 152
Slotted	279, 284, 287
Torx	280
Sets, Socket Chrome	
Multi Drive	13-25, 40-54
1/4" Drive	58-68
3/8" Drive	77-90
1/2" Drive	100-112
3/4" Drive	120
Bit Socket	134-143
External Torx	136, 138, 140
Flex	67, 68, 89, 90
Sets, Socket Impact	
1/4" Drive	161-165
3/8" Drive	169-172
1/2" Drive	177-181
Sets, Wrenches	
Adjustable	264, 365
Combination, Ratcheting	207-210
Combination, Non-Ratcheting	247-251, 253, 254
Crowfoot	260-261
Deep Offset Box	262
Double Box Ratcheting	238, 239
E-Torx Ratcheting	242
Flare Nut	259
Flex Combination Ratcheting	223-224
Flex Flare Nut	258
Half-Moon Double Box Ratcheting	239
Indexing Ratcheting	232
Open End Non-Ratcheting	263

Sets, Wrenches (continued)	
Open End Ratcheting	234
QuadBox Double Box Ratcheting	236-238
Reversible Combination Ratcheting	215-218
S-Shape Double Box Ratcheting	240,241
Stubby Combination Ratcheting	213
Stubby Combination Non-Ratcheting	256
Stubby Flex Combination Ratcheting	226
XL Combination Ratcheting	202-205
XL GearBox Double Box Ratcheting	228,229
XL Locking Flex Combination Ratcheting	220
XL Spline Combination Wrenches	231
XL X-Beam Ratcheting	196-197
XL X-Beam Non-Ratcheting	245
Snips	348
Sockets	
1/4" Drive	72-76
3/8" Drive	95-99
1/2" Drive	116-119
3/4" Drive	122
Bit Sockets	144-154
Bit Holder Sockets	147, 152
External Torx Sockets	146, 152, 155
Flex Sockets	76,99
Magnetic Oil Drain Plug Sockets	352
Screwdriver Bit Sockets	68
Spark Plug Sockets	94
Torx Press Fit Bit Sockets	145,151,154
Torx Bit Sockets	145,146, 147, 151 152, 154, 155
Triple Square Bit Sockets	144,150,154
Torx Tamper-Proof	145,151
Vortex Bit Sockets	129
Vortex Sockets	127-128
Socket Clips	36
Socket Rails	36
Spark Plug Sockets	94
Spline Combination Wrenches (XL)	231
Stubby Wrenches	213,214,256,257,226,227
T	
Tape Measure	355
Taps	344
Tap and Die Sets	335-342
Tire Pressure Monitoring	270
Tool Storage	
Accessories	36
Ball Bearing Series	
Cabinets	33,34
Chests	33,34
Hand Boxes& Bags	35
XL Series	
Carts	32
Cabinets	30,31
Chests	30,31
Torque Wrenches	269-270
Torx Bit Socket Sets	136, 137, 138, 140, 143
Torx Keys	156, 157
Torx Screwdrivers	280
U	
Universal Joints	69,70,92,93,114
V	
Vortex Bit Sockets	
Bit Sockets	129
Sockets	127-128

W	
Wrenches	
Adjustable	264,265
Combination, Ratcheting	207-212
Combination, Non-Ratcheting	247-255
Crowfoot	260,261
Deep Offset Box	262
Double Box Ratcheting	238,239
E-Torx Ratcheting	242
Flare Nut	259
Flex Combination Ratcheting	222-225
Flex Flare Nut	258,260
Half-Moon Double Box Ratcheting	239,240
Indexing Ratcheting	232,233
Open End Non-Ratcheting	263
Open End Ratcheting	234,235
QuadBox Double Box Ratcheting	236,238
Reversible Combination Ratcheting	215-219
S-Shape Double Box Ratcheting	240,241
Stubby Combination Ratcheting	213, 214
Stubby Combination Non-Ratcheting	256,257
Stubby Flex Combination Ratcheting	226,227
XL Combination Ratcheting	202-206
XL GearBox Double Box Ratcheting	228-230
XL Locking Flex Combination Ratcheting	220,221
XL Spline Combination Wrenches	231
XL X-Beam Ratcheting	190-201
XL X-Beam Non-Ratcheting	245,246
X	
XL Combination Ratcheting	202-206
XL Locking Flex Combination Ratcheting	220,221
XL Pass-Thru Ratchet & Socket Sets	124-126
XL Spline Combination Wrenches	231
XL X-Beam Ratcheting	190-201
XL X-Beam Non-Ratcheting	245,246

NUMERICAL INDEX

ITEM NO.	PAGE
3680	351
3718	331
3719	331
3720	332
3722	332
3723	332
3724	332
3725	332
3870	351
3871	351
3872	352
3873	352
3874	352
3875	352
3876	352
3877	352
3880	342
3881	343
3882	343
3883	343
3884	343
3885	337
3886	338
3887	336
8906	298
8908	299
8909	299
8915	297
8916	298
8926	296
8939	295
8940	294
9008	211
9010	211
9011	211
9012	211
9014	211
9016	211
9018	211
9020	211
9022	211
9024	211
9026	211
9028	211
9030	211
9032	211
9034	211
9036	211
9038	211
9040	211
9042	211
9044	211
9046	211
9048	211
9050	211
9052	211
9054	211
9056	211
9060	211
9062	211
9106	212
9107	212
9108	212
9109	212

ITEM NO.	PAGE
9110	212
9111	212
9112	212
9113	212
9114	212
9115	212
9116	212
9117	212
9118	212
9119	212
9120	212
9121	212
9122	212
9124	212
9125	212
9127	212
9130	212
9132	212
9134	212
9136	212
9141	212
9146	212
9150	212
9201	239
9202	239
9203	239
9204	239
9207	239
9208	239
9209	239
9210	239
9211	239
9212	239
9213	239
9214	239
9215	239
9217	243
9218	243
9219	243
9220	224
9221	224
9222	224
9223	224
9224	224
9230	243
9231	243
9240	238
9260	238
9304	210
9308	208
9309	210
9312	207
9317	209
9404	210
9412	208
9413	209
9416	207
9417	209
9418	208
9500	214
9501	214
9502	214
9503	214
9504	214

ITEM NO.	PAGE
9505	214
9506	214
9507	213
9509	216
9509R	216
9510	214
9511	214
9512	214
9513	214
9514	214
9515	214
9516	214
9517	214
9518	214
9519	214
9520	213
9521	219
9525	219
9526	219
9527	219
9528	219
9529	219
9530	219
9531	219
9532	219
9533	217
9534	219
9535	243
9536	243
9537	242
9538	219
9539	219
9540	219
9543	218
9545	218
9550	226
9551	227
9552	227
9553	227
9554	227
9555	227
9556	227
9557	227
9558	227
9559	227
9560	227
9567R	218
9570	226
9571	227
9572	227
9573	227
9574	227
9575	227
9576	227
9577	227
9601	218
9601R	218
9602	215
9602R	215
9608	219
9609	219
9610	219
9611	219
9612	219

ITEM NO.	PAGE
9613	219
9614	219
9615	219
9616	219
9617	219
9618	219
9619	219
9620	217
9621	219
9622	219
9624	219
9625	219
9700	223
9701	223
9702	222
9703	224
9704	225
9705	225
9706	225
9707	225
9708	225
9709	225
9710	225
9711	225
9712	225
9713	225
9714	225
9715	225
9716	225
9840	239
9841	240
9842	240
9843	240
9844	240
9850	239
9851	240
9852	240
9853	240
9854	240
9855	240
9900	224
9901	223
9902	222
9903	224
9908	225
9909	225
9910	225
9911	225
9912	225
9913	225
9914	225
9915	225
9916	225
9917	225
9918	225
9919	225
9921	225
9922	225
9924	225
9925	225
80000	279
80001	279
80004	279
80005	279

ITEM NO.	PAGE
80006	279
80007	279
80009	279
80010	279
80011	279
80012	279
80013	279
80014	279
80015	279
80017	279
80018	279
80019	279
80020	279
80021	279
80022	279
80023	279
80024	280
80025	280
80026	280
80027	280
80028	280
80029	280
80030	280
80031	281
80032	281
80033	281
80034	281
80035	281
80036	281
80037	282
80038	282
80039	282
80040	282
80041	282
80042	282
80043	280
80044	280
80045	280
80046	280
80047	290
80048	290
80049	290
80050	275
80051	274
80052	275
80053	275
80054	276
80055	277
80056	277
80057	277
80058	304
80059	276
80060	278
80061	278
80062	315
80063	289
80064	276
80065	278
80066	274
80072	292
80080	290
80081	290
80082	290
80083	290
80084	290
80085	290
80086	280

ITEM NO.	PAGE
80087	280
80088	280
80089	281
80090	281
80091	281
80092	281
80100	69
80101	166
80104	72
80105	72
80106	72
80107	72
80108	72
80109	72
80110	72
80111	72
80112	72
80113	72
80114	72
80115	74
80116	74
80117	74
80118	74
80119	74
80120	74
80121	74
80122	74
80123	74
80124	74
80125	72
80126	72
80127	72
80128	72
80129	73
80130	73
80131	73
80132	73
80133	73
80134	73
80135	73
80136	73
80137	73
80138	74
80139	74
80140	74
80141	74
80142	74
80143	74
80144	75
80145	75
80146	75
80147	75
80148	75
80149	75
80150	75
80151	144
80152	144
80153	144
80154	144
80155	144
80156	144
80157	144
80158	144
80159	144
80160	144
80161	144
80162	144

ITEM NO.	PAGE
80163	144
80164	144
80165	144
80166	144
80167	144
80168	144
80169	144
80170	144
80171	145
80172	145
80173	145
80174	145
80175	145
80176	145
80177	145
80178	145
80179	145
80180	145
80181	145
80182	145
80183	145
80184	145
80185	145
80186	146
80187	146
80188	146
80189	146
80190	146
80191	146
80192	146
80193	146
80194	146
80195	146
80196	146
80197	73
80198	73
80199	73
80200	73
80201	73
80202	73
80203	73
80204	73
80205	73
80206	73
80207	73
80208	73
80209	73
80210	72
80211	72
80212	72
80213	72
80214	72
80215	72
80216	72
80217	72
80218	72
80219	72
80220	74
80221	74
80222	74
80223	74
80224	74
80225	74
80226	74
80227	74
80228	74
80229	74

ITEM NO.	PAGE
80230	75
80231	75
80232	75
80233	75
80234	75
80235	75
80236	75
80237	75
80238	75
80239	75
80240	75
80241	75
80242	75
80250	76
80251	76
80252	76
80253	76
80254	76
80255	76
80256	76
80257	76
80258	76
80259	76
80260	76
80261	76
80262	76
80263	76
80264	76
80265	76
80266	76
80267	76
80268	76
80290	72
80300	58
80301	59
80302	66
80303	65
80304	67
80305	65
80306	66
80307	65
80308	67
80309	66
80310	67
80311	68
80312	60
80313	61
80314	64
80320	140
80321	139
80322	140
80323	139
80324	63
80325	62
80326	63
80327	62
80330	96
80331	96
80332	96
80333	99
80334	99
80335	99
80336	99
80337	99
80338	99
80339	99
80340	99

ITEM NO.	PAGE
80341	99
80342	99
80343	99
80344	99
80345	99
80346	99
80347	99
80348	99
80349	99
80350	95
80351	95
80352	95
80353	95
80354	95
80355	95
80356	95
80357	95
80358	95
80359	95
80360	95
80361	95
80362	95
80363	97
80364	97
80365	97
80366	97
80367	97
80368	97
80369	97
80370	97
80371	97
80372	97
80373	97
80374	95
80375	95
80376	95
80377	95
80378	96
80379	96
80380	96
80381	96
80382	96
80383	96
80384	96
80385	96
80386	96
80387	96
80388	98
80389	98
80390	98
80391	98
80392	98
80393	98
80394	98
80395	98
80396	98
80397	98
80398	98
80399	98
80400	98
80401	98
80402	94
80403	94
80404	94
80405	94
80406	98
80407	98

ITEM NO.	PAGE
80408	98
80409	98
80410	148
80411	148
80412	148
80413	148
80414	148
80415	148
80416	148
80417	148
80418	148
80419	148
80420	148
80421	148
80422	148
80423	148
80424	148
80425	148
80426	148
80427	148
80428	148
80429	148
80430	148
80431	148
80432	148
80433	148
80434	149
80435	149
80436	149
80437	149
80438	149
80439	149
80440	149
80441	149
80442	149
80443	149
80444	149
80445	149
80446	149
80447	149
80448	149
80449	150
80450	150
80451	151
80452	151
80453	151
80454	151
80455	151
80456	151
80457	151
80458	151
80459	151
80460	152
80461	152
80462	152
80463	152
80464	153
80465	153
80466	153
80467	153
80468	153
80469	153
80470	153
80471	147
80472	147
80473	147
80474	147

ITEM NO.	PAGE
80475	147
80476	147
80477	152
80478	152
80479	152
80480	147
80481	152
80482	96
80483	96
80484	96
80485	96
80486	96
80487	96
80488	96
80489	96
80490	96
80491	96
80492	96
80493	96
80494	96
80495	96
80496	95
80497	95
80498	95
80499	95
80500	95
80501	95
80502	95
80503	95
80504	95
80505	95
80506	95
80507	95
80508	95
80509	97
80510	97
80511	97
80512	97
80513	97
80514	97
80515	97
80516	97
80517	97
80518	97
80519	97
80520	98
80521	98
80522	98
80523	98
80524	98
80525	98
80526	98
80527	98
80528	98
80529	98
80530	98
80531	98
80532	98
80533	98
80534	151
80535	151
80536	151
80537	151
80538	151
80539	150
80540	150
80541	150

ITEM NO.	PAGE
80542	150
80543	150
80544	150
80545	150
80546	94
80547	94
80548	173
80549	92
80550	77
80551	78
80552	88
80553	87
80554	89
80555	87
80556	85
80557	82
80558	85
80559	82
80560	88
80561	87
80562	89
80563	88
80564	89
80565	90
80566	80
80567	79
80568	81
80569	81
80570	143
80571	143
80572	139
80573	142
80574	142
80577	142
80578	138
80579	138
80580	140
80581	140
80582	138
80583	136
80584	84
80585	292
80586	141
80587	141
80588	137
80589	84
80590	83
80591	83
80592	97
80593	97
80594	97
80595	97
80596	96
80597	96
80598	96
80600	114
80602	116
80603	116
80604	116
80605	116
80606	116
80607	116
80608	116
80609	116
80610	116
80611	116
80612	116

ITEM NO.	PAGE
80613	116
80614	118
80615	118
80616	118
80617	118
80618	118
80619	118
80620	118
80621	118
80622	117
80623	117
80624	117
80625	117
80626	117
80627	117
80628	117
80629	117
80630	117
80631	117
80632	117
80633	117
80634	117
80635	117
80636	117
80637	119
80638	119
80639	119
80640	119
80641	119
80642	119
80643	119
80644	119
80645	119
80646	119
80651	153
80652	153
80653	153
80654	153
80655	153
80656	153
80657	153
80658	153
80659	153
80660	153
80661	153
80662	153
80663	153
80664	153
80665	154
80666	154
80667	154
80668	155
80669	155
80670	155
80671	182
80672	155
80673	155
80674	118
80675	118
80676	118
80677	116
80678	116
80679	116
80680	116
80681	117
80682	117
80683	117

ITEM NO.	PAGE
80684	118
80685	118
80686	118
80687	118
80700	100
80701	101
80702	111
80703	109
80704	112
80705	111
80706	106
80707	104
80708	106
80709	104
80710	112
80711	109
80712	112
80713	111
80714	103
80715	102
80716	105
80717	105
80718	86
80720	143
80721	143
80722	137
80723	136
80724	137
80725	136
80726	134
80727	134
80729	107
80730	108
80731	109
80732	110
80733	110
80745	117
80746	117
80747	117
80748	117
80749	117
80750	117
80751	117
80752	117
80753	117
80754	117
80755	117
80756	117
80757	117
80758	117
80759	117
80760	116
80761	116
80762	116
80763	116
80764	116
80765	116
80766	116
80767	116
80768	116
80769	116
80770	116
80771	116
80772	118
80773	118
80774	118
80775	118

ITEM NO.	PAGE
80776	118
80777	118
80778	118
80779	118
80780	118
80781	119
80782	119
80783	119
80784	119
80785	119
80786	119
80787	119
80788	119
80789	119
80790	119
80793	116
80794	116
80795	118
80796	118
80797	118
80798	118
80805	117
80806	117
80811	117
80812	117
80813	117
80814	117
80815	117
80817	119
80818	119
80820	119
80822	119
80824	119
80826	119
80827	119
80830	122
80831	122
80833	122
80834	122
80835	122
80838	122
80839	122
80840	122
80841	122
80852	122
80854	122
80855	122
80856	122
80857	122
80859	122
80860	122
80861	122
80862	122
80863	122
80864	122
80865	122
80879	120
80880	120
80929	54
80930	52
80931	48
80932	46
80933	43
80934	40
81002	70
81003	71
81004	71

ITEM NO.	PAGE
81007	68
81008	69
81009	68
81011	68
81012	68
81013	69
81014	68
81099	69
81101	70
81113	70
81114	70
81116	70
81117	70
81118	70
81119	71
81120	71
81121	71
81122	71
81123	71
81124	71
81125	71
81126	71
81127	70
81128	69
81200	93
81201	93
81202	94
81203	55
81204	56
81205	56
81206	55
81207	55
81208	91
81209	90
81210	91
81211	90
81212	91
81213	92
81214	91
81215	90
81216	55
81217	56
81218	91
81219	91
81221	92
81222	56
81223	56
81224	69
81225	92
81226	92
81227	92
81229	90
81230	54
81231	57
81232	69
81233	92
81234	114
81235	57
81236	57
81237	57
81238	57
81239	93
81240	93
81241	93
81242	93
81243	93
81244	93

ITEM NO.	PAGE
81245	94
81246	94
81247	94
81248	94
81249	94
81250	94
81251	94
81255	70
81256	93
81257	114
81258	70
81259	94
81260	94
81261	70
81262	93
81263	115
81272	94
81277	94
81278	94
81300	114
81301	115
81302	115
81303	113
81304	112
81306	113
81307	113
81308	113
81309	113
81310	55
81311	113
81312	113
81339	113
81340	115
81341	115
81342	115
81343	115
81344	115
81345	115
81346	115
81347	115
81348	115
81349	115
81350	115
81354	114
81355	114
81400	121
81401	121
81404	121
81411	121
81412	121
81413	121
81499	121
81603	261
81604	261
81605	261
81606	261
81607	261
81608	261
81609	261
81610	261
81611	261
81612	261
81613	261
81614	261
81615	261
81616	261
81617	261

ITEM NO.	PAGE
81618	261
81619	261
81620	261
81621	261
81622	261
81623	261
81624	257
81625	257
81626	257
81627	257
81628	257
81629	257
81630	257
81631	257
81632	257
81633	257
81634	257
81635	257
81636	257
81637	257
81638	257
81639	257
81640	257
81641	257
81642	257
81643	257
81644	259
81645	259
81646	259
81647	259
81648	259
81649	259
81650	252
81651	252
81652	252
81653	252
81654	252
81655	252
81656	252
81657	252
81658	252
81659	252
81660	252
81661	252
81662	252
81663	252
81664	252
81665	252
81666	252
81667	252
81668	252
81669	252
81670	252
81671	252
81672	252
81673	252
81674	253
81675	253
81676	253
81677	253
81678	253
81679	253
81680	259
81681	259
81682	259
81683	259
81684	259

ITEM NO.	PAGE
81685	259
81686	260
81687	260
81688	260
81689	260
81690	260
81692	260
81693	260
81694	260
81695	260
81696	260
81697	260
81698	246
81699	246
81700	246
81701	246
81703	246
81705	246
81706	246
81707	246
81709	246
81710	246
81711	246
81713	246
81714	246
81715	246
81717	246
81718	246
81719	246
81721	246
81722	246
81723	246
81725	246
81733	252
81734	252
81735	252
81736	252
81737	252
81741	253
81742	253
81743	253
81744	253
81745	253
81749	252
81750	252
81751	253
81752	253
81753	253
81754	255
81755	255
81756	255
81757	255
81758	255
81759	255
81760	255
81761	255
81762	255
81763	255
81764	255
81765	255
81766	255
81767	255
81768	255
81769	255
81770	255
81771	255
81772	255

ITEM NO.	PAGE
81773	255
81774	255
81775	255
81776	255
81777	255
81778	255
81779	255
81780	255
81781	255
81782	262
81783	262
81784	262
81785	262
81786	262
81787	262
81788	262
81789	262
81790	262
81791	262
81792	263
81793	263
81794	263
81795	263
81796	263
81797	263
81798	263
81799	263
81801	263
81802	263
81803	263
81804	263
81805	263
81870	265
81871	265
81872	265
81873	265
81874	265
81875	265
81876	265
81877	265
81880	265
81881	265
81882	265
81883	265
81884	265
81885	265
81886	265
81887	265
81890	264
81891	264
81892	264
81893	264
81900	248
81901	248
81902	250
81903	256
81904	257
81905	256
81906	259
81907	259
81908	260
81909	261
81910	258
81911	258
81912	245
81913	245
81914	258

ITEM NO.	PAGE
81915	258
81916	250
81917	249
81918	249
81919	247
81920	251
81921	251
81922	251
81923	253
81924	254
81925	254
81926	262
81927	262
81928	263
81929	263
81990	264
81991	264
81992	264
81993	265
81999	307
82000	307
82001	307
82002	307
82003	308
82004	308
82005	309
82006	309
82007	310
82008	306
82009	348
82010	306
82011	305
82012	305
82013	306
82014	305
82017	310
82018	310
82019	310
82020	305
82022	305
82025	306
82028	306
82029	316
82030	316
82031	316
82032	310
82033	310
82034	311
82035	311
82038	306
82040	317
82041	317
82042	317
82043	317
82044	317
82045	317
82046	317
82047	317
82048	317
82049	317
82050	317
82051	317
82052	317
82053	317
82078	315
82079	312
82080	312

ITEM NO.	PAGE
82081	313
82082	313
82083	313
82084	314
82085	313
82086	313
82087	314
82088	314
82089	314
82090	314
82092	312
82093	312
82094	312
82095	312
82096	315
82097	311
82098	311
82099	312
82100	305
82102	316
82103	304
82104	304
82106	308
82107	308
82108	304
82110	309
82111	309
82112	317
82200	331
82208	322
82210	322
82212	322
82216	322
82220	322
82224	322
82233	322
82248	322
82250	325
82251	325
82252	325
82253	325
82254	325
82255	326
82256	327
82257	327
82258	327
82259	326
82260	326
82261	327
82262	327
82263	327
82264	327
82265	327
82266	327
82267	327
82268	327
82269	330
82270	330
82271	330
82272	330
82273	330
82274	330
82275	330
82276	330
82277	330
82278	330
82279	330

ITEM NO.	PAGE
82280	330
82281	330
82282	330
82283	330
82284	330
82285	330
82286	330
82287	330
82288	325
82289	326
82291	326
82300	322
82301	322
82302	331
82303	325
82304	328
82305	328
82306	327
82307	329
82308	328
82309	329
82401	156
82411	156
82421	156
82500	150
82501	150
82502	150
82503	150
82504	150
82505	150
82506	150
82510	147
82511	147
82512	147
82513	147
82514	147
82515	147
82516	147
82517	152
82518	152
82519	152
82700	284
82701	285
82702	284
82703	284
82704	284
82705	284
82706	284
82707	284
82708	284
82709	284
82710	284
82711	285
82712	285
82713	285
82714	285
82715	285
82716	285
82717	285
82718	285
82719	285
82720	285
82721	285
82730	282
82731	283
82732	283
82733	284

ITEM NO.	PAGE
82734	283
82750	288
82751	288
82752	288
82753	288
82754	288
82755	288
82756	288
82757	288
82758	288
82759	288
82760	288
82761	288
82762	288
82763	288
82764	287
82765	286
82770	286
82772	287
82773	287
82774	287
82775	287
82776	287
82777	287
82780	297
82781	298
82782	286
82783	292
82784	293
82791	292
82792	292
82793	292
82800	343
82801	343
82802	343
82803	343
82804	343
82805	343
82806	342
82807	342
82808	341
82809	341
82810	340
82811	339
82812	335
82820	346
82821	346
82822	347
82823	347
82824	347
82825	347
82826	347
82827	347
82828	347
82829	347
82830	347
82831	347
82840	348
82841	348
82842	348
82843	348
82850	344
82851	344
82852	344
82853	344
82854	344
82855	344

ITEM NO.	PAGE
82856	344
82857	344
82858	344
82859	344
82860	344
82861	344
82862	344
82863	344
82864	344
82865	344
82866	344
82867	344
82868	344
82869	344
82880	346
82881	346
82900	289
82901	289
82902	291
82903	291
82904	291
82905	291
82906	291
82907	291
82908	291
82909	291
82910	291
82911	291
82912	291
82913	291
82914	291
82915	291
82916	291
82917	291
83000	53
83001	50
83080	24
83090	13
83091	14
83092	16
83093	16
83094	17
83095	18
83096	22
83097	20
83098	25
83101	36
83102	36
83103	36
83104	36
83105	36
83106	36
83107	36
83108	36
83109	36
83110	36
83111	36
83112	36
83113	36
83114	36
83115	36
83130	35
83131	355
83132	356
83147	35
83148	35
83151	35

ITEM NO.	PAGE
83152	32
83153	32
83154	31
83155	31
83156	30
83157	30
83158	30
84000	352
84001	353
84002	353
84003	353
84004	353
84005	353
84006	353
84007	353
84040	352
84050	354
84051	355
84052	355
84053	355
84054	355
84060	354
84061	354
84062	354
84070	354
84071	354
84072	354
84080	354
84081	354
84082	354
84083	354
84084	354
84090	329
84100	166
84101	166
84102	166
84103	166
84104	166
84105	166
84106	166
84107	166
84108	166
84109	166
84111	166
84112	166
84113	166
84114	166
84115	166
84116	166
84117	166
84118	166
84119	166
84120	166
84121	166
84122	166
84123	166
84124	166
84126	167
84127	167
84128	167
84129	167
84130	167
84131	167
84132	167
84133	167
84134	167
84135	167

ITEM NO.	PAGE
84137	167
84138	167
84139	167
84140	167
84141	167
84142	167
84143	167
84144	167
84145	167
84146	167
84147	167
84148	167
84149	167
84150	167
84152	168
84153	168
84154	168
84155	168
84156	168
84157	168
84159	168
84160	168
84161	168
84162	168
84163	168
84164	168
84165	168
84166	168
84167	168
84168	168
84169	168
84170	168
84172	165
84173	165
84174	165
84176	166
84300	173
84301	173
84302	173
84303	173
84304	173
84305	173
84306	173
84307	173
84309	173
84310	173
84311	173
84312	173
84313	173
84314	173
84315	173
84316	173
84317	173
84318	173
84319	173
84320	173
84322	174
84323	174
84324	174
84325	174
84326	174
84327	174
84328	174
84329	174
84331	174
84332	174
84333	174

ITEM NO.	PAGE
84334	174
84335	174
84336	174
84337	174
84338	174
84339	174
84340	174
84341	174
84342	174
84343	174
84345	176
84346	176
84347	176
84348	176
84349	176
84350	176
84351	176
84352	176
84354	176
84355	176
84356	176
84357	176
84358	176
84359	176
84360	176
84361	176
84362	176
84363	176
84364	176
84365	176
84366	176
84367	176
84368	176
84389	175
84390	175
84391	175
84392	175
84393	175
84394	175
84395	175
84397	175
84398	175
84399	175
84400	175
84401	175
84402	175
84403	175
84405	172
84406	172
84407	172
84408	172
84500	183
84501	183
84502	183
84503	183
84504	183
84505	183
84506	183
84507	183
84508	183
84509	183
84510	183
84511	183
84512	183
84513	183
84514	183
84515	184

ITEM NO.	PAGE
84516	184
84517	184
84518	184
84520	184
84521	184
84522	184
84523	184
84524	184
84525	184
84526	184
84527	184
84528	184
84529	184
84530	184
84531	184
84532	184
84533	184
84534	184
84535	184
84536	184
84537	184
84538	184
84539	184
84540	184
84540	184
84542	184
84543	184
84544	184
84546	185
84547	185
84548	185
84549	185
84550	185
84551	185
84552	185
84553	185
84554	185
84555	185
84556	185
84557	185
84558	185
84559	185
84560	185
84561	185
84562	185
84563	185
84564	185
84566	185
84567	185
84568	185
84569	185
84570	185
84571	185
84572	186
84573	186
84574	186
84575	186
84576	186
84577	186
84578	186
84579	186
84580	186
84581	186
84582	186
84583	186
84584	186
84585	186

ITEM NO.	PAGE
84586	186
84587	186
84588	186
84589	186
84590	186
84591	186
84592	186
84593	186
84594	186
84596	188
84597	188
84598	188
84599	188
84600	188
84601	188
84602	188
84603	188
84604	188
84605	188
84606	188
84607	188
84608	188
84610	188
84611	188
84612	188
84613	188
84614	188
84615	188
84616	188
84617	188
84618	188
84619	188
84620	188
84621	188
84622	188
84623	188
84624	188
84626	187
84627	187
84628	187
84629	187
84630	187
84631	187
84632	187
84634	187
84635	187
84636	187
84637	187
84638	187
84639	187
84640	187
84643	182
84644	182
84645	182
84646	182
84800	190
84801	190
84802	190
84803	190
84804	190
84805	190
84806	190
84807	190
84808	190
84809	190
84810	190
84811	190

ITEM NO.	PAGE
84812	190
84813	190
84814	190
84815	190
84816	190
84817	190
84818	190
84819	190
84820	190
84821	190
84822	190
84823	190
84824	190
84825	190
84826	190
84827	190
84828	190
84830	190
84831	190
84832	191
84833	191
84834	191
84835	191
84836	191
84837	191
84838	191
84839	191
84840	191
84841	191
84842	191
84843	191
84844	191
84845	191
84846	191
84847	191
84848	191
84849	191
84850	191
84851	191
84852	191
84853	191
84854	191
84855	191
84856	191
84857	191
84858	191
84859	191
84860	191
84861	191
84863	192
84864	192
84865	192
84866	192
84867	192
84868	192
84869	192
84870	192
84871	192
84872	192
84873	192
84874	192
84875	192
84876	192
84877	192
84878	192
84879	192
84880	192

ITEM NO.	PAGE
84881	192
84882	192
84883	192
84885	189
84886	189
84887	189
84888	189
84900	163
84901	163
84902	162
84903	161
84904	165
84905	165
84906	164
84907	164
84908	164
84909	165
84910	170
84911	170
84912	171
84913	171
84914	171
84915	170
84916	169
84917	172
84918	172
84930	177
84931	177
84932	177
84933	178
84934	179
84935	180
84938	181
84939	181
84940	180
84941	181
84942	178
84944	179
85006	206
85007	206
85008	206
85009	206
85010	206
85011	206
85012	206
85013	206
85014	206
85015	206
85016	206
85017	206
85018	206
85019	206
85020	206
85021	206
85022	206
85024	206
85050	269
85051	269
85052	269
85053	269
85054	269
85055	269
85056	269
85057	269
85070	269
85071	269
85072	269

ITEM NO.	PAGE
85073	269
85074	269
85075	270
85098	204
85099	202
85108	206
85110	206
85112	206
85114	206
85116	206
85118	206
85120	206
85122	206
85124	206
85126	206
85128	206
85130	206
85132	206
85198	205
85199	203
85200	236
85201	237
85202	237
85203	237
85204	237
85210	236
85211	237
85212	237
85213	237
85214	237
85215	237
85220	238
85221	238
85222	241
85224	241
85230	241
85232	241
85241	241
85258	201
85259	201
85260	201
85261	201
85262	201
85263	201
85264	201
85265	201
85266	201
85267	201
85268	201
85269	201
85270	201
85271	201
85272	201
85274	201
85276	201
85278	201
85280	201
85282	201
85284	201
85288	197
85298	197
85299	240
85308	200
85309	200
85310	200
85311	200
85312	200

ITEM NO.	PAGE
85313	200
85314	200
85315	200
85316	200
85317	200
85318	200
85319	200
85326	241
85334	241
85342	241
85352	241
85360	200
85361	200
85362	200
85364	200
85366	200
85368	200
85370	200
85372	200
85374	200
85388	198
85398	198
85399	241
85418	233
85439	233
85440	233
85441	233
85442	233
85443	233
85444	233
85445	233
85446	233
85447	233
85448	233
85449	233
85450	233
85452	233
85454	233
85456	233
85458	233
85460	233
85462	233
85464	233
85488	232
85498	232
85508	235
85509	235
85510	235
85511	235
85512	235
85513	235
85514	235
85515	235
85516	235
85517	235
85518	235
85519	235
85548	231
85550	231
85552	231
85554	231
85556	231
85558	231
85560	231
85562	231
85564	231
85570	235

ITEM NO.	PAGE
85572	235
85574	235
85576	235
85578	235
85580	235
85582	235
85584	235
85597	234
85598	231
85599	234
85608	221
85609	221
85610	221
85611	221
85612	221
85613	221
85614	221
85615	221
85616	221
85617	221
85618	221
85619	221
85698	220
85710	221
85712	221
85714	221
85716	221
85718	221
85720	221
85722	221
85724	221
85798	220
85808	199
85809	199
85810	199
85811	199
85812	199
85813	199
85814	199
85815	199
85816	199
85817	199
85818	199
85819	199
85850	199
85851	199
85852	199
85854	199
85856	199
85858	199
85860	199
85862	199
85864	199
85888	196
85898	196
85908	230
85909	230
85910	230
85911	230
85912	230
85913	230
85914	230
85915	230
85916	230
85917	230
85918	230
85919	230

ITEM NO.	PAGE
85920	230
85921	230
85922	230
85924	230
85925	230
85950	230
85951	230
85952	230
85954	230
85956	230
85958	230
85960	230
85962	230
85964	230
85966	230
85968	230
85970	230
85972	230
85987	228
85988	228
85989	228
85996	229
85998	229
85999	229
86990	356
86991	356
89001	129
89002	129
89003	129
89004	129
89005	129
89006	129
89007	129
89008	129
89009	129
89010	129
89011	129
89012	129
89013	129
89014	129
89015	129
89016	129
89017	129
89018	129
89019	129
89020	129
89021	129
89022	129
89023	129
89024	129
89025	129
89026	129
89027	129
89028	129
89029	129
89030	129
89031	129
89032	129
89033	129
89034	129
89035	129
89036	129
89037	129
89038	129
89039	129
93004	210
93005	209

ITEM NO.	PAGE
368071	351
368072	351
368073	351
368074	351
368075	351
368076	351
368077	351
368078	351
368079	351
368080	351
368081	351
368082	351
368083	351
368084	351
368085	351
388701	344
388702	344
388703	344
388704	344
388705	344
388706	344
388707	344
388708	344
388709	344
388710	344
388711	344
388712	344
388713	344
388714	344
388715	344
388716	344
388717	344
388718	344
388719	344
388720	344
388721	344
388722	344
388723	344
388724	344
388725	344
388726	344
388727	344
388728	344
388729	344
388730	344
388731	344
388732	344
388733	344
388734	344
388735	344
388736	344
388737	344
388738	344
388739	344
388740	344
388741	344
388742	344
388743	344
388744	344
388745	344
388746	344
388747	344
388748	344
388749	344
388750	344
388751	344
388752	344

ITEM NO.	PAGE
388753	344
388754	344
388755	344
388756	344
388757	344
388758	344
388759	344
388760	344
388761	344
388762	344
388763	344
388764	344
388765	344
388766	344
388767	344
388768	344
890040	126
891200	126
891226	125
891400	126
891427	124
893800	126
893823	125
122050GR	127
122060GR	127
122070GR	127
122080GR	127
122090GR	127
122100GR	127
122120GR	127
122140GR	127
122160GR	127
122180GR	127
132120GR	127
132140GR	127
132160GR	127
132180GR	127
132200GR	127
132220GR	127
132240GR	127
132260GR	127
132280GR	127
142200GR	128
142220GR	128
142240GR	128
142260GR	128
142280GR	128
142300GR	128
142320GR	128
142340GR	128
142360GR	128
142380GR	128
221060GR	130
221080GR	130
231060GR	130
231061GR	130
231062GR	130
231080GR	130
235080GR	351
241062GR	130
241080GR	130
310901GR	300
310902GR	300
310903GR	300
311901GR	300
311902GR	300
311903GR	300

ITEM NO.	PAGE
311904GR	300
312901GD	299
45053C	157
45054C	157
45055C	157
45056C	157
45057C	157
45080C	157
45081C	157
45082C	157
45085C	157
45087C	157
45089C	157
45090C	157
45091C	157
45092C	157
45093C	157
45094C	157
45095C	157
522040GR	127
522050GR	127
522060GR	127
522070GR	127
522080GR	127
522090GR	127
522100GR	127
522110GR	127
522120GR	127
522130GR	127
522350GR	127
522450GR	127
522550GR	127
532100GR	127
532110GR	127
532120GR	127
532130GR	127
532140GR	127
532150GR	127
532160GR	127
532170GR	127
532180GR	127
532190GR	127
542150GR	128
542160GR	128
542170GR	128
542180GR	128
542190GR	128
542200GR	128
542210GR	128
542220GR	128
542240GR	128
542270GR	128
542300GR	128
542320GR	128
80300BM	58
80550BM	77
80700BM	100
83000BM	53
83001BM	51
83122BK	34
83122BU	34
83122RD	34
83123BK	34
83123BU	34
83123RD	34
83124BK	34
83124BU	34

ITEM NO.	PAGE
83124RD	34
83125BK	34
83125BU	34
83125RD	34
83126BK	33
83126BU	33
83126OR	33
83126RD	33
83127BK	33
83127BU	33
83127OR	33
83127RD	33
85090R	204
85099R	202
85197R	205
85199R	203
85698R	220
85798R	220
890001GD	300
890002GD	299
890003GD	299
890004GD	299
890005GD	300
890006GD	300
890007GD	299
890008GD	300
890009GD	300
890010GD	299
890060GD	300
890080GD	300
890100GD	300
890110GD	300
890120GD	300
890140GD	300
890160GD	300
891050GD	300
891060GD	300
891070GD	300
891080GD	300
891090GD	300
891100GD	300
891110GD	300
891120GD	300

AVAILABLE NOW!

Get more access and leverage with the complete offering of the indexing pry bar family of product — ranging from 8 to 48 inches!

FITS HERE. AND HERE.

EXCEEDS 5X ANSI REQUIREMENTS!!!

Withstands over
19,000 inch lbs of force !!!

The new GearWrench® 48" Extendable Pry Bar gives you all the leverage you need -- and the security, too.

 **GEARWRENCH®**

www.labem.pl

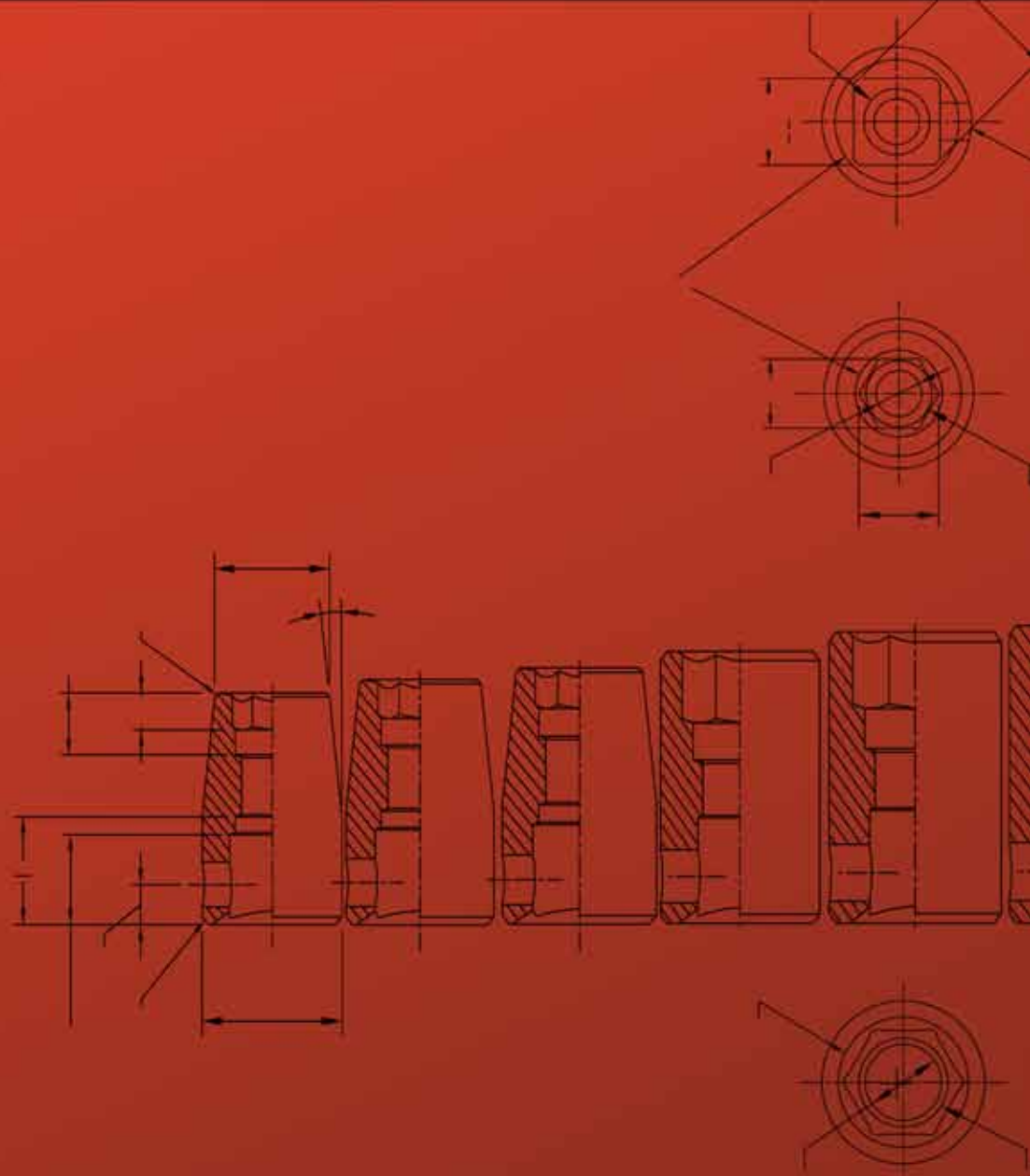

CATALOG NO. 1400

Danaher Tool Group
Sparks, MD 21152

Customer Service
Phone: 800-688-8949
Fax: 800-234-0472

www.gearwrench.com

Form No. 89110-90
Printed in U.S.A.
Copyright © 2010
Danaher Corporation
All rights reserved.